



Broggi 1818

Hospitality 2026



Broggi Hospitality 2026

Sommario

La Storia	006
The Story	
Posateria	013
Flatware	
Contemporary - Stainless Steel.....	016
Classic - Stainless Steel.....	042
Posate Alpacca - EPNS.....	067
Complementi.....	089
Mix&Match.....	106
Finiture speciali	114
Special finishes	
Posateria - Flatware.....	114
Vasellame - Hollowware.....	134
Vasellame	134
Hollowware	
Essenza.....	144
Zeta.....	172
Decò.....	186
Veneto / Iseo.....	190
Classica Alpacca - EPNS.....	234
Rubans Alpacca - EPNS.....	270
Vassoio in fibra di carbonio - Carbon fibre tray.....	284
Bento.....	290
PiGreco.....	298
Light	308
Light	
Decò.....	308
Venus.....	310
Bugia.....	312
Nuvola.....	314
Gennaro	318
Gennaro	
Aqva	320
Aqva	
Buffet	326
Buffet	
Decò.....	328
Nature.....	350
Zeta.....	382
Scaldavivande.....	396
Manhattan.....	404
Classica.....	416
Sistema Rail	430
System Rail	
Carrelli	452
Trolleys	
PiGreco.....	452
Linea.....	468
Classica.....	474

Il marchio Broggi

Broggi rappresenta una solida realtà industriale, parte della storica Società Abert dal 1993, insieme all'omonimo marchio. Leader in Italia e a livello internazionale, Abert eccelle nella produzione di posate, vasellame, buffet, prodotti professionali Ho.Re.Ca. e accessori per la tavola e la cucina. Sotto la guida della famiglia Bertoli, generazione dopo generazione, l'azienda ha maturato una crescente sensibilità verso le evoluzioni del mercato, investendo in nuove tecnologie senza mai perdere i tratti distintivi dello stile aziendale. Anche grazie a questa unione, Broggi preserva la propria tradizione artigianale e il suo stile inconfondibile, arricchendosi dell'esperienza e delle risorse del gruppo, con un'attenzione particolare all'hospitality, intesa come fornitura d'alta gamma per hotellerie e ristorazione d'eccellenza. Oggi i due brand Broggi e Abert, ciascuno con una propria identità distintiva, rispondono in modo puntuale e completo a un'ampia gamma di esigenze nei settori della posateria, del vasellame, del buffet e dei complementi per la tavola, rivolgendosi ai canali Ho.Re.Ca. e Retail.

Chi siamo

Dal 1818 Broggi racconta una storia di prestigio senza tempo, creando posate e vasellame in acciaio e alpaca, buffet, carrelli e complementi per la tavola capaci di far rivivere e attualizzare lo stile esclusivo delle tavole più raffinate, soprattutto nei contesti dell'hospitality di alto livello. In ogni prodotto Broggi è racchiuso l'heritage dei maestri argentieri d'altri tempi: una sapiente miscela di passione, cura dei dettagli e perfezione delle forme capace di creare mise en place impeccabili per ristoranti e alberghi di alto livello. Marchio storico dalla lunga tradizione artigianale, pur rispettando le linee guida originarie, Broggi non rimane ancorato al ricordo degli sfarzi passati e crede nell'importanza di un'evoluzione continua e dinamica. Accanto ai decori e ai rilievi delle collezioni storiche che hanno lasciato il segno nella tradizione alberghiera internazionale, oggi Broggi si apre al futuro. Dallo sguardo alle nuove tendenze alla ricerca di materiali contemporanei, dalla sfida di portare sulle moderne tavole minimaliste i design delle posate di altri tempi, allo studio di nuove collezioni destinate a creare nuovi classici.

Punti di forza

Consulenza su misura: Broggi mette il cliente al centro offrendo non solo un prodotto, ma un vero servizio di consulenza. Non si tratta di una semplice vendita, ma di un rapporto di fiducia dove l'azienda è costantemente presente per ascoltare le esigenze del cliente, comprendere ciò di cui ha davvero bisogno e guidarlo nella scelta della soluzione più adatta.

Innovazione e ampio assortimento: da sempre attenta alle dinamiche del mercato globale, Broggi si distingue per un ampio assortimento di prodotti, spesso nati da collaborazioni di valore con partner internazionali. Grazie a una rete di fornitori qualificati, Broggi può contare su materiali innovativi e conoscenze specialistiche che assicurano elevati standard produttivi. L'esperienza nel Made in Italy e il know-how distintivo trasmesso ai partner garantiscono che ogni prodotto rispetti i criteri di eccellenza e la tradizione di qualità che ha sempre caratterizzato Broggi, rendendo l'innovazione parte integrante del processo aziendale.

Personalizzazione: Broggi offre un'ampia gamma di servizi per soddisfare le esigenze specifiche di ogni cliente, attraverso la realizzazione di prodotti esclusivi con un servizio attento e dedicato: dalla possibilità di personalizzare articoli con incisioni, punzonature e applicazioni a rilievo, fino ai dettagli personalizzati delle collezioni di vasellame, tra cui maniglie, bordure, manici e beccucci. A ciò si aggiunge la possibilità di realizzare decorazioni uniche su porcellana e bicchieri, con soluzioni creative che arricchiscono ogni servizio con un tocco di eleganza esclusiva. Broggi permette anche la realizzazione di prodotti su misura partendo dalle necessità specifiche del cliente, con la possibilità di scegliere tra diverse finiture e modifiche sostanziali. Infine, per i pezzi storici in alpaca, Broggi mette a disposizione un servizio di restauro che restituisce nuova vita agli oggetti, ripristinandone il fascino e mantenendo intatto il valore.

Design: dal fascino senza tempo delle linee più classiche ai tratti minimali delle tavole di oggi, dai decori che evocano i fasti passati alle superfici lisce degli ambienti contemporanei. Il design italiano di Broggi conserva la memoria del passato, ma con lo sguardo sempre rivolto al futuro.

Tradizione, artigianalità e cura dei dettagli: Broggi unisce la maestria dei tradizionali argentieri con una continua evoluzione del design, rinnovando nel presente il valore storico del marchio. La collezione di classici evoluti si inserisce perfettamente nei contesti moderni di ristoranti e boutique hotel, mantenendo viva l'essenza della tradizione. L'azienda conserva ancora oggi la cura dei dettagli che ha fatto di Broggi un punto di riferimento per la personalizzazione delle tavole più prestigiose del passato.

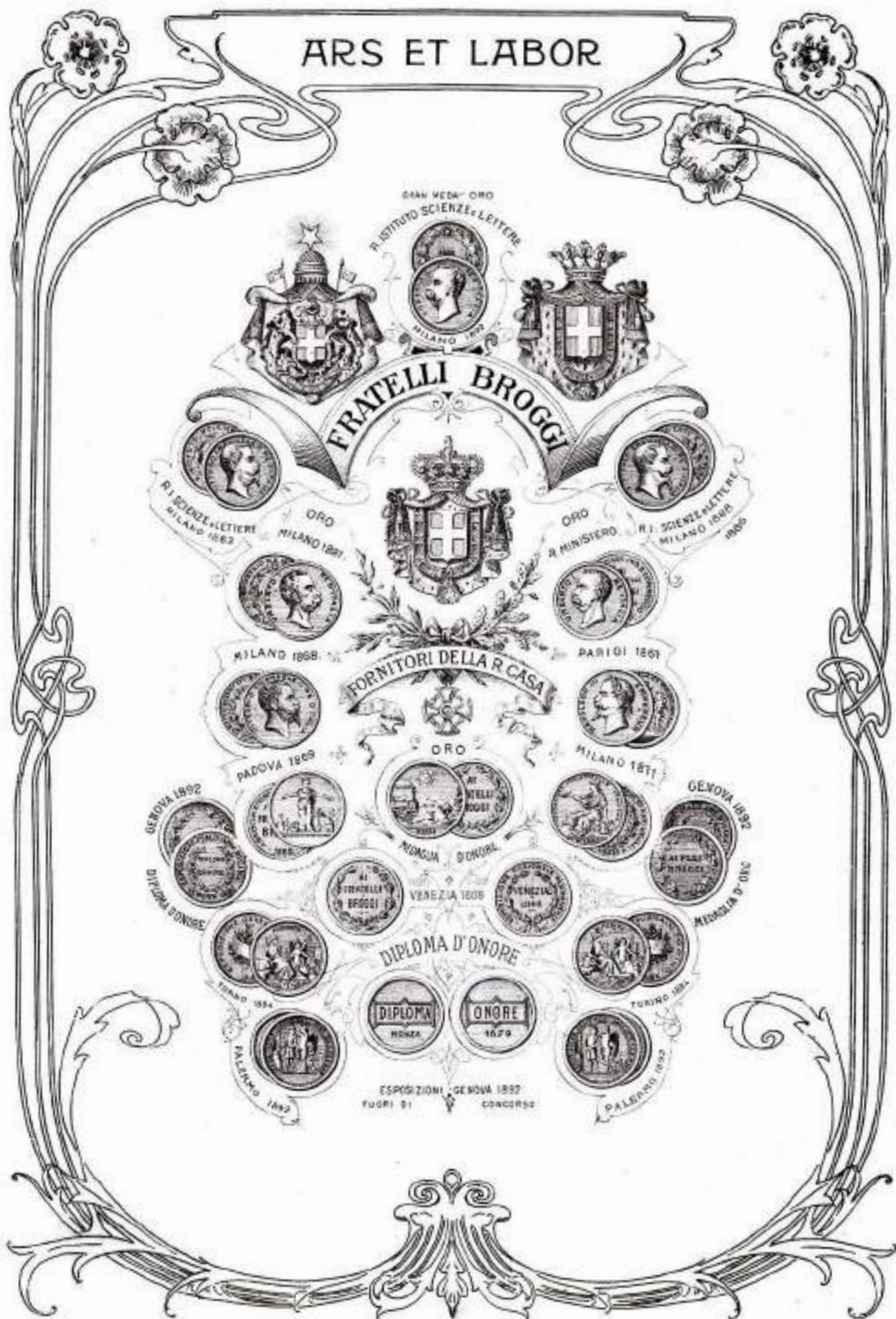

Storia

1818 Gaetano Broggi, giovane intraprendente e pieno di sogni, apre a Milano una piccola bottega di argenteria artigianale e si dedica alla produzione di oggetti per la tavola e oggetti sacri. Ogni oggetto è lavorato a mano, pensato e realizzato dalle mani esperte di Gaetano Broggi e dei suoi garzoni.

1841 Grazie alla qualità delle lavorazioni, negli anni la bottega di Broggi aumenta costantemente la propria clientela arrivando a servire le case reali e non solo. Dallo storico casato milanese degli Sforza agli Asburgo della vicina Austria, fino alla Curia Milanese.

Commesse importanti per un prodotto che non è solo un complemento della tavola e che si pone già come vero e proprio status symbol.

1866 Prodotti di prestigio, una qualità che si fa riconoscere e la richiesta in continua ascesa spingono Broggi a trasferirsi in una sede in grado di consentire una produzione su scala più ampia. Dalla bottega degli anni '20, il sogno di Gaetano Broggi acquista forma e solidità fino a divenire ciò che è oggi: un'azienda vera e propria.

1920 Tra gli ambienti d'élite dell'epoca le voci corrono e Broggi diventa il fornitore ufficiale di lussuose navi da crociera quali l'Andrea Doria, la Rex e la Michelangelo, oltre a rifornire i famosi hotel della Costa Azzurra. Il mondo riconosce sempre di più la qualità e il prestigio di un marchio che sta facendo storia.

1960 Il boom economico degli anni '60 e la diffusa condizione di benessere portano le collezioni Broggi sulle tavole più raffinate d'Italia. Il mercato in costante crescita fa di Broggi una delle aziende leader nel settore della posateria di alta qualità.

1993 Broggi entra a far parte del gruppo Abert S.p.A. Si tratta di una scelta strategica che apre i confini a un mercato sempre più esteso.

2000 Alla fine degli anni Novanta, Broggi avvia un ambizioso processo di internazionalizzazione, portando il marchio oltre

i confini nazionali con l'obiettivo di affermarsi come punto di riferimento nel settore alberghiero e retail.

Questo processo ha permesso a Broggi di diventare un marchio riconosciuto a livello globale, con una presenza consolidata in prestigiosi hotel, catene alberghiere e navi da crociera di lusso. La sede di Broggi viene trasferita a Passirano (BS), dove avviene un processo di ottimizzazione della produzione attraverso importanti investimenti. Comincia un periodo di evoluzione e innovazione stilistica dei prodotti: le linee classiche e storiche vengono affiancate a modelli dai tratti contemporanei, nei quali è sempre riconoscibile il DNA di Broggi, naturale eredità del passato fatto di maestria artigianale e sapiente tecnica.

2018 Nel 2018 Broggi celebra 200 anni di storia, tradizione e innovazione, confermandosi leader in Italia e simbolo dell'italianità nel mondo. Nello stesso anno, l'introduzione del Warehouse Management System ottimizza i flussi logistici, dalla ricezione al tracciamento dell'inventario, consolidando l'efficienza e la qualità che contraddistinguono il marchio.

2022 Viene aperta la sede di Miami (USA), nata per consolidare la presenza del marchio nel mercato americano e rafforzare ulteriormente l'internazionalizzazione di Broggi.

2024 Continua il processo di informatizzazione. Dopo l'introduzione del WMS viene inserito anche il MES- Manufacturing Execution System allo scopo di monitorare, tracciare e ottimizzare il processo di produzione, dalle materie prime ai prodotti finiti.





The Broggi 1818 brand

Broggi 1818 represents a solid industrial reality, part of the historical Abert company since 1993, together with the brand of the same name. A leader in Italy and internationally, Abert excels in the production of cutlery, tableware, buffets, professional Ho.Re.Ca. products and table and kitchen accessories. Under the leadership of the Bertoli family, generation after generation, the company has matured a growing sensitivity towards the evolutions of the market, investing in new technologies, without ever losing the distinctive traits of the corporate style.

Also thanks to this union, Broggi 1818 preserves its artisanal tradition and unmistakable style, while benefiting from the experience and resources of the group, with a particular focus on hospitality, understood as high-end supply for top-level hotels and fine dining establishments. Nowadays the two brands, each with its own distinctive identity, respond in a punctual and complete manner to a wide range of needs in the fields of cutlery, tableware, buffets and table accessories, addressing the Ho.re.ca. and Retail channels.

About us

Since 1818, Broggi has been telling a timeless story of prestige, creating cutlery and tableware in stainless steel and alpaca, buffets, trolleys, and table accessories that revive and reinterpret the exclusive style of the most refined dining settings, especially in high-end hospitality contexts.

The heritage of the master silversmiths of yesteryear is encapsulated in every Broggi 1818 product: a skilful blend of passion, attention to detail and perfection of form capable of creating impeccable mise en place for top-level restaurants and hotels.

A historic brand with a long tradition of craftsmanship, while respecting the original guidelines, Broggi does not remain anchored in the memory of past glories and believes in the importance of continuous and dynamic evolution.

Alongside the decorations and reliefs of the historical collections that have left their mark on the international hotel tradition, today Broggi opens up to the future. From a look at new trends to search for contemporary materials, from the challenge of bringing the designs of cutlery of yesteryear to modern minimalist tables, to the study of new collections destined to create new classics.

Our strength

Tailor-made consultancy: Broggi puts the customer at the center of the decision-making process, offering not just a product, but a personalized consulting service. It is not just a simple sale, but a relationship of trust where the company is constantly present to listen to customers' demands, understand what they really need and guide them in choosing the most suitable solution.

Innovation and wide assortment: Always attentive to the dynamics of the global market, Broggi stands out for its wide assortment of products, often born from valuable collaborations with international partners. Thanks to a network of qualified suppliers, Broggi can count on innovative materials and specialist knowledge that ensure high production standards. Made in Italy experience and distinctive know-how passed on to partners guarantee that each product respects the criteria of excellence and the tradition of quality that has always characterized Broggi, making innovation an integral part of the company process.

Customisation: Broggi offers a wide range of services to meet the specific needs of each customer, through the creation of exclusive products with an attentive and dedicated service: from the possibility of customising articles with engravings, punching and relief applications, to the personalized details of the tableware collections, including grips, borders, handles and spouts. Moreover, there is the possibility of creating unique decorations on porcelain and glasses, with creative solutions that enrich every service with a touch of exclusive elegance. Broggi also allows the realisation of made-to-measure products starting from the customer's specific needs, with the possibility of choosing between different finishes and substantial modifications. Finally, for historical pieces in nickel silver, Broggi offers a restoration service that gives new life to the objects, restoring their charm and keeping their value intact.

Design: From the timeless charm of the most classic lines to the minimalist features of today's tables, from the decorations that evoke past splendour to the smooth surfaces of contemporary settings. Broggi's Italian design preserves the memory of the past but always with an eye on the future.

Tradition, craftsmanship and attention to detail: Broggi combines the craftsmanship of traditional silversmiths with a continuous evolution of design, renewing the historical value of the brand in the present. The collection of evolved classics fits perfectly into the modern contexts of restaurants and boutique hotels, keeping the essence of tradition alive. The company still retains the attention to detail that has made Broggi a benchmark for customising the most prestigious tables of the past.

History

1818 Gaetano Broggi, a young and enterprising man full of dreams, opened a small artisanal silver workshop in Milan and dedicated himself to the production of tableware and sacred objects. Each piece was handcrafted, conceived and created by the expert hands of Gaetano Broggi and his apprentices.

1841 Thanks to the quality of his craftsmanship, over the years Broggi's workshop steadily increased its clientele, eventually serving royal households and beyond. From the historic Milanese House of Sforza to the Habsburgs of nearby Austria, all the way to the Milanese Curia. Prestigious commissions for a product that was not merely a table accessory but already a true status symbol.

1866 Prestigious products, a distinctive quality and steadily growing demand pushed Broggi to move to a new location capable of supporting large-scale production. From the small workshop of the 1820s, Gaetano Broggi's dream took shape and solidity, eventually becoming what it is today: a real company.

1920 Rumors were spreading among the elite circles of the time and Broggi became the official supplier for luxurious cruise ships such as the Andrea Doria, the Rex and the Michelangelo, as well as for the famous hotels of the French Riviera. The world increasingly recognized the quality and prestige of a brand that was making history.

1960 The economic boom of the 1960s and the widespread prosperity brought Broggi collections to the finest tables in Italy. The constantly growing market made Broggi one of the leading companies in the high-quality cutlery sector.

1993 Broggi became part of the Abert S.p.A. group. This strategic choice opened the door to an increasingly broad market.

2000 At the end of the 1990s, Broggi 1818 launched an ambitious internationalization process, taking the brand beyond national borders, with the goal of becoming a point of reference in the hospitality and retail sectors. This strategy enabled Broggi 1818 to become a globally recognized brand, with a solid presence in prestigious hotels, international hotel chains and luxury cruise ships.

The company headquarters was relocated to Passirano (in the province of Brescia), where significant investments led to an optimized production process.

A new phase of stylistic evolution and innovation began; classic and historical lines were joined by more contemporary designs, in which Broggi's dna - rooted in artisanal mastery and refined technique - remains unmistakably present.

2018 In 2018 Broggi 1818 celebrates 200 years of history, tradition and innovation, confirming its leadership in Italy and symbol of Italianness in the world. In the same year, the introduction of the Warehouse Management System optimizes logistics flows, from reception to inventory tracking, consolidating the efficiency and quality that distinguish the brand.

2022 The Miami (USA) office is opened, established to strengthen the brand's presence in the American market and further reinforce Broggi's international expansion.

2024 The computerization process continues. After the introduction of the WMS, it is launched the MES- Manufacturing Execution System in order to monitor, track and optimize the production process, from raw materials to finished products. In addition to CATIA, Solidworks, 3D drawing and design software, is also introduced.

All steel products manufactured by Broggi 1818 are made of AISI 304 (18/10 stainless steel), an austenitic chromium-nickel alloy. Stainless steel derives its name from its ability to resist corrosion far more than any other steel. All knives by Broggi 1818 are made of AISI 420, a martensitic steel used for manufacturing solid-handle knives and the blades of hollow-handle knives. The advantage is its remarkable hardness obtained after suitable hardening treatments. This guarantees that knife blades have a better grip of the cutting edge and enhanced cutting capacity.

Tous les produits en acier réalisés par Broggi 1818 sont en AISI 304 (acier inox 18/10), un alliage austénitique contenant chrome et nickel. L'acier inoxydable tire son nom de la capacité de résister à la corrosion beaucoup plus que n'importe quel acier. Tous les couteaux réalisés par Broggi 1818 sont en AISI 420, acier martensitique qui est utilisé pour la fabrication de couteaux monobloc et pour les lames des couteaux à manche creux. Sa qualité est sa dureté considérable qu'il acquiert après les traitements opportuns de trempe. Ceci garantit aux lames des couteaux une plus grande tenue du fil tranchant et une majeure capacité de coupe.

Todos los productos de acero realizados por Broggi 1818 son de AISI 304 (acero inox 18/10), una aleación austenítica que contiene cromo y níquel. El acero inoxidable toma este nombre por la capacidad de resistir a la corrosión mucho más que cualquier otro acero. Todos los cuchillos realizados por Broggi 1818 están elaborados con AISI 420, acero martensítico que es utilizado para la fabricación de cuchillos monobloque y para las hojas de cuchillos de mango cóncavo. El valor está en la notable dureza que adquiere después de los oportunos tratamientos de temple. Ello garantiza a las hojas de los cuchillos una mayor duración del filo cortante y una mayor capacidad de corte.

Alle von Broggi 1818 realisierten Stahlprodukte sind aus AISI 304 (rostfreier 18/10 Stahl) und bestehen aus einer Austenit Legierung, die Chrom und Nickel enthält. Der rostfreie oder sogenannte Inox Stahl verdankt seinen Namen der außergewöhnlichen Korrosionsfestigkeit, die höher als bei jedem anderen Stahl ist. Alle Broggi 1818 Messer sind aus AISI 420, Martensit Stahl, der bei der Herstellung von Messern aus einem Block und Klingen von Messern mit Hohlgriff eingesetzt wird. Der Werkstoff verdankt seine besondere Härte entsprechenden Härtingsprozessen während der Verarbeitung. Dadurch bleibt die Klinge länger scharf und das Messer schneidet besser und präziser.

Posateria

Acciaio - 18/10

Cutlery - St. Steel
Couverts - Acier Inox
Cubiertos - Acero Inox
Besteck - Edelstahl

Tutti i prodotti in acciaio realizzati da Broggi 1818 sono in AISI 304 (acciaio inox 18/10), lega austenitica contenente cromo e nichel. L'acciaio inossidabile deriva il suo nome dalla capacità di resistere alla corrosione molto più di qualunque altro acciaio. Tutti i coltelli realizzati da Broggi 1818 sono in AISI 420, acciaio martensitico che viene utilizzato per la fabbricazione di coltelli monoblocco e per le lame dei coltelli a manico cavo. Il pregio è la sua notevole durezza che acquista dopo gli opportuni trattamenti di tempra. Ciò garantisce alle lame dei coltelli una maggiore tenuta del filo tagliente ed una maggior capacità di taglio.

Cutlery manufacturing process

Shearing (1) is the first step in the process of manufacturing forks and spoons. Rolling (2) is used to reduce the bowl thickness compared to that of the handle, and the next step is trimming (3) to give the shape of a bowl or prongs to the laminated implement. The final step is coining (4) during which the implement is shaped and ornamentation stamped. To make forged solid-handle knives the process begins by shearing a bar into a blank (1) that is then hot coined (2) so as to give it some initial shape. Afterwards the handle is sheared (3) and the blade is stretched (4). Then, the blade is sheared (5) so that it takes its final shape. Now blade serration (6) needs to be defined and the knife has to be polished as usual. The first step to make forged hollow-handle knives is shearing the shells (1). The two half-shells that will form the hollow handle are cold-coined (2) to obtain the convexity and stamp the decoration; afterwards the shells are coupled and welded (3). And that is how the knife handle is ready. Finally and by using a self-locking compound the blade, made applying the same techniques used to make forged solid-handle knives, is coupled and welded to the handle (4).

Cycle de production couverts

Le cycle de production de fourchettes et cuillères commence par l'opération de découpage (1). Afin de diminuer l'épaisseur du cuilleron par rapport au manche, on procède ensuite au laminage (2), et on continue avec l'ébarbage (3), pour donner la forme du cuilleron ou des dents au couvert laminé. Finalement, on passe au calibrage (4), au cours duquel on donne la forme et les décorations nécessaires. Pour l'usinage des couteaux monobloc forgés on commence par le découpage du rond en un tronçon (1), qui est successivement calibré à chaud (2), de façon à lui donner une première forme. On continue avec le découpage du manche (3) et avec l'étirement de la lame (4); par la suite, on réalise le découpage de la lame (5), de façon à lui donner sa forme réelle. À ce moment-là, il ne reste plus qu'à définir la dentelure sur la lame (6) et achever le couteau avec les normales opérations de nettoyage. Les phases d'usinage des couteaux à manche creux forgés commencent par le découpage des plaquettes (1). Les deux plaquettes qui constitueront le manche creux sont calibrées à froid (2), pour leur donner la convexité et les décorations; ensuite, elles sont accouplées et soudées (3): voici le manche du couteau. Finalement, à travers un composant autobloquant, la lame, produite avec les mêmes techniques que les couteaux monobloc forgés, est assemblée et soudée au manche (4).

Ciclo de producción cubiertos

El ciclo de producción de tenedores y cucharas inicia con la operación de tronzado (1). Para reducir el grosor de la taza con respecto al mango, se procede luego al laminado (2), y se prosigue con el recorte (3), para dar la forma de la taza y de los dientes al cubierto laminado. Finalmente se pasa a la acuñación (4), en el curso de la cual se confiere la forma y las decoraciones necesarias. Para la elaboración de los cuchillos monoblock forjados se comienza con el tronzado de la varilla para obtener un fragmento (1), que sucesivamente es acuñado en caliente (2), para conferirle una forma inicial. Se prosigue con el tronzado del mango (3) y con el alargamiento de la hoja (4); a continuación se lleva a cabo el tronzado de la hoja (5), para conferirle la forma real. A estas alturas queda por definir el dentado de la hoja (6) y acabar el cuchillo con las normales operaciones de pulido. Las fases de elaboración de los cuchillos de mango cóncavo forjado comienzan con el tronzado de las valvas (1). Las dos valvas que constituyen el mango cóncavo son acuñadas en frío (2), para conferirles la convexidad y las decoraciones, y luego son acopladas y soldadas (3): he aquí el mango del cuchillo. Finalmente, a través de un compuesto auto-bloqueador, la hoja es ensamblada y soldada al mango (4), producida con las mismas técnicas de los cuchillos monoblock forjados.

Produktionszyklus besteck

Der Produktionszyklus von Gabeln und Löffeln beginnt mit dem Schnittvorgang (1). Die Stärke der Löffelschale im Verhältnis zum Griff wird durch Walzen (2) verkleinert, dann erfolgt das Beschneiden (3), zur Formgestaltung der Löffelschale bzw. der Zinken der Gabel. Bei der anschließenden Prägung (4) werden den Besteckelementen Form und Dekordetails verliehen. Bei der Fertigung von geschmiedeten Messern aus einem Block beginnt man mit dem Schnitt des Rundteils in ein Bruchstück (1), das dann durch Warmprägung (2) eine erste Form erhält. Darauf folgen der Schnitt des Griffs (3) und die Verlängerung der Klinge (4); der anschließende Zuschnitt der Klinge (5) verleiht dieser die tatsächliche bzw. endgültige Form. In abschließenden Arbeitsschritten wird die Sägegestaltung an der Klinge (6) durchgeführt und das Messer mit den üblichen Reinigungsabläufen fertiggestellt. Die Bearbeitung von geschmiedeten Messern mit Hohlgriff beginnt mit dem Schnitt der Schalen (1). Die beiden Schalen, aus denen später der Hohlgriff besteht, erhalten durch Kaltprägung (2) die passende Höhlung und Dekorgestaltung und werden dann zusammengesetzt und gelötet (3): damit ist der Messergriff erstellt. Mit einem Selbstklebergemisch wird die Klinge, die mit der gleichen Arbeitstechnik von geschmiedeten Messern aus einem Block entstanden ist, am Messer angebracht und angelötet.

Broggi

Fasi di lavorazione

Il ciclo di produzione di forchette e cucchiai inizia con l'operazione di tranciatura (1). Per diminuire lo spessore della tazza rispetto al manico, si procede poi con la laminazione (2), e si prosegue con la rifilatura (3), per dare la forma della tazza o dei rebbi alla posata laminata. Infine si passa alla coniazione (4), nel corso della quale vengono dati la forma e i decori necessari. Per la lavorazione dei coltelli monoblocco forgiati si parte con la tranciatura del tondino in uno spezzone (1), che viene successivamente coniato a caldo (2), in modo da conferirgli una prima forma. Si prosegue con la tranciatura del manico (3) e con l'allungamento della lama (4); in seguito viene effettuata la tranciatura della lama (5), in modo da darle la forma reale. A questo punto rimane da definire la segheatura sulla lama (6) e rifinire il coltello con le normali operazioni di pulitura. Le fasi di lavorazione dei coltelli a manico cavo forgiati parte con la tranciatura delle valve (1). Le due valve che costituiranno il manico cavo vengono coniate a freddo (2), per dare loro la convessità e i decori, e poi vengono accoppiate e saldate (3): ecco il manico del coltello. Infine, attraverso un composto autobloccante, viene assemblata e saldata al manico la lama (4), prodotta con le stesse tecniche dei coltelli monoblocco forgiati.

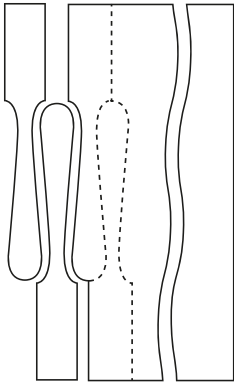

1
Tranciatura
Blank cutting

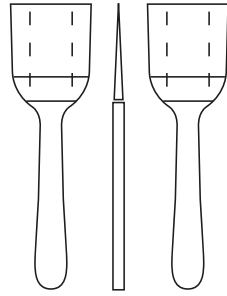

2
Laminazione
Rolling operation

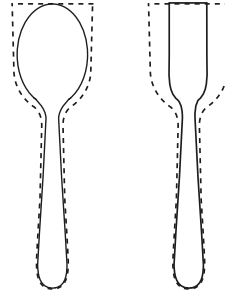

3
Rifilatura
Overall cutting on outside blank

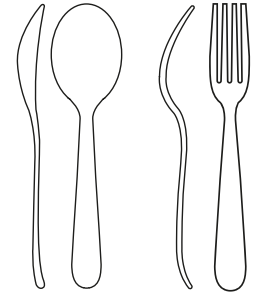

4
Coniatura
Pressing operation

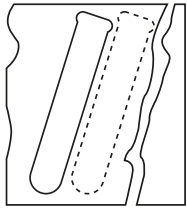

5
Tranciatura
Blank cutting



6
Coniatura manico
Handle pressing



7
Saldatura gocce
Soldering of shells

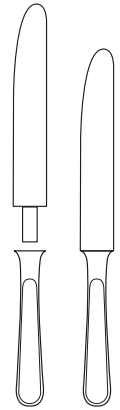

8
**Assemblaggio e saldatura
lama manico cavo**
Hollow handle knife
assembling and soldering



9
Tranciatura spezzone
Rod cutting



10
Coniatura a caldo
Forging

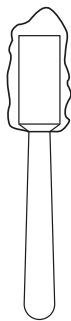

11
Tranciatura manico
Blank cutting of the blade

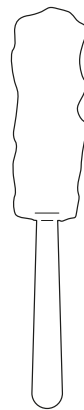

12
Laminazione
Rolling of the blade

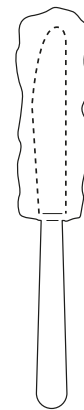

13
Ritanciatura lama
Second blank
cutting of the blade

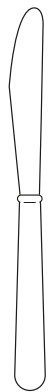

14
Seghettatura e finitura
Blade grinding
and finishing



Contemporary

Acciaio - 18/10 St. Steel

The collection was born from an idea by the Maestro, combining design and function with a new element: each piece of cutlery has a specific use. The risotto spoon in order to taste, at last, the sauce as well. The spaghetti spoon and fork, a modern and fashionable couple. The tongs that allow to savor hors d'oeuvres and fried food without piercing them. The steak set with the famous two-prong fork and the rigorously scalpel-shaped steak knife, in order not to fray the meat. The ambide x trous fish knife, created to meet with the needs of a left-handed person and divide the fish with just one touch. The philosophy that inspired the design of the series is the one of the chopstick. Handles and knobs are actually references to the famous Japanese object, while bowl and prongs maintain, in their lines, all the rich gastronomic Italian tradition.

La collection naît d'une idée du Maestro qui conjugue design et fonctionnalité avec un élément neuf: chaque couvert a une utilisation spécifique. La cuillère risotto pour goûter enfin même le condiment. La cuillère et la fourchette spaghetti, couple moderne et actuel. La pince personnelle qui consent de savourer des hors-d'œuvre et des fritures sans les embrocher. Le couple viande avec la fameuse fourchette à deux dents et le couteau beefsteak rigoureusement en «bistouri», pour ne pas effiloche la viande. Le couteau à poisson ambide x tre, conçu pour venir à la rencontre de l'e x igence d'un gaucher et séparer le poisson d'un seul geste. La philosophie qui a inspiré le design de la série est celle du chopstick. Les manches et les queues sont en effet des citations du fameux objet japonais, tandis que les tasses et les dents conservent dans leur ligne toute la savante tradition gastronomique italienne.

Nace de una idea del Maestro que conjuga design y funcionalidad con un elemento nuevo: cada cubierto tiene un empleo específico. La cuchara risotto para saborear finalmente también el condimento. La cuchara y el tenedor espaguetis, pareja moderna y actual. Las pinzas personales que permiten saborear entrantes y frituras sin ensartarlos. La pareja carne con el famoso tenedor de dos dientes y el cuchillo bistec rigurosamente tipo "bisturí", para no deshilar la carne. El cuchillo para pescado ambidiestro, concebido para salir al encuentro de las e x igencias de un zurdo y separar con un solo toque el pescado. La filosofía que ha inspirado el design de la serie es la de un chopstick. Los mangos y espigas son de hecho citas del famoso objeto japonés, mientras que las tazas y los dientes conservan en sus líneas toda la sabia tradición gastronómica italiana.

Die Kollektion geht auf eine Idee des Meisters zurück, die Design und Zweckmäßigkeit mit einem völlig neuen Element vereint: jedes Besteckteil ist für einen ganz besonderen Verwendungszweck bestimmt. Der Risottolöffel erleichtert das Servieren in Portionen und das gleichmäßige Verteilen von Einlagen/Saucen, die den Risotto anreichern. Der Löffel wird im raffinierten Set mit der Spaghettigabel präsentiert. Die praktische Greifzange ist für das bequeme Verkosten von Vorspeisen und frittierten Appetizern gedacht. Das Fleischset besteht aus der üblichen langen Gabel mit zwei Zinken und dem klassischen, wie ein Seziermesser gestaltetem Steakmesser zum perfekten Tranchieren des Filets. Das Fischmesser ist auch für Linkshänder gedacht und ermöglicht das einfache und mühelose Zerteilen des Fisches. Die Philosophie, die dieses Design inspiriert, steht im 'Chopstick' Zeichen: Griffe und Stiele verweisen auf die berühmte japanische Formgestaltung, während die Hohlfächen und Zinken in ihren Linien voll und ganz der reichen italienischen Tradition verbunden sind.

Gualtiero

Marchesi

Oriental inspirations for unusual tools

Nasce da un'idea del Maestro che coniuga design e funzionalità con un elemento nuovo: ogni posata ha un utilizzo specifico. Il cucchiaino risotto per gustare finalmente anche il condimento. Il cucchiaino e la forchetta spaghetti, coppia moderna e attuale. La pinza personale che consente di assaporare antipasti e fritti senza infilarli. La coppia carne con la famosa forchetta a due rebbi ed il coltello bistecca rigorosamente a "bisturí", per non sfilacciare la carne. Il coltello pesce ambodestro, ideato per venire incontro all'esigenza di un mancino e separare con un solo tocco il pesce. La filosofia che ha ispirato il design della serie è quella di un chopstick. Manici e codoli sono infatti citazioni del famoso oggetto giapponese, mentre tazze e rebbi conservano nelle loro linee tutta la sapiente tradizione gastronomica italiana.



Marchesi

acciaio inox 18/10
stainless steel 18/10
cod. 117.05.

acciaio argentato
electro-plated stainless steel (EPSS)
cod. 117.07.



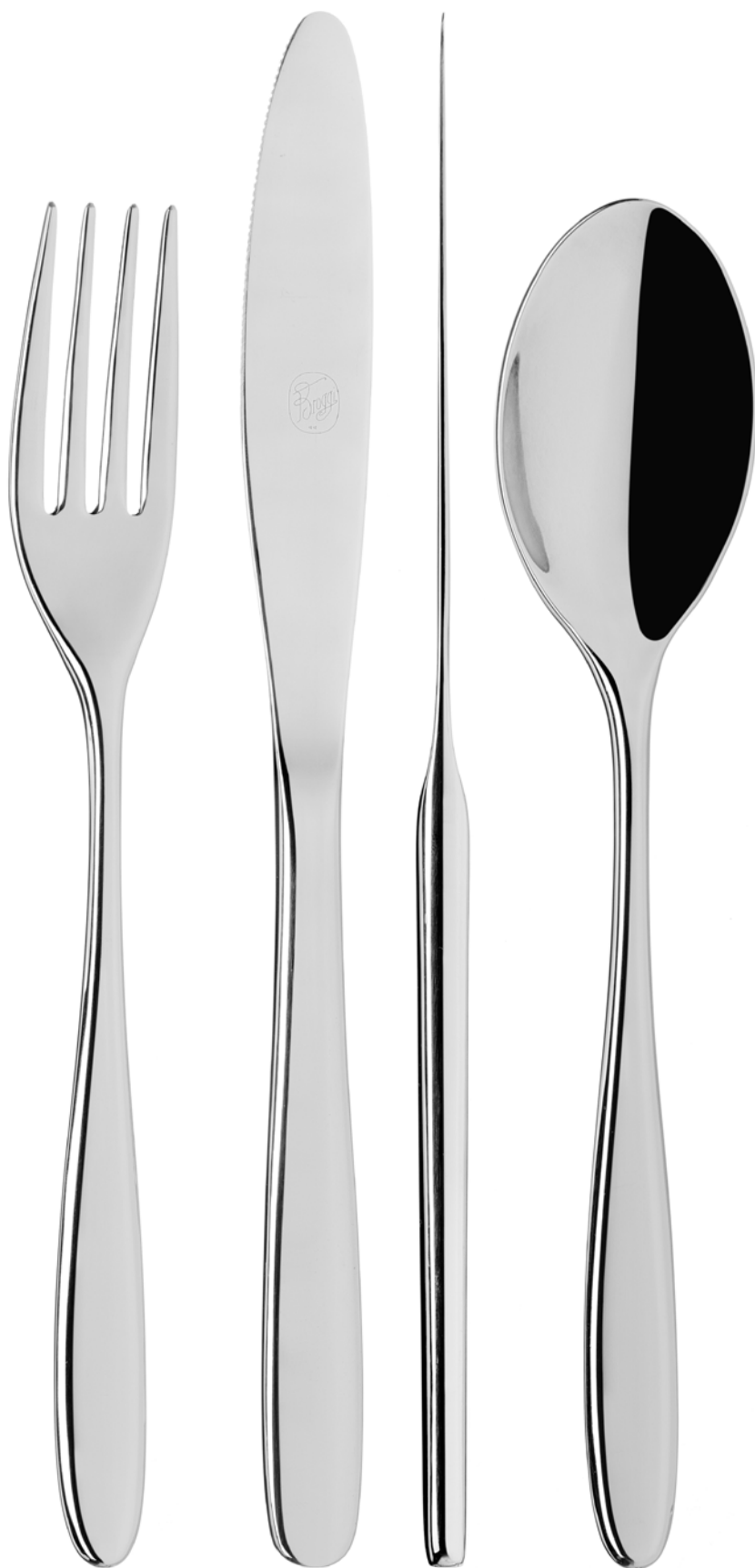

Ovalino

acciaio inox 18/10
stainless steel 18/10
cod. 130.05.

acciaio argentato
electro-plated stainless steel (EPSS)
cod. 130.07.





Materia

acciaio inox 18/10
stainless steel 18/10
cod. 176.05.

acciaio argentato
electro-plated stainless steel (EPSS)
cod. 176.07.

Posate



Duecento

acciaio inox 18/10
stainless steel 18/10
cod. 200.05.

acciaio argentato
electro-plated stainless steel (EPSS)
cod. 200.07.

DESIGN: OSVALDO FERRARIS



Impulso

acciaio inox 18/10
stainless steel 18/10
cod. 182.05.

acciaio argentato
electro-plated stainless steel (EPSS)
cod. 182.07.

Posate



Zeta

acciaio inox 18/10
stainless steel 18/10
cod. 116.05.

acciaio argentato
electro-plated stainless steel (EPSS)
cod. 116.07.



Canto

acciaio inox 18/10
stainless steel 18/10
cod. 183.05.

acciaio argentato
electro-plated stainless steel (EPSS)
cod. 183.07.





Stiletto

acciaio inox 18/10
stainless steel 18/10
cod. 113.05.

acciaio argentato
electro-plated stainless steel (EPSS)
cod. 113.07.

Posate



Luce

acciaio inox 18/10
stainless steel 18/10
cod. 181.05.

acciaio argentato
electro-plated stainless steel (EPSS)
cod. 181.07.



Sedona

acciaio inox 18/10
stainless steel 18/10
cod. 111.05.

acciaio argentato
electro-plated stainless steel (EPSS)
cod. 111.07.

Posate



City

acciaio inox 18/10
stainless steel 18/10
cod. 122.05.

acciaio argentato
electro-plated stainless steel (EPSS)
cod. 122.07.



Rail

acciaio inox 18/10
stainless steel 18/10
cod. 114.05.

acciaio argentato
electro-plated stainless steel (EPSS)
cod. 114.07.

Posate



Gaia

acciaio inox 18/10
stainless steel 18/10
cod. 115.05.

acciaio argentato
electro-plated stainless steel (EPSS)
cod. 115.07.



Piano

*acciaio inox 18/10
stainless steel 18/10
cod. 109.05.*

*Acciaio argentato
electro-plated stainless steel (EPSS)
cod. 109.07.*

Posate



Sky

acciaio inox 18/10
stainless steel 18/10
cod. CE5.BR.05

Acciaio argentato
electro-plated stainless steel (EPSS)
cod. CE5.BR.07



Dakar

acciaio inox 18/10
stainless steel 18/10
cod. 194.05.

cod. 194.05.04.

● *acacia - acacia*

cod. 194.05.09.

● *wengé - wengè*





Kyoto

*Acciaio inox 18/10 - Stainless Steel 18/10
Manico in POM - POM handle
Finitura satinata - Satin finish
PVD GOLD METAL*

cod. 192.41.14
● nero - black

Set 2 pz - cod. 192.41.14.082
● nero - black



Kyoto

Acciaio inox 18/10 - Stainless Steel 18/10
Manico in POM - POM handle
Finitura satinata - Satin finish

cod. 192.05.14

● nero - black

Set 2 pz - cod. 192.05.14.082

● nero - black



Kyoto

Acciaio inox 18/10 - Stainless Steel 18/10

Manico in POM - POM handle

Finitura satinata - Satin finish

cod. 192.05.16

○ bianco - white

Set 2 pz - cod. 192.05.16.082

○ bianco - white





Classic
Acciaio - 18/10 St. Steel





Foscari

acciaio inox 18/10
stainless steel 18/10
cod. 134.05.

acciaio argentato
electro-plated stainless steel (EPSS)
cod. 134.07.



Metropolitan

acciaio inox 18/10
stainless steel 18/10
cod. 120.05.

acciaio argentato
electro-plated stainless steel (EPSS)
cod. 120.07.



Serbelloni

acciaio inox 18/10
stainless steel 18/10
cod. 010.05.

acciaio argentato
electro-plated stainless steel (EPSS)
cod. 010.07.





Cortese

*acciaio inox 18/10
stainless steel 18/10
cod. 160.05.*

*Acciaio argentato
electro-plated stainless steel (EPSS)
cod. 160.07.*

Posate



Medici

acciaio inox 18/10
stainless steel 18/10
cod. 110.05.

acciaio argentato
electro-plated stainless steel (EPSS)
cod. 110.07.





Rubans

acciaio inox 18/10
stainless steel 18/10
cod. 125.05.

acciaio argentato
electro-plated stainless steel (EPSS)
cod. 125.07.



900

acciaio inox 18/10
stainless steel 18/10
cod. CP 2CS.

acciaio argentato
electro-plated stainless steel (EPSS)
cod. CP 2CSA.

Posate



Rialto

acciaio inox 18/10
stainless steel 18/10
cod. 158.05.

acciaio argentato
electro-plated stainless steel (EPSS)
cod. 158.07.







Decò

acciaio inox 18/10
stainless steel 18/10
cod. 126.05.

acciaio argentato
electro-plated stainless steel (EPSS)
cod. 126.07.



Baguette

acciaio inox 18/10
stainless steel 18/10
cod. 164.05.

acciaio argentato
electro-plated stainless steel (EPSS)
cod. 164.07.



Royal

acciaio inox 18/10
stainless steel 18/10
cod. 143.05.

acciaio argentato
electro-plated stainless steel (EPSS)
cod. 143.07.

Posate



Palio

acciaio inox 18/10
stainless steel 18/10
cod. 165.05.

acciaio argentato
electro-plated stainless steel (EPSS)
cod. 165.07.



Tea Time

acciaio inox 18/10
stainless steel 18/10

Forchetta pasticceria

Tea Time pastry fork
Fourchette à pâtisserie
Tenedor de pastelería
Kuchengabel

	Cm	In
143 05 00 102	15	6

Coltello pasticceria

Tea Time pastry knife
Couteau à pâtisserie
Cuchillo de pastelería
Kuchmesser

	Cm	In
143 05 00 103	18,3	7

Cucchiaio pasticceria

Tea Time pastry spoon
Cuillère à pâtisserie
Cuchara de pastelería
Kuchenlöffel

	Cm	In
143 05 00 101	15	6



LUNGHEZZA POSATE (MM.)





























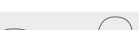
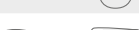
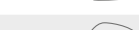

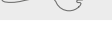

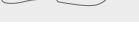





CUTLERY LENGTH (MM.)









acciaio inox 18/10 - stainless steel 18/10

acciaio argentato - electro-plated stainless steel (EPSS)

TIPOLOGIA

Spessori

							
			COD. 117 05 .. COD. 117 07 ..	COD. 130 05 .. COD. 130 07 ..	COD. 176 05 .. COD. 176 07 ..	COD. 200 05 .. COD. 200 07 ..	COD. 182 05 .. COD. 182 07 ..
			Mod. 117 GUALTIERO MARCHESI	Mod. 130 OVALINO	Mod. 176 MATERIA	Mod. 200 DUECENTO	Mod. 182 IMPULSO
			8 mm	5 mm	3,5 mm	5 mm	5,5 mm
001	Cucchiaino tavola <i>Table spoon</i>		216	209	208	210	207
002	Forchetta tavola / Carne** <i>Table fork</i>		215**	208	208	210	207
003	Cucchiaino brodo <i>Soup spoon</i>		178	176	176	183	177
005	Coltello tavola monoblocco <i>Table knife, solid handle</i>		236	235	240	245	235
009	Coltello tavola manico cavo <i>Table knife, hollow handle</i>					245	
01009	Coltello tavola m. cavo lama a spatola <i>Table knife, hollow handle with spatula-shaped blade</i>						
011	Cucchiaino frutta / Risotto** <i>Dessert spoon</i>		200**	187	185	185	192
012	Forchetta frutta <i>Dessert fork</i>		200	188	185	184	192
015	Coltello frutta monoblocco <i>Dessert knife, solid handle</i>		220	212	216	220	218
019	Coltello frutta manico cavo <i>Dessert knife, hollow handle</i>					220	
01019	Coltello frutta m. cavo lama a spatola <i>Dessert knife, hollow handle with spatula-shaped blade</i>						
021	Cucchiaino the <i>Tea spoon</i>		140	146	141	148	145
022	Cucchiaino moka <i>Moka spoon</i>		108	115	111	115	108
023	Cucchiaino zucchero / Molla Individuale** <i>Sugar spoon</i>		225**				
025	Mestolo 130 ml - 4 oz <i>Soup ladle</i>						305
026	Forchetta servire <i>Serving fork</i>					242	245
027	Cucchiaino servire <i>Serving spoon</i>					241	245
028	Cucchiaino servire insalata <i>Salad serving spoon</i>						
029	Forchetta servire insalata <i>Salad serving fork</i>						
031	Forchetta pesce <i>Fish fork</i>		215	188	181	185	185
032	Coltello pesce <i>Fish knife</i>		221	205	195	196	198
033	Forchetta servire pesce <i>Fish serving fork</i>						
034	Coltello servire pesce <i>Fish serving knife</i>						
035	Cucchiaino bibita <i>Iced tea spoon</i>						
037	Paletta gelato <i>Ice cream spoon</i>						
038	Forchetta dolce <i>Cake fork</i>		183	150		147	144
039	Pala torta <i>Cake server</i>						245
042	Mestolino salsa 22 ml - 0,75 oz <i>Sauce ladle</i>						165
043	Coltello burro m. cavo <i>Butter knife, hollow handle</i>					174	
053	Coltello burro monoblocco <i>Butter knife, solid handle</i>		170		170		175
055	Coltello carne manico cavo <i>Steak knife, hollow handle</i>					245	
059	Coltello carne monoblocco <i>Steak knife, solid handle</i>		238				225
061	Coltello trinciare <i>Carving knife</i>						
062	Forchetta trinciare <i>Carving fork</i>						
067	Cucchiaino salsa <i>Gourmet spoon</i>		200			185	192
082	Bastoncini <i>Chopsticks</i>						
02002	Forchetta spaghetti <i>Spaghetti fork</i>		215				
080	Cucchiaino Lunch <i>Lunch spoon</i>						

								
COD. 116 05 .. COD. 116 07 ..	COD. 183 05 .. COD. 183 07 ..	COD. 113 05 .. COD. 113 07 ..	COD. 181 05 .. COD. 181 07 ..	COD. 111 05 COD. 111 07	COD. 122 05 .. COD. 122 07 ..	COD. 114 05 .. COD. 114 07 ..	COD. 115 05 .. COD. 115 07 ..	COD. 109 05 .. COD. 109 07 ..
Mod. 116 ZETA	Mod. 183 CANTO	Mod. 113 STILETTO	Mod. 181 LUCE	Mod. 111 SEDONA	Mod. 122 CITY	Mod. 114 RAIL	Mod. 115 GAIA	Mod. 109 PIANO
5 mm	3 mm	5,5 mm	4,5 mm	5,5 mm	4 mm	3 mm	4 mm	3 mm
210	205	210	206	207	196	206	222	209
210	203	205	205	205	199	206	226	210
179	172	179	181	175	173	175		180
240	235	235	225	237	241	235	251	233
					243			
189	185	187	183	190	176	185	202	185
189	185	186	184	193	178	185	203	187
216	211	211	204	218	220	211	230	210
					220			
147	143	146	149	143	133	144	150	136
115	114	115	108	108	104	133	119	110
					120			
300		306	298		307	304	297	
241	237	241	237	242	230	237	248	
241	236	236	242	244	227	237	245	
					227			
					227			
189	195	182	185	184	199	185	201	200
200	206	198	204	204	211	209	227	214
					195			
					131			
157	145	145	155	144	143	146		144
240		257	245	265	240	262	270	
159		158	165	165	160	165	170	
170	175	165	175	172	166	165		177
225			225	230	223			233
189	185	187	183	190	176	185	202	
				160				



LUNGHEZZA POSATE (MM.)













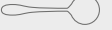











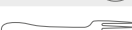
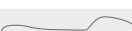



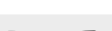







CUTLERY LENGTH (MM.)











acciaio inox 18/10 - stainless steel 18/10

acciaio argentato - electro-plated stainless steel (EPSS)

TIPOLOGIA

Spessori

		COD. CE5BR ..	COD. 194 05 04 .. COD. 194 05 09 ..	COD. 192 05 14 COD. 192 05 16 COD. 192 41 14	COD. 134 05 .. COD. 134 07 ..	COD. 120 05 .. COD. 120 07 ..	
		Mod. CE5BR SKY	Mod. 194 DAKAR ACACIA / WENGE	Mod. 192 KYOTO	Mod. 134 FOSCARI	Mod. 120 METROPOLITAN	
		3,5 mm			4 mm	5 mm	
001	Cucchiaino tavola <i>Table spoon</i>		207	205	211	210	202
002	Forchetta tavola / Carne** <i>Table fork</i>		207	207	211	213	201
003	Cucchiaino brodo <i>Soup spoon</i>					177	179
005	Coltello tavola monoblocco <i>Table knife, solid handle</i>		231		237	243	230
009	Coltello tavola manico cavo <i>Table knife, hollow handle</i>			230			236
01009	Coltello tavola m. cavo lama a spatola <i>Table knife, hollow handle with spatula-shaped blade</i>						
011	Cucchiaino frutta / Risotto** <i>Dessert spoon</i>		186	199	191	189	182
012	Forchetta frutta <i>Dessert fork</i>		186	197	193	192	182
015	Coltello frutta monoblocco <i>Dessert knife, solid handle</i>		209		211	219	207
019	Coltello frutta manico cavo <i>Dessert knife, hollow handle</i>			218			207
01019	Coltello frutta m. cavo lama a spatola <i>Dessert knife, hollow handle with spatula-shaped blade</i>						
021	Cucchiaino the <i>Tea spoon</i>		145	149	148	147	142
022	Cucchiaino moka <i>Moka spoon</i>		114	134	112	111	106
023	Cucchiaino zucchero / Molla Individuale** <i>Sugar spoon</i>						
025	Mestolo 130 ml - 4 oz <i>Soup ladle</i>		306	224			322
026	Forchetta servire <i>Serving fork</i>		237	219			262
027	Cucchiaino servire <i>Serving spoon</i>		234	219			259
028	Cucchiaino servire insalata <i>Salad serving spoon</i>						
029	Forchetta servire insalata <i>Salad serving fork</i>						
031	Forchetta pesce <i>Fish fork</i>					192	201
032	Coltello pesce <i>Fish knife</i>		215			205	217
033	Forchetta servire pesce <i>Fish serving fork</i>						
034	Coltello servire pesce <i>Fish serving knife</i>						
035	Cucchiaino bibita <i>Iced tea spoon</i>						207
037	Paletta gelato <i>Ice cream spoon</i>						
038	Forchetta dolce <i>Cake fork</i>		150	151	149		147
039	Pala torta <i>Cake server</i>		250	244			256
042	Mestolino salsa 22 ml - 0,75 oz <i>Sauce ladle</i>						172
043	Coltello burro m. cavo <i>Butter knife, hollow handle</i>						
053	Coltello burro monoblocco <i>Butter knife, solid handle</i>		175		150	178	170
055	Coltello carne manico cavo <i>Steak knife, hollow handle</i>						222
059	Coltello carne monoblocco <i>Steak knife, solid handle</i>						
061	Coltello trinciare <i>Carving knife</i>						
062	Forchetta trinciare <i>Carving fork</i>						
067	Cucchiaino salsa <i>Gourmet spoon</i>						182
082	Bastoncini <i>Chopsticks</i>				227		
02002	Forchetta spaghetti <i>Spaghetti fork</i>						
080	Cucchiaino Lunch <i>Lunch spoon</i>						

									
COD. 010 05 .. COD. 010 07 ..	COD. 160.05. COD. 160.07.	COD. 110 05 .. COD. 110 07 ..	COD. 125 05 .. COD. 125 07 ..	COD. CP2CS COD. CP2CSA	COD. 158 05 .. COD. 158 07 ..	COD. 126 05 .. COD. 126 07 ..	COD. 164 05 .. COD. 164 07 ..	COD. 143 05 .. COD. 143 07 ..	COD. 165 05 .. COD. 165 07 ..
Mod. 010 SERBELLONI	Mod. 160 CORTESE	Mod. 110 MEDICI	Mod. 125 RUBANS	Mod. CP2 900	Mod. 158 RIALTO	Mod. 126 DECO'	Mod. 164 BAGUETTE	Mod. 143 ROYAL	Mod. 165 PALIO
3 mm		3 mm	3 mm	3 mm	3,5 mm	3 mm	3 mm	3 mm	3 mm
207	206	207	206	205	203	203	204	203	203
205	208	205	208	207	205	203	204	205	204
175	172	175	172	178	178	173	169	173	168
237	247	237	235	234	235	228	247	226	237
239	243	239	242		242	244	243	234	243
							238		
186	185	186	185	185	180	182	178	179	178
187	185	187	187	186	180	182	180	179	178
215	214	215	212	216	212	205	214	205	215
215	219	215	218		219	219	219	216	219
							216		
141	140	141	138	143	143	139	143	143	142
118	118	118	109	106	112	109	112	112	112
296	298	296	310	300	300	308	298	295	292
227	238	227	238	242	240	233	238	240	240
225	236	225	236	237	236	233	236	236	236
225		225							
225		225							
182	180	182	184	184	181	180	204	205	205
202	193	202	209	217	185	200	208	209	209
245		245							230
267		267							250
		208	192	192	206	208	206	193	207
140		140			133		133	133	133
152	145	152	144	149	153	146	153	153	153
242	245	242	245	262	237	242	238	237	237
158	164	158	154		152	150	164	158	147
163	160	163					160		160
171	166	171	171	170	172	196	166	171	166
216	223	216			215		223	217	223
225	212	225					212		212
186		186	185		180	182	178	179	178

Better known as EPNS, it is a precious alloy of copper, zinc and nickel. The high concentration of nickel present in the alloy used by Broggi 1818 improves its mechanical features and endurance. The galvanisation process permits depositing pure silver at 999,99% with high thicknesses and so this alloy can have almost unlimited uses. Due to its nature, EPNS has features and behaviour very similar to solid silver. In fact, specific weight, malleability, thermal conductivity, warm colour, and pleasing aging are all features of a noble metal.

Mieu x connue comme EPNS (Electro Plated Nickel Silver), il s'agit d'un alliage de qualité de cuivre, zinc et nickel. La haute concentration de nickel présent dans l'alliage utilisé par Broggi 1818 en améliore les caractéristiques mécaniques et la résistance. Le procès de galvanisation permet de déposer de l'argent pur à 999,99% avec des épaisseurs élevées qui en consent l'utilisation presque illimitée. Le maillechort, par sa nature, a des caractéristiques et des comportements très semblables à l'argent massif. En effet, poids spécifique, malléabilité, conductibilité thermique, couleur chaude, vieillissement agréable, sont toutes des caractéristiques d'un métal noble.

Mejor conocida como EPNS (Electro Plated Nickel Silver), se trata de una aleación preciada de cobre, zinc y níquel: la elevada concentración de níquel presente en la aleación utilizada por Broggi 1818 mejora sus características mecánicas y la resistencia. El proceso de galvanización permite depositar plata pura al 999,99% con espesores elevados que permiten un empleo prácticamente ilimitado. La alpaca, por su naturaleza, tiene características y comportamientos muy similares a los de la plata maciza. De hecho, el peso específico, la maleabilidad, conductibilidad térmica, color cálido, agradable envejecimiento, son todas características de metal noble.

Besser bekannt unter der Bezeichnung EPNS (Electro Plated Nickel Silver), handelt es sich um eine wertvolle Legierung aus Kupfer, Zink und Nickel. Der hier von Broggi 1818 eingesetzte Nickelanteil verbessert wesentlich die mechanischen Merkmale und die Widerstandsfähigkeit der Legierung. Der Galvanisierungsprozess ermöglicht die hochgradige Ablagerung von Reinsilber zu 999,99%, womit praktisch ein unbeschränkter Einsatz des verarbeiteten Artikels gewährleistet ist. Alpaka oder Neusilber hat von Natur her Eigenschaften und "Verhaltensweisen", die schwerem Silber sehr ähnlich sind. Eigengewicht, Verformbarkeit, Wärmeleitung, der warme Farbton und hervorragende Alterung machen es zu einem echten Edelmetall.

Posateria Alpacca Argentata

Cutlery - Electro - Plated Nickel Silver
Couverts - Maillechort argenté
Cubiertos - Alpaca plateada
Besteck - Alpacca versilbert

Meglio conosciuta come EPNS (Electro Plated Nickel Silver), si tratta di una lega pregiata di rame, zinco e nichel. L'alta concentrazione di nichel presente nella lega utilizzata da Broggi 1818 ne migliora le caratteristiche meccaniche e la resistenza. Il processo di galvanizzazione permette di depositare argento puro al 999,99% con spessori elevati che ne consente l'utilizzo pressoché illimitato. L'alpacca, per sua natura, ha caratteristiche e comportamenti molto simili all'argento massiccio. Infatti, peso specifico, malleabilità, conducibilità termica, colore caldo, invecchiamento gradevole, sono tutte caratteristiche da metallo nobile.





Classic
Alpacca - EPNS

Alpacca Argentata



Beatrice

alpacca super argentata
electro-plated nickel silver (EPNS)
cod. 103...



Ciga

alpacca super argentata
electro-plated nickel silver (EPNS)
cod. 067...

Alpacca Argentata



Visconti

alpacca super argentata
electro-plated nickel silver (EPNS)
cod. 031...



Alpacca Argentata



Serbelloni

alpacca super argentata
electro-plated nickel silver (EPNS)
cod. 010...



005...009

005...010

Belgioioso
alpacca super argentata
electro-plated nickel silver (EPNS)
cod. 005...

Alpacca Argentata



Castiglione

alpaca super argentata
electro-plated nickel silver (EPNS)
cod. 016...



Alpacca Argentata



Borromeo

alpacca super argentata
electro-plated nickel silver (EPNS)
cod. 008...



Sforza

alpacca super argentata
electro-plated nickel silver (EPNS)
cod. 068...

Alpacca Argentata



Liberty

alpacca super argentata
electro-plated nickel silver (EPNS)
cod. 020...



Sormani

alpacca super argentata
electro-plated nickel silver (EPNS)
cod. 063...

Alpacca Argentata



Bernini

alpaca super argentata
electro-plated nickel silver (EPNS)
cod. 011...



Excelsior

alpacca super argentata
electro-plated nickel silver (EPNS)
cod. 075...

Complementi



.065 Apribottiglie

Bottle opener
Décapsuleur
Abrebotellas
Flaschenöffner



.028 Cucchiaio servire insalata, aderenza metacrilato

Salad serving spoon, acrylic head
Cuillère à servir salade, cuilleron acrylique
Cucharón servir ensalada, cabeza acrílica
Serviersalatlöffel



.445 Cucchiaio tapas

Tapas spoon
Cuillère à tapas
Cuchara tapas
Tapas - Löffel



.040 Pala torta seghettata

Cake server, serrated edge
Pelle à tarte, dentellé
Pala tarta dentada
Tortenschaufel



.140 Coltello panettone

Cake knife
Couteau à pain
Cuchillo pan
Brotmesser



.061 Coltello trinciare

Carving knife
Couteau à découper
Cuchillo de trinchar
Tranchiermesser



.062 Forchetta trinciare

Carving fork
Fourchette à découper
Tenedor de trinchar
Tranchiergabel



**.029 Forchetta servire insalata
aderenza metacrilato**

Salad serving fork, acrylic head
Fourchette à servir salade, tête acrylique
Tenedor servir ensalada, cabeza acrílica
Serviersalatgabel



.056 Coltello formaggio duro a due punte

Hard cheese knife, two-prong
Couteau à fromage à pâte dure, deu x dents
Cuchillo queso de pasta dura, dos puntas
Hartkäsemesser mit 2 Spitzen



.057 Coltello formaggio a pasta molle

Soft cheese knife
Couteau à fromage à pâte molle
Cuchillo queso de pasta blanda
Weichkäsemesser



.085 Schiaccianoci

Nutcracker
Casse-noi x
Cascanueces
Nußnacker



.125 Pinza champagne

Champagne pliers
Pince à champagne
Pinzas para champán
Champagnerzange



LUNGHEZZA POSATE (MM.)







CUTLERY LENGTH (MM.)

alpacca argentata
electro-plated nickel silver (EPNS)



TIPOLOGIA

		COD. 103 00 ..	COD. 067 00 ..	COD. 031 00 ..	COD. 010 00 ..	COD. 005 00 ..
		Mod. 103 BEATRICE	Mod. 67 CIGA	Mod. 31 VISCONTI	Mod. 10/R SERBELLONI	Mod. 05 BELGIOIOSO
001	Cucchiaino tavola <i>Table spoon</i>	211	212	216	203	212
002	Forchetta tavola / Carne** <i>Table fork</i>	215	217	219	204	215
003	Cucchiaino brodo <i>Soup spoon</i>		180	178		
009	Coltello tavola manico cavo <i>Table knife, hollow handle</i>	246	240	246	239	252
011	Cucchiaino frutta / Risotto** <i>Dessert spoon</i>	184	190	188	188	184
012	Forchetta frutta <i>Dessert fork</i>	182	186	190	188	185
019	Coltello frutta manico cavo <i>Dessert knife, hollow handle</i>	217	212	219	215	211
021	Cucchiaino the <i>Tea spoon</i>	137	147	143	145	143
022	Cucchiaino moka <i>Moka spoon</i>	103	119	119	119	115
025	Mestolo 130 ml - 4 oz <i>Soup ladle</i>		287	315	305	295
026	Forchetta servire <i>Serving fork</i>		244	267	244	245
027	Cucchiaino servire <i>Serving spoon</i>		246	278	245	247
028	Cucchiaino servire insalata <i>Salad serving spoon</i>		242	240	226	237
029	Forchetta servire insalata <i>Salad serving fork</i>		242	240	228	237
031	Forchetta pesce <i>Fish fork</i>		199	198	197	193
032	Coltello pesce <i>Fish knife</i>		229	229	230	225
033	Forchetta servire pesce <i>Fish serving fork</i>		246	251	238	246
034	Coltello servire pesce <i>Fish serving knife</i>		279	276	274	279
035	Cucchiaino bibita <i>Iced tea spoon</i>					178
037	Paletta gelato <i>Ice cream spoon</i>		143	141	144	141
038	Forchetta dolce <i>Cake fork</i>		163	157	162	162
039	Pala torta <i>Cake server</i>		269	273	265	270
042	Mestolino salsa 22 ml - 0,75 oz <i>Sauce ladle</i>		160	162	160	159
043	Coltello burro m. cavo <i>Butter knife, hollow handle</i>	169	164	168	163	157
055	Coltello carne manico cavo <i>Steak knife, hollow handle</i>	209	213	217	216	208
061	Coltello trinciare <i>Carving knife</i>		313	318	311	310
062	Forchetta trinciare <i>Carving fork</i>		265	272	257	260
063	Forchetta lumache <i>Snail fork</i>					132
064	Forchetta ostriche <i>Oyster fork</i>					
067	Cucchiaino salsa <i>Gourmet spoon</i>	184	190	188	188	184

						
COD. 016 00 ..	COD. 008 00 ..	COD. 068 00 ..	COD. 020 00 ..	COD. 063...	COD. 011 00 ..	COD. 075 00 ..
Mod. 16 CASTIGLIONE	Mod. 08 BORROMEO	Mod. 68 SFORZA	Mod. 20 LIBERTY	Mod. 63 SORMANI	Mod. 11 BERNINI	Mod. 75 EXCELSIOR
204	212	207	207	202	212	215
208	215	211	215	204	215	220
		174				
242	259	241	240	235	242	254
178	182	184	187	171	182	186
178	185	181	190	173	182	193
209	220	210	210	210	215	227
140	142	143	142	134	142	149
115	118	106	117	104	106	105
320	303	280	297	275	291	295
243	243	237	244	224	263	261
245	243	240	244	222	269	261
241	245	243	241	230	245	
241	245	243	241	230	245	
188	193	195	196	172	194	195
222	225	223	222	198	224	228
245	246	238	237	235	240	
279	276	272	274	265	279	
	140	138	144	131	137	145
158	159	158	156	150	153	
265	270	262	266	250	265	
152	155	156	161	138	156	202
160	168	159	159	153	164	162
222	215	207	209	205	214	214
309	316	310	285	304	308	
260	265	265	265	250	268	
178	182	184	187	204	182	186

Grazie a una lunga storia di collaborazione con il cliente nella creazione di soluzioni su misura, oggi Broggi vanta un patrimonio esclusivo di marchi, stemmi, incisioni e fregi. Questa nostra distintiva competenza, ormai rara, consiste nell'offrire un servizio completo che esalta ogni realtà attraverso la personalizzazione unica del prodotto.

Personalizzazioni

Incisione del logo

L'incisione del logo o del nome del cliente viene eseguita con precisione mediante scalfittura, senza asportazione di materiale. Utilizziamo pantografi dotati di punta di diamante o, alternativamente, incisione laser per garantire dettagli raffinati e duraturi.

Punzonatura dello stemma

Per la punzonatura degli stemmi realizziamo punzoni e relativi controstampi, permettendo di imprimere il logo desiderato nel pezzo attraverso macchine punzonatrici specializzate. Questo processo assicura un risultato impeccabile e definito.

Applicazione a rilievo

Gli stemmi in rilievo vengono applicati tramite saldobrasatura, con possibilità di personalizzazione per materiali e dimensioni. Questa versatilità consente di adattare i loghi ai pezzi su cui vengono applicati, garantendo sempre un risultato armonioso.

Personalizzazione

Per lotti significativi di vasellame, offriamo un servizio di personalizzazione esclusiva sostituendo componenti predefiniti con elementi su misura. Ad esempio, per un vassoio è possibile sostituire le maniglie, per i sottopiatte modificare le bordure, o per le caffettiere intervenire su manici, pomoli o beccucci.

Studio e realizzazione di nuovi prodotti

Sviluppiamo nuovi articoli su richiesta, progettati per soddisfare le specifiche esigenze del cliente. Siamo in grado di realizzare modifiche parziali o sostanziali sugli articoli esistenti e applicare finiture superficiali personalizzate, come satinature, dorature, bruniture e molto altro.

Rimessa a nuovo di prodotti storici

Offriamo un servizio esclusivo di restauro per prodotti storici in alpaca. Attraverso lavorazioni accurate come ribaditura delle superfici, sgrassatura, riargentatura, ravvivatura e sostituzione di componenti danneggiati, riportiamo ogni pezzo allo splendore originale.

Thanks to a long-standing history of collaboration with clients in creating bespoke solutions, today Broggi boasts an exclusive heritage of brands, crests, engravings, and emblems.

This distinctive expertise—now increasingly rare—lies in offering a complete service that enhances each business through unique product customization.

Customizations

Logo engraving

Customer logos or names are engraved with precision through a scoring technique that does not remove material.

We use pantographs equipped with diamond tips or, alternatively, laser engraving to ensure refined and lasting details.

Logo punching

To stamp crests, we create punches and corresponding dies, allowing the desired logo to be imprinted onto the piece using specialized stamping machines. This process ensures an impeccable and well-defined result.

Embossing

Raised emblems are applied using brazing, with the possibility of customizing materials and dimensions.

This versatility allows the logos to adapt to the pieces they are applied to, always ensuring a harmonious result.

Component customisation

For significant batches of tableware, we offer an exclusive customization service by replacing standard components with bespoke elements. For example, tray handles can be substituted, charger plate borders modified, or coffee pot handles, knobs, and spouts redesigned.

Design and development of new products

Based on a client's specific requirements and needs, we can design We develop new items upon request, designed to meet the client's specific needs. We can carry out partial or substantial modifications to existing products and apply personalized surface finishes such as satinizing, gilding, bronzing, and more.

Restoration of historic items

We offer an exclusive restoration service for historic alpaca (nickel silver) pieces. Through meticulous processes such as surface planishing, degreasing, re-silvering, polishing, and replacement of damaged components, we restore each item to its original splendor.

Personalizzazioni

Customisation



The vastly wide range of Broggi 1818 complements is

the natural completion to the cutlery that we create. Suitable for specific or refined employments, some of them, as for instance the truffle cutter or the lobster cracker, come from the story and from the bicentenary tradition of craftsmanship of exclusive objects that belong to us; others, like the chopsticks or the appetizer spoons, are tools developed in recent times, in response to the needs and to the contemporary uses and are meant with the purpose of satisfying even the most special requirement of our clients.

La vaste gamme des accessoires Broggi 1818 est la

intégration naturelle aux couverts que nous créons. Aptes à l'usage pour utilisations spécifiques ou raffinés, certains d'entre eux, comme par exemple le coupe-truffes et la pince à homard, descendent de l'histoire et de la tradition bicentenaire de la production artisanale d'objets exclusifs qui nous appartient; autres, et cela est le cas des baguettes chinoises ou des cuillères de mise en bouche, sont outils développés dans les temps récents, répondent aux nécessités des emplois contemporains et naissent en vue de satisfaire même l'exigence la plus particulière de nos clients.

La amplísima gama de los accesorios Broggi 1818 es

la natural integración a la cubertería que creamos. Aptos para la utilización para usos específicos o refinados, algunos de estos, como por ejemplo el cortatrufas y las pinzas langostas, descendieron de la historia y de la bicentenaria tradición de producción artesanal de objetos exclusivos que nos pertenece; otros, como los palillos chinos o las cucharas aperitivo, son utensilios desarrollados en los tiempos recientes, responden a las necesidades de los usos contemporáneos y nacen con el objetivo de satisfacer incluso la exigencia más especial de nuestros clientes.

Die breite Produktpalette von Broggi 1818 Zubehör

ist die natürliche Integration in unsere Besteck. Einige von ihnen, wie der Trüffelschneider und die Krustentierzange, sind für bestimmte oder raffinierte Zwecke geeignet und stammen von unserer Geschichte und zweihundertjährigen Tradition der handwerklichen Herstellung exklusiver Objekte ab. Andere, wie Essstäbchen oder Vorspeisen, sind Werkzeuge, die in jüngster Zeit entwickelt wurden. Sie reagieren auf aktuelle Bedürfnisse und Verwendungszwecke und sind geboren mit dem Ziel alle besonderen Bedürfnisse unserer Kunden zu befriedigen.

Complementi

Acciaio

Accessories - St. Steel
Accessoires - Acier Inox
Accesorios - Acero Inox
Küchenzubehör - Edelstahl

La vastissima gamma dei complementi Broggi 1818 è

la naturale integrazione alla posateria che creiamo. Atti all'utilizzo per usi specifici o raffinati, alcuni di essi, come ad esempio il tagliatartufi e le pinze aragosta, discendono dalla storia e dalla bicentenaria tradizione di produzione artigiana di oggetti esclusivi che ci appartengono; altri, e questo è il caso dei chopsticks o degli appetizers, sono utensili sviluppati nei tempi recenti, rispondono alle necessità agli usi contemporanei e nascono nell'ottica di soddisfare anche la più speciale esigenza dei nostri clienti.



Coltello carne Damasco lama damascata manico ulivo

Damascus steak knife damascened blade olive handle
 Couteau à viande Damasco lame damasquinée manche olivier
 Cuchillo carne Guinea hoja bruñida mango de ébano
 Damast-Steakmesser mit damaszener Klinge und Olivengriff



	Cm	In
305 05 91 833	23	9
Lama damascata - Smooth blade		

Coltello carne Guinea lama brunita manico ebano

Guinea steak knife burnished blade ebony handle
 Couteau à viande Guinea lame brunie manche en ébène
 Cuchillo carne Guinea hoja bruñida mango de ébano
 Guinea-Steakmesser mit brüniertes Klinge und Griff aus Ebenholz



	Cm	In
305 05 91 834	23	9
Lama brunita - Burnished blade		

Coltello carne Bali manico in Pakkawood

Bali steak knife colour Pakkawood handle
 Couteau à bifteck Bali manche Pakkawood
 Cuchillo carne Bali mango de Pakkawood
 Steakmesser Bali mit Pakkawoodgriff

	Cm	In
3050591830	21,5	8,1/2
Manico nero - Black handle		

	Cm	In
3050591831	21,5	8,1/2
Manico Mogano - Mahogany handle		

	Cm	In
3050591832	21,5	8,1/2
Manico Acero - Maple handle		



Coltello carne Osaka manico fibra di vetro

Osaka steak knife fibreglass handle
Couteau à viande Osaka manche en fibre de verre
Cuchillo carne Osaka con mango de fibra de vidrio
Osaka Steakmesser mit Glasfasergriff

	Cm	In
305 05 91 835	23,5	9,1/4

Manico fibra di vetro - Fibreglass handle



Coltello carne Java

Java steak knife
Couteau à viande Java
Cuchillo carne Java
Java Fleischmesser

	Cm	In
305 05 91 797	22,5	8,7/8

Manico nero - Black handle

	Cm	In
305 45 91 797	22,5	8,7/8

Manico avorio - Ivory handle



Coltello pizza Positano manico ABS

Positano pizza knife ABS handle
Couteau à pizza Positano manche en ABS
Cuchillo pizza Positano mango ABS
Positano Pizzamesser ABS-Griff

	Cm	In
305 05 91 836	21,5	8,1/2

Lama in acciaio lucido - Blade in polished steel

305 42 91 836	21,5	8,1/2
---------------	------	-------

Lama in finitura PVD - PVD blade



Coltello carne Marchesi acciaio

Marchesi steak knife, stainless steel
 Couteau à viande Marchesi en acier inox idable
 Cuchillo carne Marchesi en acero inox idable
 Filetmesser Marchesi, Edelstahl rostfrei

	Cm	In
117 05 01 059	23,8	9,1/2
Lama liscia - Smooth blade		

117 05 02 059	23,8	9,1/2
Lama seghettata - Serrated blade		



Forchetta carne Marchesi acciaio inox

Steak fork St. Steel
 Fourchette à steak en acier inoxydable
 Tenedor para bistec de acero inoxidable
 Steakgabel aus rostfreiem Stahl

	Cm	In
117 05 01 002	21,5	8 1/2



Coltello carne monoblocco

Steak knife, solid handle
 Couteau à viande, monobloc
 Cuchillo carne, monobloc
 Filetmesser Monoblock

	Cm	In
009 05 00 059	21	8,1/4



Nano

acciaio inox 18/10
stainless steel 18/10

Forchettina 3 punte

Fork, 3-prong

Petite fourchette à deu x pointes

Tenedor pequeño tres puntas Gabel mit 3 Zinken

Cm In

185 05 00 302 11,5 4,1/2



Cucchiaino

Tea spoon

Cuillère à café

Cucharita de tè

Teelöffel

Cm In

185 05 00 001 11,5 4,1/2



Forchettina 2 punte

Small fork, 2-prong

Petite fourchette à trois pointes

Tenedor pequeño dos puntas

Gabel mit 2 Zinken

Cm In

185 05 00 202 11,5 4,1/2



Forchettina 1 punta

Small fork, 1-prong

Tenedor pequeño uno puntas

Petite fourchette à un pointes

Gabel mit 1 Zinken

Cm In

185 05 00 102 11,5 4,1/2



Branch Bastoncini - Chopsticks

Branch Chopsticks
 Baguettes Branch
 Palillos Branch
 Zweig-Stäbchen

	Cm	In
118 05 00 082	22,5	10



Poggiaposate Branch

Branch cutlery stand
 Porte-couverts Branch en Acier Inox
 Posa cubiertos Branch en Acero Inox
 Besteckhalter Branch, Edelstahl

	Cm	In
118 05 00 081	7,5 x 3	2,8/9 x 1,1/5



Poggiabastoncini Ergo

Ergo cutlery stand St.Steel
 Porte-baguettes Ergo en Acier Inox
 Posa palillos Ergo en Acero Inox
 Essstäbchenhalter Ergo, Edelstahl

	Cm	In
903 05 84 662	5,6	2,1/8



Molla Finger Food

Finger food tong
 Piece à finger food
 Pinzas finger food
 Fingerfood Zange

	Cm	In
185 05 00 044	11,5	4,1/2



Complementi

Stiletto crostacei

Oyster pick
Curette à crustacés
Tenedor mariscos
Auster / Krustazeengabel

	Cm	In
CPA 64	22,7	8,7/8



Stiletto aragosta

Lobster pick
Fourchette à homard
Tenedor langosta
Langustegabel

	Cm	In
903 05 84 659	20,2	7,7/8



Pinza aragosta

Lobster cracker
Pince à homard
Pinzas langostas
Langustezange

	Cm	In
305 05 91 660	22,5	8,7/8



Schiaccianoci in Acciaio Inox

Nutcracker St.Steel
Casse-noi x Acier Inox
Cascanueces Acero Inox
Nußknacker "Regis"

	Cm	In
305 05 91 512	22	8,5/8



Forchettina ostriche Palio

Palio oyster fork
Fourchette à huîtres Palio
Tenedor ostras Palio
Palio Austerngabel

	Cm	In
165 05 00 064	15,6	6,1/8



Forchettina lumache Palio

Palio snail fork
Fourchette à escargots Palio
Tenedor caracoles Palio
Palio Schneckengabel

	Cm	In
165 05 00 063	15,6	6,1/8



Molla lumache

Snail tong
Pince à escargots
Pinzas caracoles
Schneckenzange

	Cm	In
305 05 81 549	16	6,1/4



Cucchiaino the/moka Giubileo

Tea/moka Spoon Giubileo
Petite cuillère à thé/moka Jubilé
Cucharilla de té/moka Jubileo
Teelöffel/moka-löffel Jubiläum

	Cm	In
185 05 00 021	13	5 1/8
185 05 00 022	11	4 3/8



Complementi

Appetizer tondo, cucchiaio

Appetizer curved spoon
Cuillère de mise en bouche ronde pliée
Cuchara aperitivo redonda plegada
Appetizer - rund gebogener Löffel

	Cm	In
305 05 81 696	14	5,1/2



Appetizer con piega, cucchiaio

Bended appetizer, spoon
Cuillère de mise en bouche pliée
Cuchara aperitivo plegada
Appetizer Löffel

	Cm	In
165 05 00 175	14	5,1/2



Appetizer con riccio, cucchiaio

Curled appetizer, spoon
Cuillère de mise en bouche en boucle
Aperitivo con nudo, cuchara
Appetizer Löffel

	Cm	In
165 05 00 174	14	5,1/2



Cucchiaio tapas

Tapas spoon
Cuillère a tapas
Cuchara tapas
Tapas Löffel

	Cm	In
CF1 TA	17	6,34



Raccoglibriciole

Crumb scraper
Ramasse-miettes
Recogemigas
Krümelsammler

	Cm	In
903 05 91 939	15	6



Molla zucchero/ghiaccio

Sugar/ice tongs

Pince à sucre/glace

Pinzas azúcar/hielo

Zucker/Eiszange

	Cm	In
305 05 81 545	12,6	4,7/8
305 05 81 538	18	7



Molla per antipasti

Hors d'oeuvre tongs

Pince à hors d'oeuvre

Pinzas entremeses

Vorspeisenzange

	Cm	In
305 05 81 544	21	8,1/4



Molla pasticceria/pane

Pastry / bread tong

Pince à gâteau / pain

Pinzas pasteles / pan

Gebäck / brotzange

	Cm	In
305 05 81 539	18	7
305 05 81 540	23	8,1/4



Complementi

Forbici servire pane

Bread tongs
Ciseau x à pain
Tijeras servir pan
Brotzange

	Cm	In
305 05 91 821	25	8,7/8



Forbici servire arrosto

Roast tongs
Ciseau x à rôti
Tijeras servir asado
Fleischzange

	Cm	In
305 05 91 822	25	8,7/8



Forbici servire pasticceria

Pastry tongs
Ciseau x à pâtisserie
Tijeras servir pastelería
Gebäckzange

	Cm	In
305 05 91 820	21	8,1/4



Coltello pane/panettone manico vuoto

Panettone knife hollow handle
Couteau à tarte lame dentelé, manche creuse
Cuchillo pastel dentado, mango hueco
Kuchmesser, holem Heft

	Cm	In
305 05 91 817	28,5	11,1/4



Forchettone arrosto manico vuoto

Roast serving fork hollow handle
Grande fourchette rôti, manche creuse
Tenedor asado, mango hueco
Fleischgabel, holem Heft

	Cm	In
305 05 91 818	27,5	10,4/5



Coltello arrosto manico vuoto

Roast serving knife hollow handle
Couteau à bifteck, manche creuse
Cuchillo carne, mango hueco
Filetmesser, holem Heft

	Cm	In
305 05 91 819	31,5	12,3/8



Cucchiaine buffet

Buffet serving spoon
Cuillère à servir buffet
Cucharón servir buffet
Buffetservierlöffel

	Cm	In
122 05 02 710	34	13,38

Cucchiaine buffet forato

Buffet slotted serving spoon
Cuillère à servir trouée buffet
Cucharón servir con agujeros buffet
Buffetservierlöffel mit Schlitzen

	Cm	In
122 05 02 720	34	13,38

Cucchiaine servire

Serving spoon
Cuillère à servir
Cucharón servi
Servierlöffel

	Cm	In
122 05 00 027	22,7	9

Forchettone servire

Serving fork
Fourchette à servir
Tenedor servir
Serviergabel

	Cm	In
122 05 00 026	22,7	9

Cucchiaine servire forato

Slotted serving spoon
Fourchette à servir trouée
Tenedor servir con agujeros
Servierlöffel mit Schlitzen

	Cm	In
122 05 01 460	22,7	9

Mestolo servire

Serving ladle
Louche à servir
Cazo servir
Servierkelle

	Cm	In
122 05 00 025	30,4	12

Mestolino punch

Punch ladle
Louche à punch
Cazo punch
Punch Kelle

	Cm	In
122 05 02 520	28,5	11,1/4



122 05 02 710

122 05 02 720

122 05 00 027

122 05 00 026

122 05 01 460

122 05 00 025

122 05 02 520

Forchettone insalata

Salad serving fork
Fourchette à servir salade
Tenedor servir ensalada
Salatgabel

	Cm	In
122 05 00 029	227	9

Cucchiandone insalata

Salad serving spoon
Cuillère à servir salade
Cucharón servir ensalada
Salatlöffel

	Cm	In
122 05 00 028	22,7	9

Cucchiandone riso

Rice serving spoon
Cuillère à servir riz
Cuchara servir arroz
Reislöffel

	Cm	In
122 05 01 430	25	9,7/8

Pala dolce

Cake server
Couteau à gâteau
Pala para pastel
Tortenheber

	Cm	In
122 05 00 039	24	9,1/2

Mestolo

Serving ladle
Louche à servir
Cazo servir
Servierkelle

	Cm	In
122 05 02 510	19,8	7,7/8

Mestolino salsa

Sauce ladle
Loche à sauce
Cazito salsa
Suppenkelle

	Cm	In
122 05 01 442	15,3	5,7/8



122 05 00 029

125 05 00 028

122 05 01 430

122 05 00 039

122 05 02 510

122 05 01 442

Complementi

Cucchiaine ghiaccio professionale

Professional ice-serving spoon
Cuillère à servir glaçons professionnelle
Cucharón servir hielo profesional
Eislöffel

	Cm	In
903 05 91 063	29	11,1/2



Cucchiaine insalata professionale

Professional salad-serving spoon
Cuillère à salade professionnelle
Cucharón ensalada profesional
Salatlöffel

	Cm	In
903 05 91 066	28,5	11,1/4



Cucchiaine servire professionale

Professional serving spoon
Cuillère à servir professionnel
Cucharón servir profesional
Servierlöffel

	Cm	In
903 05 91 793	29	11,1/2



Forchettone servire professionale

Professional serving fork
Fourchette à servir professionnelle
Tenedor servir profesional
Serviergabel

	Cm	In
903 05 91 794	29,4	11,5/8



Forchettone arrosto professionale

Professional carving fork
Grande fourchette rôti professionnelle
Fleischgabel
Tenedor asado profesional

	Cm	In
903 05 91 064	28,5	11,1/4



Spatola crepes professionale

Professional crepes server
Spatule à crêpes professionnelle
Pala crepes profesional
Crepepschaufel

	Cm	In
903 05 91 065	29,2	11,8/2



Mestolo professionale

Professional ladle
Louche professionnelle
Professionelle Schöpfkelle
Cazo profesional

	Cm	In
903 05 91 025	28,8	11,3/4



Coltello torta professionale seghettato

Professional cake knife, serrated-edge
Couteau à tarte professionnel lame dentelée
Cuchillo tarta profesional dentado
Tortenmesser

	Cm	In
903 05 91 788	29,7	11,3/4



Pala torta professionale

Professional cake server
Pelle à tarte professionnelle
Pala tarta profesional
Tortenschaufel

	Cm	In
903 05 91 799	29,7	11,3/4



Pala torta seghettata professionale

Professional cake server, serrated-edge
Pelle à tarte professionnelle lame dentelée
Pala tarta profesional dentada
Tortenschaufel

	Cm	In
903 05 91 786	29,7	11,3/4



Pala gratin professionale seghettata

Professional gratin server, serrated-edge
Pelle à gratin professionnelle dentelée
Pala lasaña profesional dentada
Lasagne-Spachtel, gezahnt

	Cm	In
903 05 91 787	26,8	10,5/8



Cucchiaio riso forato professionale

Professional rice-serving spoon
Cuillère à riz professionnelle
Reislöffel
Cucharón arroz profesional

	Cm	In
903 05 91 795 F	25,6	10



Cucchiaione riso professionale

Professional rice-serving spoon
Cuillère à servir riz professionnelle
Cucharón servir arroz profesional
Reislöffel

	Cm	In
903 05 91 795	25,6	10



Pala fritto professionale

Professional frying shovel
Pelle à frire professionnelle
Pala fritos profesional
Schaufel

	Cm	In
903 05 91 062	29,5	11,5/8



Cucchiaione forato professionale

Professional serving spoon perforated
Cuillère à servir perforé professionnel
Cucharón servir con agujeros profesional
Servierlöffel, gelocht

	Cm	In
903 05 91 796	29	11,1/2









Mix&Match

Poggiaposate Piatto





Cutlery stand, flat
Porte-couverts plat
Posa cubiertos plano
Besteckhalter flach

	Cm	In	colore/color
 305 04 81 722	25 x 8,5	9,7/8 x 3,3/8	noce/walnut
 305 04 81 723	25 x 8,5	9,7/8 x 3,3/8	wengè/wenge
 305 04 81 724	25 x 8,5	9,7/8 x 3,3/8	grigio/grey
 305 04 81 725	25 x 8,5	9,7/8 x 3,3/8	nero/black



Poggiaposate Curvo



Cutlery stand, curved
Porte-couverts courbé
Posa cubiertos onda
Besteckhalter gebogen

	Cm	In	colore/color
 305 04 81 726	26 x 8,5	10,1/4 x 3,3/8	noce/walnut
 305 04 81 727	26 x 8,5	10,1/4 x 3,3/8	wengè/wenge
 305 04 81 728	26 x 8,5	10,1/4 x 3,3/8	grigio/grey
 305 04 81 729	26 x 8,5	10,1/4 x 3,3/8	nero/black



Poggiaposate double face

Cutlery stand double-sided
Porte-couverts double-face
Posa cubiertos reversible
Besteckhalter, beidseitig

	Cm	In	colore/color
 305 04 81 716	25 x 8,5 x 2,5	9,7/8 x 3,3/8	wengè + noce wenge + walnut
 305 04 81 717	250 x 85 x 2,5	9,7/8 x 3,3/8	nero + grigio black + grey



FINITURE DISPONIBILI AVAILABLE FINISHES



Wengé
Wenge

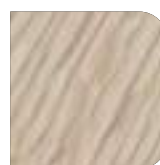

Noce
Walnut



Nero
Black



Grigio
Grey



Poggiaposate curvo in acciaio

Cutlery stand curved St.Steel
Porte-couverts courbé en Acier Inox
Posa cubiertos curvado en Acero Inox
Besteckhalter gebogen, Edelstahl

	Cm	In
305 05 81 732	8,5 x 8,5	3,3/8 x 3,3/8



Poggiaposate piatto in acciaio

Cutlery stand flat St.Steel
Porte-couverts plat en Acier Inox
Posa cubiertos plano en Acero Inox
Besteckhalter flach, Edelstahl

	Cm	In
305 05 81 733	8,5 x 8,5	3,3/8 x 3,3/8



Sottobicchiere in acciaio double face lucido/satinato

Double sided mirror/mat glass coaster
Dessous de verre Acier Inox double-face poli/brossé
Posavasos reversible Acero Inox pulido/satinado
Glassuntersetzer; beideseitig, Edelstahl, glänzend-matt

	Cm	In
305 05 21 538	8,5 x 8,5	3,3/8 x 3,3/8



Sottobicchiere tondo in acciaio double face lucido/satinato

Double sided mirror/mat glass coaster, round,
Dessous de verre rond Acier Inox double-face poli/brossé
Posavasos redondo reversible Acero Inox pulido/satinado
Glassuntersetzer rund; beideseitig, Edelstahl, glänzend-matt

	Ø Cm	Ø in
305 05 21 541	9	3,1/2





Poggiaposate rettangolare acc. inox

Cutlery stand rectangular St.Steel
Porte-couverts rectangulaire Acier Inox
Posa cubiertos rectangular en Acero Inox
Besteckhalter, Edehlstahl

	Cm	In
305 05 81 742	9 x 1,5	3 1/2 x 0 5/8

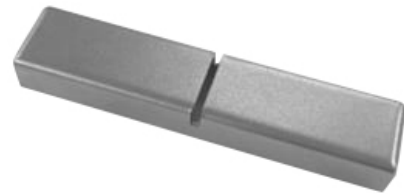

Poggiaposate tondo

Cutlery stand round St.Steel
Porte-couverts rond en Acier Inox
Posa cubiertos redondo en Acero Inox
Besteckhalter rund, Edehlstahl

	Cm	In
305 05 81 713	Ø 8,5	Ø 3,3/8



Poggiaposate Branch

Branch cutlery stand
Porte-couverts Branch en Acier Inox
Posa cubiertos Branch en Acero Inox
Besteckhalter Branch, Edelstahl

	Cm	In
118 05 00 081	7,5 x 3	2,8/9 x 1,1/5



Poggiabastoncini Ergo

Ergo cutlery stand St.Steel
Porte-baguettes Ergo en Acier Inox
Posa palillos Ergo en Acero Inox
Esst bchenhalter Ergo, Edelstahl

	Cm	In
903 05 84 662	5,6	2,1/8





Legatovagliolo Spirale

Napkin ring, spiral , St. Steel
Rond de serviettes spirale Acier Inox
Servilletero individual espiral Acero Inox
Serviettenring Spirale, Edelstahl

	Cm	In
305 05 81 730	7 x 5	2,3/4 x 1,8/9



Legatovagliolo Ovale

Napkin ring, oval St. Steel
Rond de serviettes oval Acier Inox
Servilletero individual oval Acero Inox
Serviettenring Spirale, Edelstahl

	Cm	In
305 05 81 731	6 x 3	2,3/8 x 1,1/5



Legatovagliolo Tondo

Napkin ring, round St. Steel
Rond de serviettes rond Acier Inox
Servilletero individual redondo Acero Inox
Serviettenring rund, Edelstahl

	Cm	In
V01 05 81 001	Ø 4	Ø 1,2/3



Legatovagliolo / poggiabastoncini Bamboo

Napkin ring / cutlery stand Bamboo St. Steel
Rond de serviettes/porte-baguettes Bamboo Acier Inox
Servilletero/posa palillos individual Bamboo Acero Inox
Serviettenring Bamboo, Edelstahl

	Cm	In
V01 05 81 005	6 x 4	2,3/8 x 1,2/3







Posateria - Cutlery

Finiture Speciali - Special Finishes

Finiture di tendenza e nuances raffinate che suscitano nuove sensazioni, trasmettono stile e personalizzano la mise en place.

Trendy finishes and refined nuances that arouse new sensations, convey style and personalise the mise-en-place.

Finitions de tendance et nuances raffinées qui donnent des sensations nouvelles, en transmettant style et en personnalisant la mise en place des tables.

Acabados de tendencia y tonos refinados que provocan nuevas sensaciones, transmiten estilo y personalizan la mise en place.

Trendige Oberflächen und raffinierte Nuancen, die neue Empfindungen wecken, Stil vermitteln und das Mise en Place personalisieren.

Vintage

L'opacità, i graffi ed i segni volutamente prodotti sulla superficie delle posate con finitura Vintage danno la sensazione di oggetti vissuti ed utilizzati a lungo, di grandi cucine profumate, calde e piene di vapore, di convivialità di altri tempi, di sapori antichi. Evocano immagini di ambienti tradizionali, rustici e senza pretese di modernità.

Opacity, scratches and marks intentionally made on the surface of the cutlery with a Vintage finish give the effect of objects that have been used for a long time, of a large, warm and steamy kitchen filled with aromas, of the friendly gatherings of old good times and ancient flavours. They evoke images of traditional, simple environments with no intention to be modern.

L'opacité, les égratignures et les marques intentionnellement produites sur la surface des couverts à finition Vintage donnent le sentiment d'objets vécus et utilisés depuis longtemps, de grandes cuisines odorantes, chaudes et pleines de vapeur, de convivialité d'autrefois, de saveurs d'antan. Elles évoquent des images de lieu x traditionnels, rustiques et sans prétention de modernité.

La opacidad, los rasguños y las marcas producidos deliberadamente en la superficie de los cubiertos con acabado Vintage dan la sensación de objetos vividos y utilizados por largo tiempo, de grandes cocinas perfumadas, cálidas y llenas de vapor, de convivialidad de otros tiempos, de sabores antiguos. Evocando imágenes de ambientes tradicionales, rústicos y sin pretensiones de modernidad.

Der Mattglanz, die "Kratzer" und gezielt in die Oberfläche eingearbeiteten Zeichen der Serie "Vintage" verleihen diesem Besteck einen besonders raffinierten Look von seit langem benutzten Gegenständen, erinnern an die Atmosphäre großer gemütlicher Wohnküchen von früher, wo es herrlich nach den Gerichten unserer Kindheit duftete. Sie rufen Bilder traditioneller Ambiente wach, ohne dem Anspruch moderner Stilformen nachzugeben.

Polvere di Luna

La finitura Polvere di Luna rende l'aspetto delle posate satinato e delicatamente brillante: una superficie levigata con chiaroscuri. Piacevoli e vellutate al tatto, trasmettono una morbidezza ed un calore inconsueto per oggetti di acciaio. Un rivestimento sobrio ed inusuale per posate contemporanee.

The Polvere di Luna finish makes cutlery surface look satin-like and delicately brilliant: a smooth surface with contrasting shades. Pleasant and velvety to the touch, the cutlery so treated convey a softness and warmth unusual for steel objects. A sober and unusual coating for contemporary cutlery.

La finition Polvere di Luna rend l'aspect des couverts satiné et délicatement brillant : une surface polie avec des clairs-obscur. Agréables et veloutées au toucher, ils transmettent une douceur et une chaleur insolites pour des objets en acier. Un revêtement sobre et inusuel pour des couverts contemporains.

El acabado Polvere di Luna confiere a los cubiertos un aspecto satinado y delicadamente brillante: una superficie pulida con claroscuros. Agradables y aterciopelados al tacto, transmiten una suavidad y una calidez insólitas en objetos de acero. Un revestimiento sobrio e inusual para cubiertos contemporáneos.

Die Oberflächenbearbeitung 'Polvere di Luna' verleiht dem Besteck samtlichen Glanz mit edlen hell-dunkel Schattierungen. Von ausgesprochen gepflegter Haptik, liegt dieses Besteck weich und besonders angenehm in der Hand und strahlt eine für Stahl ungewöhnliche Wärme aus. Ein dezentes und einzigartiges Oberflächenfinish für zeitgenössisches Besteck.

Scotch-Brite

Questo effetto superficiale, tipicamente utilizzato nell'architettura di interni, è caratterizzato dalla presenza di molteplici e lievissime graffiature longitudinali; dona al metallo una sembianza velata e luminosa al tempo stesso, conferendo agli oggetti che riveste un aspetto di brillantezza pacata, di acciaio non lucente. Per utensili che evocano il design di stile nordico.

This superficial effect, typically used in the interior architecture, is characterized by the presence of numerous and very light longitudinal scratches; it adds to the metal a veiled and bright appearance at the same time, bestowing to the objects it covers an aspect of measured brilliance, of non-glowing steel. For tools that evoke northern design.

Cet effet de surface, typiquement utilisé dans l'architecture d'intérieur, se caractérise par la présence de plusieurs et très légères éraflures longitudinales; cela rend le métal d'une apparence voilée et lumineuse en même temps, en donnant au x objets un aspect d'éclat paisible, d'acier pas brillant. Pour outils qui évoquent le design du style nordique.

Este efecto superficial, típicamente utilizado en la arquitectura de interiores, se caracteriza por la presencia de múltiples rasguños longitudinales; proporciona al metal una apariencia velada y luminosa al mismo tiempo, otorgando a los objetos que cubre un aspecto de brillo sosegado, de acero no reluciente. Para utensilios que evocan diseño de estilo nórdico.

Dieser Oberflächeneffekt, der typischerweise in der Innenarchitektur verwendet wird, charakterisiert sich für das Vorhandensein mehrerer und sehr geringer Längskratzer. Es verleiht dem Metall gleichzeitig einen verschleierten und leuchtenden Anschein und verleiht den Objekten, die es abdeckt, einen Aspekt ruhiger Brillanz und nicht glänzenden Stahls. Scotch-brite ist ideal für Werkzeuge, die an das nordische Design erinnern.





Vintage

cod. ...51

Finitura disponibile per tutti i modelli

Finish available for all models

Minimo di ordine 500 pz assortiti

500 assorted pcs minimum order

Minimum commande 500 pcs assortis

Pedido mínimo 500 pzs surtidas

Mindest Bestellung 500 stck gemischt



Polvere di Luna

cod. ...32

Finitura disponibile per tutti i modelli

Finish available for all models

Non disponibile per posate a manico cavo

Not available for hollow-handle cutlery

Minimo di ordine 500 pz assortiti

500 assorted pcs minimum order

Minimum commande 500 pcs assortis

Pedido mínimo 500 pzs surtidas

Mindest Bestellung 500 stck gemischt



Scotch-Brite

cod. ...73

Finitura disponibile per tutti i modelli

Finish available for all models

Non disponibile pr posate in PVD

Not available for PVD cutlery

Minimo di ordine 500 pz assortiti

500 assorted pcs minimum order

Minimum commande 500 pcs assortis

Pedido mínimo 500 pzs surtidas

Mindest Bestellung 500 stck gemischt

The PVD (Physical Vapour Deposition) technique allows to deposit a high-thickness metal film with remarkable characteristics from the decorative and technical point of view. Such process makes the product treated durable in time and gives high surface hardness. The item turns resistant to solvents, acids and to various products used in the kitchen, keeping its chemical/physical characteristics unchanged. It is a thoroughly biocompatible, anallergic treatment and suitable for food contact.

La technique PVD (Physical Vapour Deposition) permet de déposer un film métallique de haute épaisseur avec des caractéristiques surprenantes du point de vue décoratif et technique. Ce processus rend le produit traité durable et confère une dureté superficielle élevée. L'article devient résistant aux solvants, aux acides et aux différents produits employés en cuisine, gardant intactes ses propres caractéristiques chimio/physiques. C'est un traitement absolument biocompatible, anallergique et approprié au contact avec la nourriture.

La técnica PVD (Physical Vapour Deposition) permite depositar una película metálica de alto grosor con características sorprendentes desde el punto de vista decorativo y técnico. Este procedimiento hace que el producto tratado sea duradero en el tiempo y le confiere una elevada dureza superficial. El artículo se torna resistente a los solventes, a los ácidos y a los diversos productos empleados en la cocina, manteniendo intactas sus características químico/físicas. Es un tratamiento absolutamente biocompatible, antialérgico y apto para el contacto con los alimentos.

Die PVD Technik ermöglicht die Beschichtung mit einem dickwandigen Metallfilm von überraschenden dekorativen und technischen Merkmalen. Das Verfahren verleiht dem Produkt längere Lebensdauer und eine ausgeprägte Oberflächenhärte, macht beständig gegen Lösungsmittel, Säuren und verschiedene Haushaltsmittel, wobei die chemischen und physischen Eigenschaften des Produkts selbst intakt bleiben. Die Behandlung ist absolut bioverträglich, allergiefrei und lebensmitteltauglich.

PVD

La tecnica PVD (Physical Vapour Deposition) permette di depositare un film metallico di alto spessore con caratteristiche sorprendenti dal punto di vista decorativo e tecnico. Questo procedimento rende il prodotto trattato durevole nel tempo e conferisce elevata durezza superficiale. L'articolo diventa resistente ai solventi, agli acidi e a vari prodotti usati in cucina, mantenendo intatte le proprie caratteristiche chimico/fisiche. E' un trattamento assolutamente biocompatibile, anallergico ed idoneo al contatto con il cibo.

**Lucido
PVD oro**

Mirror PVD Gold
cod. ...41



**Lucido
PVD rame**

Mirror PVD Copper
cod. ...40



**Lucido
PVD nero**

Mirror PVD Black
cod. ...42



**Lucido
PVD bronzo**

Mirror PVD Bronze
cod. ...85



**Lucido
PVD Champagne**

Mirror PVD Champagne
cod. ...80





FinitureSpeciali

Polvere di Luna PVD oro

Moon dust PVD Gold
cod. ...35



Polvere di Luna PVD rame

Moon dust PVD Copper
cod. ...53



Polvere di Luna PVD nero

Moon dust PVD Black
cod. ...39



Polvere di Luna PVD bronzo

Moon dust PVD Bronze
cod. ...83



Polvere di Luna PVD champagne

Moon dust PVD Champagne
cod. ...78





Vintage PVD oro

Vintage PVD Gold
cod. ...57



Vintage PVD rame

Vintage PVD Copper
cod. ...56



Vintage PVD nero

Vintage PVD Black
cod. ...75



Vintage PVD bronz

Vintage PVD Bronze
cod. ...84







Foscari

Finiture speciali - Special Finishes

La finezza dei dettagli abilmente cesellati si apre a diverse variazioni dal sapore attuale, grazie alla scelta delle finiture speciali in grado di diversificare il look della posata.

The fineness of the skilfully chiselled details opens up to various variations with a contemporary flavour, thanks to the choice of special finishes that can diversify the look of the cutlery.



FinitureSpeciali

Lucido acciaio
Steel Polished
cod. ...05

Lucido argentato
Silver-plated Polished
cod. ...07

Lucido gold
Gold Polished
cod. ...41

Lucido copper
Copper Polished
cod. ...40

Lucido black
Absolute black Polished
cod. ...74





Antique acciaio

Antique Antique
cod. ...51



Antique argentato

Silver-plated Antique
cod. ...59



Antique gold

Gold Antique
cod. ...57



Antique copper

Copper Antique
cod. ...56



Antique black

Black Antique
cod. ...76



Antique 1905
1905 Antique
cod. ...63





Vasellame - Hollowware

Finiture speciali - Special Finishes



The range of special finishes can be applied to hollowware products as well, creating contemporary taste combinations. Matching finishes and colours you can customise your style, enhancing it with new looks and unusual effects.

La gamme de finitions spéciales peut être appliquée au x accessoires aussi, en créant combinaisons du goût contemporain. En assortant finitions et couleurs il est possible de personnaliser son propre style, en l'enrichissant par présentations nouvelles et effets inhabituels.

La gama de acabados especiales se puede aplicar en productos de vajilla también, creando mezclas de gusto contemporáneo. Combinando acabados y colores es posible personalizar su estilo, enriqueciéndolo con nuevas presentaciones y efectos insólitos.

Die Serie von Spezialoberflächen kann auch auf Geschirrprodukte angewendet werden. Auf diese Weise man kann Kombinationen mit einem zeitgemäßen Geschmack erschaffen. Durch die Kombination von Oberflächen und Farben können Sie Ihren eigenen Stil anpassen und ihn mit neuer Kleidung und ungewöhnlichen Effekten bereichern.

Vasellame - Hollowware

Finiture speciali - Special Finishes

La gamma di finiture speciali può essere applicata anche ai prodotti di vasellame, creando combinazioni dal gusto contemporaneo. Abbinando finiture e colori è possibile personalizzare il proprio stile, arricchendolo con vesti nuove ed effetti inconsueti.



**Lucido
PVD oro**

Mirror PVD Gold
cod. ...41

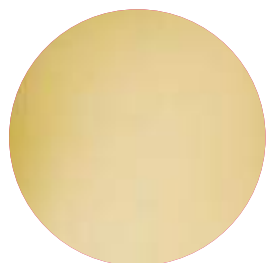

**Lucido
PVD rame**

Mirror PVD Copper
cod. ...40

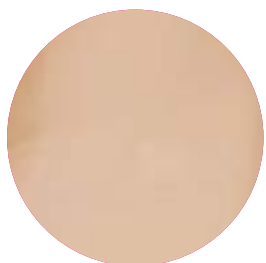

**Lucido
PVD nero**

Mirror PVD Black
cod. ...42



**Lucido
PVD champagne**

Mirror PVD Champagne
cod. ...80

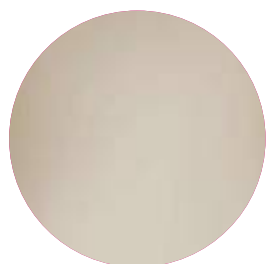



**Polvere di Luna
PVD oro**

Moon dust PVD Gold
cod. ... 35



**Polvere di Luna
PVD rame**

Moon dust PVD Copper
cod. ...53



**Polvere di Luna
PVD nero**

Moon dust PVD Black
cod. ...39



**Polvere di Luna
PVD champagne**

Moon dust PVD Champagne
cod. ...78





Vintage PVD oro

Vintage PVD Gold
cod. ...57



Vintage PVD rame

Vintage PVD Copper
cod. ...56



Vintage PVD nero

Vintage PVD Black
cod. ...58









Essenza

Acciaio - 18/10 St. Steel



Alzata grappolo 10 posizioni

Petit fours stand 10-dish Steel
 Plat à petits fours sur pied 10 places Acier
 Porta pasteles de té 10 plazas Acero
 Petit Fours Ständer 10-teilig Edelstahl

	Ø Cm	H Cm	Ø In	H In
335 05 41 599	17 x 19	21	6,3/4 x 7,1/2	8,1/4



Alzata grappolo 6 posizioni

Petit fours stand 6-dish Steel
 Plat à petits fours sur pied 6 places Acier
 Porta pasteles de té 6 plazas Acero
 Petit Fours Ständer 6-teilig Edelstahl

	Cm	H Cm	In	H In
335 05 41 603	20 x 17	19	7,7/8 x 6,3/4	7,1/2



Piatto piccola pasticceria con stelo

Petit-fours dish with stem
 Plat à petit fours avec tige
 Porta pasteles de té con tallo
 Petit-Fours Stand mit Stil

	Ø Cm	Ø In	H Cm	H In
335 05 41 601	12,5	5	14,5	5,3/4
335 05 41 602	16,5	6,1/2	18,5	7,1/4





Alzata pasticceria 3 piani, tonda

Pastry stand, 3-tier, round shaped
Présentoir à pâtisserie 3 étages rond
Soporte pastelería 3 pisos redondo
Petit Four Ständer 3-fach, Rund

	Cm	In	H cm	In
305 05 42 545	22 x 6,5	8,7 x 2,6	19,5	7,7



Alzata pasticceria 4 ripiani

Pastry stand, 4-tier
Présentoir à pâtisserie 4 étages
Soporte pastelería 4 pisos
Petit Four Ständer 4-fach

	Cm	In	H Cm	In
305 05 42 546	20 x 13,5	7,9 x 3,1	19,5	7,7



Coppa Gelato/Martini

Ice cream/Martini cup
 Coupe à glace/Martini
 Copa helado/Martini
 Eis-/Martini-Schale

	Ø Cm	H Cm	Ø In	H In
335 05 43 640	9,5	9,4	3,3/4	3,3/4
335 05 43 641	9,5	11,5	3,3/4	4,1/2



Portasalatini 3 comparti

Snack holder, 3-bowl Steel
 Service apéritif 3 coupes Acier
 Entremesera 3 boles Acero
 Snackhalter, 3-Schälchen Edelstahl

	H Cm	H In	Ø Cm	Ø In
335 05 41 600	16	6,1/4	8,8	3,3

Coppette non incluse
 Small bowl glass not included

Coppetta vetro

Small bowl, glass
 Petit bo en verre
 Bol pequeño de cristal
 Glasschale

	Ø Cm	Ø In
310 09 04 564	8,5	3,3/8



Portamarmellata 3 comparti

Jam display, 3-bowl Steel
 Porte-confiture 3 coupes Acier
 Dispensador de mermelada 3 boles Acero
 Marmeladendisplay, 3-Schälchen Edelstahl

	H Cm	H in.
335 05 09 572	20	7,7/8



Burriera con coperchio

Butter dish with lid Steel
 Beurrier avec couvercle Acier
 Mantequera con tapa Acero
 Butterdose mit Deckel Edelstahl

	Ø Cm	H Cm	Ø In	H in
335 05 09 570	8	8	3,1/8	3,1/8
335 05 09 571	15	7,5	5,7/8	3



Set spargisale e spargipepe

Salt and pepper shaker set Steel

Set salière et poivrier Acier

Juego salero y pimentero Acero

Salz- und Pfefferstreuer Set Edelstahl

	Ø Cm	H Cm	Ø In	H In.
335 05 12 635	10 x 5	13,5	3,7/8 x 2	5,3/8



Set spargisale, spargipepe e stecchi

Salt, pepper shaker and toothpick holder set Steel

Set salière poivrier porte cure dents Acier

Juego salero pimentero y palillero Acero

Salz-, Pfefferstreuer- und Zahnstocherhalter-Set Edelstahl

	Cm	H Cm	In	H In.
335 05 12 636	10	13,5	3,7/8	5,3/8



Formaggiera

Grated-cheese bowl Steel

Fromagère Parmesan Essenza Acier

Quesera Essenza Acero

Reibekäseschale Edelstahl

	Ø Cm	H Cm	Ø In	H In.
335 05 13 550	9	8	3,1/2	3,1/4



Oliera due posti

Oil and vinegar cruet set, 2-pc Steel

Ménagère deu x pièces Acier

Aceitera dos piezas Acero

Öl- und Essig-Menage-Set, 2-teilig Edelstahl

	Cm	H Cm	In	H In.
335 05 11 630	14,5 x 7,5	23,5	5,3/4 x 3	9,1/4



Essenza

Alzata pasticceria Essenza

Petit four stand Essenza

Plat à petits fours sur pied Essenza

Soporte para pasteles Essenza

Petit Four Essenza

	Ø Cm	H Cm	Ø In	H In
335 05 42 679	12,5	13	4,7/8	5,1/8
335 05 42 680	16,5	13	6,1/2	5,1/8
335 05 42 681	22	13	8,5/8	5,1/8



Alzata pasticceria Essenza doppia

Petit four stand Essenza 2-tier

Plat à petits fours sur pied 2 Essenza étages

Soporte para pasteles Essenza 2 pisos

Petit Four Essenza St. 2-fach

	Ø Cm	H Cm	Ø In	H In
335 05 42 682	12,5/16,5	17	4,7/8 - 6,1/2	6,3/4
335 05 42 683	16,5/22	17	6,1/2 - 8,5/8	6,3/4



Alzata pasticceria Essenza tripla

Petit four stand Essenza 3-tier

Plat à petits fours sur pied 3 Essenza étages

Soporte para pasteles Essenza 3 pisos

Petit Four Essenza St. 3-fach

	Ø Cm	H Cm	Ø In	H In
335 05 42 684	12,5/16,5/22	30	4,7/8-6,1/2-8,5/8	11,3/4



Alzata torta

Cake stand Steel
 Plat à tarte sur pied Acier
 Soporte para pastel Acero
 Kuchenständer Edelstahl

	Ø Cm	H Cm	Ø In	H In
335 05 42 699	22	15	8,5/8	5,7/8
335 05 42 701	22	21	8,5/8	8,1/4



Alzata torta

Cake stand Steel
 Plat à tarte sur pied Acier
 Soporte para pastel Acero
 Kuchenständer Edelstahl

	Ø Cm	H Cm	Ø In	H In
335 05 42 698	32	9	12,5/8	3,1/2
335 05 42 700	32	15	12,5/8	5,7/8



Alzata frutta 3 piani

Essenza fruit stand 3-tier Steel
 Plat à fruits Essenza 3 étages Acier
 Frutero Essenza 3 pisos Acero
 Essenza Obststand 3-stöckig Edelstahl

	Ø Cm	H
335 05 42 703	27 - 32 - 40	48
	Ø In	H In
	10,5/8 - 12,5/8 - 15,3/4	18,7/8



Essenza

Alzata frutta/crostacei tonda Essenza

Fruit/seafood stand Essenza, round

Plat à fruit/crustacés rond Essenza

Soporte fruta/mariscos redondo Essenza

Meeresfrüchtestander Essenza

	Ø Cm	H Cm	Ø In	H In
335 05 42 686	27	15	10,5/8	5,7/8
335 05 42 687	32	15	12,5/8	5,7/8
335 05 42 702	40	15	15,3/4	5,7/8

griglia ghiaccio non è inclusa / rack not included



Alzata frutta/crostacei 2 piani tonda Essenza

Fruit/seafood stand Essenza, 2-tier, round

Plat à fruit/crustacés 2 étages rond Essenza

Soporte fruta/mariscos 2 pisos redondo Essenza

Meeresfrüchtestander Essenza 2-fach.

	Ø Cm	H Cm	Ø In	H In
335 05 42 688	27-32	30	10,5/8-12,5/8	11,3/4

griglia ghiaccio non è inclusa / rack not included



Griglia tonda

Rack, round

Grille ronde

Reja redonda

Gestell, rund

	Ø Cm	Ø In
335 05 72 768 per alzata	27	10,5/8
335 05 72 769 per alzata	32	12 5/8





Essenza

Alzata frutta/crostacei ovale Essenza

Seafood stand Essenza, oval

Plat à crustacés oval Essenza

Soporte mariscos oval Essenza

Meeresfrüchtestander oval Essenza

	Cm	H Cm	In	H In
335 05 42 689	19 x 33	15	7,1/2 x 13	5,7/8
335 05 42 690	24 x 42	15	9,1/2 x 16,1/2	5,7/8

griglia ghiaccio non è inclusa / rack not included



Alzata frutta/crostacei 2 piani ovale Essenza

Fruit/seafood stand Essenza, 2-tier, oval

Plat à fruit/crustacés 2 étages ovale Essenza

Soporte fruta/mariscos 2 pisos oval Essenza

Meeresfrüchtestander Essenza 2-fach.

	Cm	H Cm	In
335 05 42 691	19 x 33 - 24 x 42	30	7,1/2 x 13-9,1/2 x 16,1/2

griglia ghiaccio non è inclusa / rack not included



Griglia ovale

Rack, oval

Grille ovale

Reja oval

Gestell, oval

	Ø Cm	Ø In
335 05 72 767 per alzata	24 x 42	9,1/2 x 16,1/2
335 05 72 766 per alzata	19 x 33	7,1/2 x 13



Portanumero da tavolo, senza tavoletta

Table-number stand Steel without plate
Support numéro de table sans tablette Acier
Soporte número de mesa Acero sin plaquita
Tischnummernständer Edelstahl ohne Platte

	H Cm	H in.
335 05 19 540	40	15,3/4



Tavoletta portanumero tavolo

Transparent plate for table number stand
Tablette transparente pour support numéro de table
Plaquita transparente soporte número de mesa
Transparenter Teller für Tischnummernständer

	Cm	in
● 335 12 19 541	10,5 x 11	4,1/8 x 4,3/8
● 335 12 19 542	10,5 x 11	4,1/8 x 4,3/8



Sottobottiglia

Essenza bottle coaster Steel
Dessous de bouteille Acier Inox
Posa botella Acero
Flaschenuntersetzer Edelstahl

	Ø Cm	Ø in
335 05 21 542	13	4,3/8



Piattino Amuse-bouche

Small Dish Amuse-bouche
Platito Amuse-bouche
Petit plat Amuse-bouche
Schale klein Amuse-bouche

	Ø Cm	Ø in
V39 05 21 001	9	3,1/2



Portagrissini orizzontale

Breadstick holder

Porte-gressins horizontal acier

Contenedor palitos de pan horizontal Acero

Grissinihalter Edelstahl

	Cm	In
335 05 42 696	24 x 6	9,1/2 x 3/4



Portagrissini verticale

Breadstick holder, vertical Steel

Porte-gressins vertical Acier

Contenedor palitos de pan vertical Acero

Grissinihalter, vertikal Edelstahl

	Ø Cm	H Cm	Ø In	H in.
335 05 42 697	5	16	2	6,1/4



Portagrissini verticale

Breadstick holder, vertical Steel

Porte-gressins vertical Acier

Contenedor palitos de pan vertical Acero

Grissinihalter, vertikal Edelstahl

	Ø Cm	H Cm	Ø In	H in.
335 05 42 704	4	15	1,5/8	5,7/8



Cestino pane e frutta tondo con manico in pelle

Round bread basket leather handle
Corbeille à pain rond avec manche en cuir
Cesta pan redonda con asas de piel
Brotkorb rund mit Lederriemen

	Cm Ø	In Ø
305 05 24 596	20	7,7/8



Cestino pane e frutta tondo

Round bread and fruit basket
Corbeille à pain rond
Cesta pan redonda
Brotkorb rund

	Cm Ø	In Ø
305 05 24 599	20	7,7/8



Portatoast per 4 fette

Toast rack, 4-slice
Porte-toast 4 tranches
Portatostadas 4 rebanadas
Toastständer

	Cm	H Cm	In	H In
305 05 71 542	12 x 9,6	15	4,7 x 3,8	5,9



Essenza

Cestino pane/frutta ovale con manico in pelle

Oval bread basket leatherhandle

Corbeille à pain oval manche en cuir

Cesta pan oval asas de piel

Brotkorb oval mit Lederriemen

	Cm Ø	In Ø
305 05 24 597	22,5 x 13	8,7/8 x 5,1/8



Cestino pane/frutta ovale

Oval bread basket

Corbeille à pain oval

Cesta pan oval

Brotkorb oval

	Cm Ø	In Ø
305 05 24 600	22,5 x 13	8,7/8 x 5,1/8



Cesta con maniglie

Bread/fruit basket with handles Steel

Corbeille à pain avec poignées Acier

Cesta pan Essenza con asas Acero

Brot-/Obstkorb mit Griffen Edelstahl

	Cm	In
335 05 24 614	41 x 25	16,1/2 x 9,7/8



Centrotavola ovale Essenza

Centrepiece Essenza, oval
Centre de table oval Essenza
Centro de mesa oval Essenza
Tischdeko oval Essenza

	Cm	H Cm	In	H In
335 05 24 611	19 x 33	5	7,1/2 x 13	5,7/8
335 05 24 612	24 x 42	5	9,1/2 x 16,1/2	5,7/8



Centrotavola tondo Essenza

Centrepiece Essenza, round
Centre de table rond Essenza
Centro de mesa redondo Essenza
Tischdeko Essenza

	Ø Cm	H Cm	Ø In	H In
335 05 24 609	27	5	10,5/8	2
335 05 24 610	32	5	12,5/8	2



Piatto salmone Essenza Legno

Essenza salmon board, wood
Plaetau à saumon Essenza en bois
Fuente salmón Essenza en madera
Essenza Lachsschale aus Holz

	Cm	H Cm	In	H In
335 05 22 705	67 x 20,5	3	26,4 x 8,1	1,2



Essenza

Vassoio Essenza

Tray Essenza
Plateau Essenza
Bandeja Essenza
Tablett Essenza

TONDO - Round

	Ø Cm	In
335 05 23 900	28	11



Vassoio Essenza

Tray Essenza
Plateau Essenza
Bandeja Essenza
Tablett Essenza

OVALE - Oval

	Ø Cm	In
335 05 23 901	40 x 23	15,7 x 9,1
335 05 23 902	49 x 28	19,3 x 11



Vassoio a foglia

Essenza leaf-shaped tray Steel
 Plateau Essenza en forme de feuille Acier
 Bandeja Essenza en forma de hoja Acero
 Essenza blattförmiges Tablett Edelstahl

	Cm	In
305 05 23 890	33 x 20	13 x 7,7/8
305 05 23 891	33 x 25	13 x 9,7/8
305 05 23 892	31 x 23,5	12.2 x 9.25



Cloche

Dome cover inside Steel
 Cloche Essenza Acier
 Cúpula Essenza Acero
 Cloche innen Edelstahl

	Ø Cm int. Ø Cm est.			Ø in int. Ø in ext.
335 05 53 657	18	20,5	7	8
335 05 53 658	22	24	8,5/8	9,1/2
335 05 53 659	24	26	9,1/2	10,1/4
335 05 53 660	28	30	11	11,3/4
335 05 53 661	30	32	11,3/4	12,5/8



Portasalse 4 posizioni

Sauce holder, 4 bowl Steel
 Porte-sauces, 4 coupes Acier
 Porta-salsas, 4 boles Acero
 Saucenhalter, 4-Schälchen Edelstahl

	Lt	H Cm	Oz	H In
335 05 12 640	0,2	18	7,05	7







Secchio champagne Essenza

Champagne bucket Essenza
 Seau à champagnet Essenza
 Champañera Essenza
 Champagnerkühler Essenza

	Ø Cm	H Cm	Ø In	H In
335 05 20 688	20.5	8,1/8	20	7,7/8



Secchio champagne Essenza con pomoli

Champagne bucket with knobs Essenza
 Seau à champagnet avec poignées Essenza
 Champañera con pomos Essenza
 Champagnerkühler mit Knöpfen Essenza

	Ø Cm	H Cm	Ø In	H In
335 05 20 689	20.5	20	8,1/8	7,7/8



Supporto secchio Essenza

Champagne bucket stand
 Support pour seau à champagne
 Soporte para champañera
 Ständer für Champagnerkühler Essenza,

	H Cm	In
335 05 20 683	82	32,1/4



Supporto secchio tondo

Champagne cooler stand, round
 Support rond pour seau à champagne
 Soporte redondo para champañera
 Champagnerkühler Ständer rund

	H Cm	In
V78 05 20 676	57	22,1/2

Raccogli condensa per secchio champagne Essenza

Condensate collection saucer for champagne bucket
 Soucoupe à condensat pour seau à champagne
 Platillo de condensado para champañera
 Kondensatauffanguntersetzer für Sektkübel

	Ø Cm	Ø In
335 05 20 684	16	6,1/4





Secchio champagne 3 bottiglie

Champagne bucket - 3 bottle
Seau à champagnet - 3 bouteilles
Champañera - 3 botellas
Champagnerkühler - 3 Flaschen

	Ø Cm	H Cm	Ø In	H In
335 05 20 692	25	22,5	9,7/8	8,7/8



Secchio 3 bottiglie c/pom.

Champagne bucket with knobs - 3 bottle
Seau à champagnet avec poignées - 3 bouteilles
Champañera con pomos - 3 botellas
Champagnerkühler mit Knöpfen - 3 Flaschen

	Ø Cm	H Cm	Ø In	H In
335 05 20 693	25	22,5	9,7/8	8,7/8



Supporto per secchio 3 bottiglie

Champagne bucket stand - 3 bottle
Support pour seau à champagne - 3 bouteilles
Soporte para champañera - 3 botellas
Ständer für Champagnerkühler - 3 Flaschen

	Ø Cm	H Cm	Ø In	H In
335 05 20 694	23	57,5	9	22,5/8

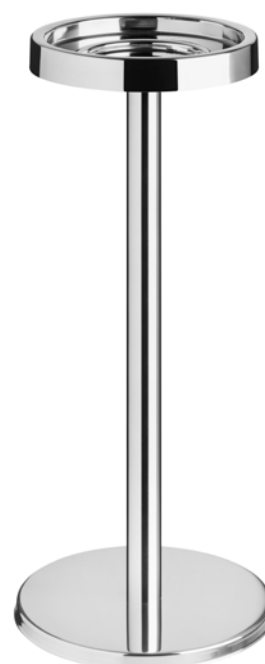





Cube

Secchio champagne Cube doppio corpo

Champagne bucket Cube double-wall

Champañera Cube doble pared

Seau à Champagne Cube double paroi

Champagnerkühler Cube doppelwandig

	Ø Cm	H Cm	Ø In	H In
335 05 20 691	22	22,5	8,5/8	8,7/8



Supporto secchio

Champagne bucket stand

Support pour seau à champagne

Soporte para champañera

Ständer für Champagnerkühler

	H Cm	In
335 05 20 683	82	32,1/4



Supporto secchio tondo

Champagne cooler stand, round

Support rond pour seau à champagne

Soporte redondo para champañera

Ständer für Champagnerkühler rund

	H Cm	In
V78 05 20 676	57	22,1/2

Coppa punch Cube doppio corpo

Punch bowl Cube double-wall
Champañera Cube doble pared
Bol à punch Cube double paroi
Punchschale Cube doppelwandig

	Ø Cm	H Cm	Ø In	H In	Lt	Oz
335 05 43 501	37,8	19,5	15	7,5/8	13	439



Coppone ovale per 8 bottiglie

Champagne bowl, oval, 8-bottle
Bol à champagne oval para 8 bouteilles
Champañera oval para 8 botellas
Champagnerkühler für 8 Flaschen

	Cm	H Cm
335 05 24 607	57 x 52	20,0







Zeta

Acciaio - 18/10 St. Steel



Zeta

Caffettiera

Coffee pot

Cafetière

Cafetera

Kaffeekanne

	Cl	Oz
305 05 01 611	30	10
305 05 01 612	60	20
305 05 01 613	90	30
305 05 01 614	150	53



Cremiera

Creamer

Crémier

Lechera

Milchgießer

	Cl	Oz
305 05 03 621	15	6
305 05 03 622	30	10
305 05 03 623	60	20
305 05 03 624	90	30





Teiera

Teapot
Théière
Tetera
Teekanne

	Cl	Oz
305 05 02 578	40	13,5
305 05 02 579	60	20
305 05 02 580	100	35



Brocca acqua

Water pitcher
Carafe à eau
Jarra agua
Wasserkrug

	Cl	H Cm
305 05 08 544	150	19,5

Porta bustine verticale

Vertical sachet holder
Porte-sachets vertical
Porta sobres vertical
Vertikaler Beutelhalter

	H Cm	H In
305 05 71 976	8,5	3,3/8



Zuccheriera

Sugar bowl
Sucrier
Azucarero
Zuckerdose

	H Cm	H In
305 05 04 584	6,2	2,3/8



Spargisale e spargipepe

Salt and pepper shakers
Salière et poivrier
Salero y pimentero
Salz-und Pfefferstreuer

	H Cm	H In
305 05 12 619	5,2	2
305 05 12 620	5,2	2



Portastecchi

Toothpick holder
Porte cure-dents
Palillero
Zahnstocherhalter

	H Cm	H In
305 05 11 621	5,2	2



Portabustine zucchero/tè

Sugar/tea bag holder
Porte-sachets de thé/sucre
Porta sobres de té/azúcar
Zucker/Teebeuteln

	Cm	H Cm	In	H In
305 05 04 585	11,8 x 6,3	4,0	4,4/3 x 2,1/2	1,1/2



Burriera

Butter dish
Beurrier
Mantequera
Butterdose

	Ø Cm	H Cm	Ø In	H In
305 05 09 561	10,5	7,6	4,1/8	3



Coppa multiuso

Multipurpose bowl
Coupe multi-usage
Bol multiuso
Universalschale

	Cm	H Cm	In	H In
305 05 43 614	13 x 10	5,3	5,1/8 x 4	2,1/8



Salsiera doppio becco

Double-spout sauce boat
Saucière à double bec
Salsera doble pico
Sauciere Ausguß beids

	Cm	H Cm	In	H In
305 05 12 624	16 x 10	5,4	6,1/4 x 4	2,1/8



Servitore tè/pasticceria acciaio inox

Afternoon-tea stand
Support pour service à thé
Soporte e x positor platos postrre
Teller-Etagere

	Cm	H Cm
305 05 42 598 per piatti/for dishes Ø Cm 25	30	40
305 05 42 599 per piatti/for dishes Ø Cm 30	31,4	41,1



Portavasetti marmellata

4-jar jam holder
Porte-confiture pour 4 pots
Dispensador de mermelada para 4 botes
Konfitüreschale 4-tlg

	Ø Cm (foro)	Ø In (foro)
305 05 09 562	4,5	1,3/4
305 05 09 563	5,8	2,3/8



Lampada da tavolo

Table lamp
Lampe à bougie
Lámpara de mesa
Tischlampe

	H Cm	H In	
305 05 17 532	16	6,1/4	Clear
305 05 17 535	16	6,1/4	Grey



Candeliera 1 luce

Candlestick, 1-light
Flambeau 1 lumière
Candelero 1 luz
1-armig, Leuchter

	H Cm	H In
305 05 18 560	15,5	6,1/8



Candelabro 3 luci

Candelabrum, 3-light
Candélabre 3 lumières
Candelabro 3 luces
3-armig, Kerzenleuchter

	H Cm	H In
305 05 18 561	46,5	18,1/4



Candelabro 5 luci

Candelabrum, 5-light
Candélabre 5 lumières
Candelabro 5 luces
5-armig, Kerzenleuchter

	H Cm	H In
305 05 18 562	46,5	18,1/4





Vassoio con portabustine

Tray with sugar/tea bag holder
 Plateau avec porte-sachets thé/sucre
 Bandeja con porta sobres de tè/azucar
 Tablett mit Zuck./Teebeuteln

	Cm	In
305 05 04 586	21 x 13,5	8,1/4 x 5,3/8

Vassoio accessori colazione

Breakfast accessories tray
 Plateau accessoires à petit déjeuner
 Bandeja accesorios desayuno
 Tablett mit Frühstückzubehör

	Cm	In
305 05 23 823	21 x 13,5	8,1/4 x 5,3/8



Vassoio rendiresto

Change tray
 Plateau porte-monnaie
 Bandeja portamoneda
 Geldwechsellablett

	Cm	In
305 05 23 809	21 x 13,5	8,1/4 x 5,3/8





Cestino pane ovale ad anelli

Ring oval bread basket
Corbeille à pain à anneau x
Cesta pan aros
Brotkorb

	Cm	In
305 05 24 566	16,2 x 12,7	6,1/4 x 5

Barchetta gourmet

Gourmet boat
Corbeille à pain gourmet
Cesta pan gourmet
Gourmetschale

	Cm
305 05 24 561	33 x 10

In
13,4



Cestino pane

Bread basket
Corbeille à pain
Cesta pan
Brotkorb

	Cm	In
305 05 24 560	30 x 16	11,3/4 x 6,1/4

Glacette

Glacette
Rafraîchisseur de bouteille
Enfriador de botellas
Weinkühler

	Cm	H Cm	In	H In
305 05 24 559	14,5 x 10,5	H 22	5,3/4 x 4,1/8	8,5/8



Secchio ghiaccio

Ice bucket
Seau à glace
Cubo hielo
Eiswürfelbehälter

	Cm	H Cm	In	H In
305 05 20 667	16 x 12,5	16,5	6,1/4 x 5	6,1/2



Secchio champagne

Champagne bucket
Seau à champagne
Champañera
Sektkühler

	Cm	H Cm	In	H In
305 05 20 666	19 x 15	19,5	7,1/2 x 6	7,5/8







Colonna secchio champagne

Champagne bucket stand
Support pour seau à champagne
Soporte champañera
Sektkühlerständer

	H Cm	H In
305 05 20 668	59,5	23,1/2

Secchio champagne

Champagne bucket
Seau à champagne
 Champañera
 Sektkühler

	Cm	H Cm	In	H In
305 05 20 666	19 x 15	19,5	7,1/2 x 6	7,5/8



Supporto secchio da tavolo ovale

Table champagne-bucket stand St.Steel
Support pour seau champagne de table Acier Inox
 Soporte para champañera para mesa Acero Inox
 Tischhalterung für Champagnerkühler, Edelstahl

	Cm	H Cm	In	H In
335 05 20 686	17 x 22	11	6,7 x 8,7	4,3





Decò
Acciaio - 18/10 St. Steel



Caffettiera

Coffee pot
Cafetière
Cafetera
Kaffeekanne

	Cl	Oz
335 05 01 618	35	12
335 05 01 619	60	21
335 05 01 620	90	30,4
335 05 01 621	150	50



Teiera

Teapot
Theière
Tetera
Teekanne

	Cl	Oz
335 05 02 581	35	12
335 05 02 582	60	21
335 05 02 583	90	30,4



Zuccheriera

Sugar bowl
Sucrier
Azucarero
Zuckerdose

	Gr	Oz
335 05 04 001	250	8,75



Cremiera

Creamer
Crémier
Jarrita de leche
Milchgießer

	Cl	Oz
335 05 03 626	15	5



Lattiera

Milk pot
Pot à lait
Lechera
Milchkanne

	Cl	Oz
335 05 03 627	35	12
335 05 03 628	60	21



Brocca acqua

Water jug
Carafe à eau
Jarra agua
Wasserkrug

	Cl	Oz
335 05 08 561	150	50





Veneto/Iseo

Acciaio - 18/10 St. Steel



Stainless steel hollowware manufacturing process

To make an Iseo coffee pot the first step is to shear the disk (1), that is, a disk of a suitable diameter is cut out of a stainless steel sheet. By means of a die the body is drawn first (2) to get the cylindrical body of the coffee pot; afterwards small spout is flared (3). Once the body is ready, the handle is welded (4). Once the lid is drawn (5), the knob is braze-welded (6) and the lid is coupled to the body with a pin (7). Now the coffee pot is finished. The process ends when the coffee pot is polished (8).

Cycle de production vaisselle en acier inox

Par la réalisation d'une cafetière Iseo, on part du découpage du disque (1), où, à partir de la tôle, on découpe un disque du diamètre opportun en acier inox. Moyennant un moule, on commence d'abord par l'emboutissage du corps (2) jusqu'à l'obtention du corps cylindrique de la cafetière, et ensuite on procède à la réalisation du bec verseur moyennant évasement (3). Une fois que le corps a été obtenu, on procède à la soudure du manche (4). Après l'emboutissage du couvercle (5), on procède au soudo-brasage du pommeau (6) et au montage au goujon du couvercle au corps (7). À ce point-là, cafetière est complète : la réalisation se termine par le polissage de l'objet (8).

Ciclo de producción de vajilla de acero inox idable

Para la realización de una cafetera Iseo se comienza por el troquelado del disco (1), con el que en la chapa se corta un disco de acero inox idable del diámetro oportuno. Mediante un molde se procede primero a la embutición del cuerpo (2) hasta obtener el cuerpo cilíndrico de la cafetera, y luego se procede a la realización del pico mediante abocinamiento (3). Una vez obtenido el cuerpo, se procede a la soldadura del mango (4). Después de la embutición de la tapa (5), se procede a la bronzesoldadura del pómulo (6) y al montaje con perno de la tapa al cuerpo (7). A estas alturas la cafetera está completa: la elaboración termina con el abrillantado del objeto (8).

Produktionszyklus von geschirr aus rostfreiem stah

Bei der Anfertigung einer Iseo Kaffeekanne startet man mit dem Schnitt der Scheibe (1), d.h. aus dem Stahlblech wird eine Scheibe von geeignetem Durchmesser ausgeschnitten. Mit Hilfe eines Gesenks erfolgt dann das Tiefziehen des Körpers (2) bis man den Hohlkörper der Kanne erhält, danach wird der Hahn durch Ansenken geformt (3) An dem so erhaltenen Körper wird der Griff durch Weichlöten (4) angebracht. Nach Tiefziehen des Deckels (5) wird der Knauf durch Hartlöten angebracht (6) und der Zapfen an Deckel und Körper montiert (7). Jetzt ist die Kaffeekanne fertig und man beginnt mit dem Polieren des Gegenstandes (8).

Acciaio

Fasi di lavorazione

Per la realizzazione di una caffettiera Iseo si parte

dalla tranciatura del disco (1), dove dalla lamiera si va a tranciare un disco del diametro opportuno in acciaio inox. Mediante uno stampo si procede prima con l'imbutitura del corpo (2) fino ad ottenere il corpo cilindrico della caffettiera, e poi si procede con la realizzazione del nasello tramite slabatura (3). Una volta ottenuto il corpo, si procede con la saldatura del manico (4). Dopo l'imbutitura del coperchio (5), si procede con la saldobrasatura del pomolo (6) e con il montaggio con perno del coperchio al corpo (7). A questo punto la caffettiera è completa: la lavorazione termina con la lucidatura dell'oggetto (8).

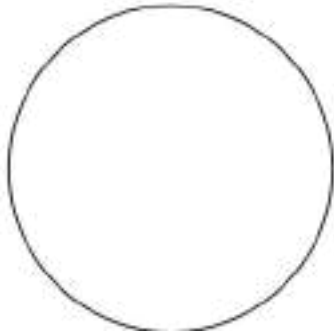

1

Tranciatura disco
Shearing



2

Imbutitura
Drawing

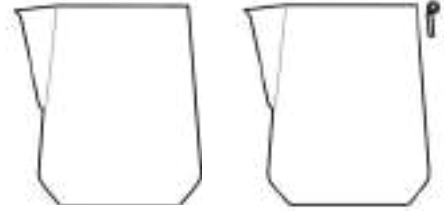

3

Slabratura
Flaring

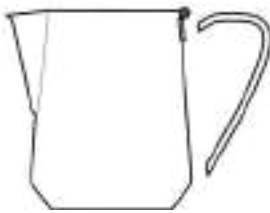

4

Saldatura manico
Handle welding



5

Imbutitura coperchio
Lid drawing



6

Saldobrasatura pomolo
Knob braze-welding



7

Montaggio perno e coperchio
Knob and lid assembly



8

Lucidatura
Polishing

Veneto

Caffettiera Veneto

Veneto coffee pot
Cafetière Veneto
Cafetera Veneto
Kafeekanne Veneto

	Lt	Oz
305 05 01 593	0,35	12
305 05 01 592	0,60	21
305 05 01 594	0,90	31,5
305 05 01 595	1,50	53



Teiera Veneto

Veneto teapot
Theière Veneto
Tetera Veneto
Teekanne Veneto

	Lt	Oz
305 05 02 560	0,35	12
305 05 02 561	0,55	19
305 05 02 562	0,88	31,3



Zuccheriera con coperchio e manici Veneto

Veneto sugar bowl with cover and handles
Sucrier avec couvercle et anses Veneto
Azucarero con tapa y asas Veneto
Zuckerdose mit Deckel und Griffen Veneto

	Gr	Oz
305 05 04 572	360	12,7



Zuccheriera con coperchio senza manici Veneto

Veneto sugar bowl without cover and handles
Azucarero sin tapa y asas Veneto
Sucrier sans couvercle et anses Veneto
Zuckerdose ohne Deckel und Griffen Veneto

	Gr	Oz
305 05 04 601	250	8,75



Cremiera / lattiera

Veneto creamer / milk pot / water pitcher
Crémier / pot à lait / carafe à eau Veneto
Jarrita de leche / lechera / jarra agua Veneto
GießBer / Wasserkrug Venet

	Lt	Oz
305 05 03 598	0,15	5



Cremiera / lattiera / brocca acqua veneto

Veneto creamer / milk pot / water pitcher
Crémier / pot à lait / carafe à eau Veneto
Jarrita de leche / lechera / jarra agua Veneto
GießBer / Wasserkrug Venet

	Lt	Oz
305 05 03 599	0,35	12
305 05 03 600	0,60	21
305 05 03 601	0,90	31,5
305 05 03 602	1,50	53



Brocca acqua

Water pitcher
Carafe à eau
Jarra agua
Wasserkrug

	Lt	Oz
305 05 08 527	1,50	53



Caraffa termica conica

Insulated beverage server

Pot isotherme

Jarra térmica

Thermische Karaffe

	Lt	Oz
305 05 08 557	0,30	10
305 05 08 558	0,60	21
305 05 08 559	1,00	35
305 05 08 560	1,50	53



Caraffa termica cilindrica

Insulated beverage server

Pot isotherme

Jarra térmica

Termische Karaffe

	Lt	Oz
305 05 08 540	0,60	21
305 05 08 541	1,00	35
305 05 08 542	1,50	53



Portasalatini

Snack holder

Service apéritif

Entremesera

Salzgebäckschale

		Ø Cm	Ø In
305 05 41 554	3 comparti - 3 bowls	8,5	3,3/8
305 05 41 556	4 comparti - 4 bowls	8,5	3,3/8
310 09 04 564	Coppetta vetro - Glass bowl	8,5	3,3/8



Alzata piccola pasticceria

Petits fours stand
 Plat à petits fours sur pied
 Soporte pastas de té
 Petits-Fours-Ständer

	Ø Cm	H Cm	Ø In	H In
305 05 41 512	16	17	6,1/4	6,3/4



Alzata piccola pasticceria 2/3 piani

Petits fours stand, 2/3 tier
 Plat à petits fours sur pied, 2/3 étages
 Soporte pastas de té 2/3 pisos
 Petits-Fours-Ständer, 2/3 stufig

		Ø Cm	H Cm	Ø In	H In
305 05 41 516	2 piani - 2 tier	16-22	24	6,1/4-8,5/8	9,1/2
305 05 41 517	3 piani - 3 tier	16-22-26	39	6,1/4-8,5/8-10,1/4	15,3/8



Alzata pasticceria / portamarmellata 3 piani

Pastry stand / jam dish, 3 - tier
 Presentoir pâtissier / porte - confiture, 3 étages
 Soporte pastas de té / dispensador de mermelada, 3 pisos
 Kuchenständer / konfitüreschale, 3 stufig

	Ø Cm	H Cm	Ø In	H In
305 05 41 578	26 - 32 - 38	40	10,1/4-12,5/8-15	15,3/8



Alzata torta

Cake stand
Présentoir à gâteau x
Soporte pastel
Tortenplatte

	Ø Cm	Ø In
305 05 42 516	22	8,5/8
305 05 42 517	32	12,5/8
305 05 42 518	42	16,1/2



Alzata frutta

Fruit stand
Plat à fruits sur pied
Frutero
Obstständer

	Ø Cm	Ø In
305 05 42 520	22	8,5/8
305 05 42 521	29	11,1/2
305 05 42 522	36,5	14,3/8



Portamarmellata con vaso fiori

Jam display with flower vase
Présentoir à confiture avec vase à fleurs
Soporte mermeladas con florero
Konfitüreschale - Display

	H Cm	H In
305 05 09 511	21,5	8,1/2

5 compartì - 5 dishes



Portamarmellata

Jam display
Présentoir à confiture
Soporte mermeladas
Konfitüreschale - Display

	H Cm	H In
305 05 09 530	14	5,1/2

3 compartì - 3 dishes



Alzata frutta 3 piani

Fruit stand, 3 - tier
Plat à fruits sur pied, 3 étages
Frutero, 3 pisos
Obststände, 3 stufig

	Ø Cm	H Cm	Ø In	H In
305 05 42 523	22 - 29 - 36,5	50	8,5/8 - 11,1/2 - 14,3/8	19,3/4



Alzata torta nuziale

Wedding cake stand
Presentoir à gâteau x de mariage
Soporte tarta nupcial
Hochzeitstortenplatte

	Ø Cm	H Cm	Ø In	H In
305 05 42 519	22 - 32 - 42	54	8,5/8 - 12,5/8 - 16,1/2	21,1/4



Oliera 2 posti

Oil & vinegar cruet, 2 - piece
Ménagère, 2 pièces
Juego aceitera vinagnero, 2 piezas
Essig-/ Ölgestell, 2-tlg

	Cm	H Cm	In	H In
305 05 11 533	14 x 7	22	5,1/2 x 2,3/4	8,5/8



Set spargisale, spargipepe e portastecchi

Salt shaker, pepper shaker and toothpick holder set
Set salière, poivrier et porte cure-dents
Set salero, pimentero y palillero
Menage Komplet

	Cm	H Cm	In	H In
305 05 12 557	10	13	4	5,1/8



Set spargisale e spargipepe

Salt shaker and pepper shaker set
Set salière et poivrier
Set salero y pimentero
Salz / Pfefferstreuer set

	Cm	H Cm	In	H In
305 05 12 558	10 x 5	13	4 x 2	5,1/8



Spargisale - spargipepe

Salt and pepper shakers
Salière et poivrière
Salero y pimentero
Salz/Pfefferstreuer

	Cm	In
Spargisale - Salt shaker		
305 05 12 502	8	3,1/8
Spargipepe - Pepper shaker		
305 05 12 503	8	3,1/8



Tavoletta serigrafata in metacrilato

Small plate, methacrylate

Plaque en méthacrylate

Plaquita de metacrilato

Plaxiglas Schild fuer Produktinfo

	H Cm	H In
305 12 19 525	12 x 18	4,3/4 x 7



Portanumero da tavola

Table number stand

Support numéro de table

Soporte número de mesa

Tischnummerständer

	H Cm	H In
305 05 19 524	30	11,3/4



Sottocoppa / vassoietto

Underliner / small round tray

Dessous de coupe / petit plateau rond

Posa vaso / bandejita redonda

Untersatz / Tablettchen

	Ø Cm	Ø In
305 05 21 513	12	4,3/4
305 05 21 514	14	5,1/2
305 05 23 561	16	6,1/4
305 05 23 562	20	7,7/8
305 05 23 563	22	8,5/8



Formaggiera con pomolo

Grated cheese bowl with knob

Fromagère avec pommeau

Quesera con pomo

Käsedose

	Ø Cm	Ø In
305 05 13 536	9	3,1/2



Formaggiera con coperchio a cerniera

Grated cheese bowl with hinged cover

Fromagère avec couvercle à charnière

Quesera con tapa con bisagra

Käsedose

	Ø Cm	Ø In
305 05 13 502	9	3,1/2



Coppa macedonia

Fruit salad cup

Coupe à dessert

Fuente para macedonia de frutas

Obstsalatschale

	Ø Cm	Ø In
305 05 43 536	12	4,3/4



Coppa multuso / lavadita

Multipurpose bowl / fingerbowl

Coupe multi-usage / rince-doigts

Bol multuso / lavadedos

Universalschale / Fingerschale

	Ø Cm	Ø In
305 05 43 537	12	4,3/4



Piattino

Underliner

Dessous de coupe

Platito posacopa

Untersatz

	Ø Cm	Ø In
305 05 21 513	12	4,3/4



Coppa supreme

Supreme cup - Coupe à suprême
Copa supreme - Schale Supreme

	Ø Cm	Ø In
305 05 43 546	13	5,1/8



Coppetta interna acciaio inossidabile

Stainless steel inside cup - Coupe intérieure en acier inox idable
Coppita interior en acero inox idable - Schale, Edelstahl rostfrei

	Ø Cm	Ø In
305 05 43 541	9	3,1/2



Coppetta interna cristallo

Crystal inside cup - Coupe intérieure en cristal
Bol pequeño interior en cristal - Schale, kristall

	Ø Cm	Ø In
305 08 43 545	10	4



Anello adattatore

Adjusting ring - Bague de réglage
Anillo adaptador - Einsatzring

	Ø Cm	Ø In
305 05 43 540	10,5	4,1/8



Coppa esterna base

Outside base cup - Coupe base e x térieure
Copa e x terior base - Schale auf Fuß

	Ø Cm	Ø In
305 05 43 539	13	5,1/8



Piattino portaburro

Butter dish - Coupe à beurre
Mantequera - Butterschale

	Ø Cm	Ø In
305 05 22 648	9	3,1/2



Griglia portaburro

Butter grid - Plat à beurre perforé
Parrilla para mantequera - Buttergitter

	Ø Cm	Ø In
305 05 72 539	9	3,1/2





Piatto presentazione decoro inglese

Show plate, English decoration

Plat de présentation, decor anglais

Plato de presentación, decoración inglesa

Platzteller, Dekor English

	Ø Cm	Ø In
305 05 25 533	31,5	12,3/8
305 05 25 562	33	13



Piatto presentazione a falda larga

Show plate, wide rim
Plat de présentation à aile large
Plato de presentación con ala amplia
Platzteller

	Ø Cm	Ø In
305 05 25 513	32	12,5/8



Piatto presentazione leggero bordo rivoltato

Light show plate, turned edge
Plat de présentation léger, bord retourné
Plato de presentación ligero, borde revuelto
Platzteller

	Ø Cm	Ø In
305 05 25 524	31	12,5/8

Coppa caviale

Caviar cup
Coupe à caviar
Copa caviar
Caviarkühler

	Ø Cm	Ø In
305 09 43 563	20/11	7,7/8 / 4,3/8



Supporto frutti di mare con piatto

Oyster tray stand with tray
Support fruits de mer avec plateau
Soporte para mariscos con fuente
Meerfrüchteplatte

		Ø Cm	Ø In
305 05 20 540	Supporto - Stand	27-34	10,5/8-13,3/8
305 05 20 638	Completo - Complete	32	12,5/8
305 05 20 639	Completo - Complete	38	15



Coppa gelato

Ice cream cup
Coupe à glace
Copa helado
Eisschale

	Ø Cm	Ø In	H Cm	H In
305 05 43 627	10,5	4,1/8	9,5	3,3/4



Coppa cocktail scampi

Shrimp cocktail cup
Coupe à cocktail de crevettes
Copa para cóctel de mariscos
Hummer Cocktailschale

	Ø Cm	Ø In
305 05 43 630	11	4,3/8



Coppa gelato

Ice cream cup
Coupe à glace
Copa helado
Speiseeisschale

	Ø Cm	H Cm	Ø In	H In
305 05 43 628	9	10	3,1/2	3,7/8



Piatto lumache a 6/12 fori

Snail dish, 6/12 - hole
Plat à escargots, 6/12 places
Plato caracoles, 6/12 unidades
Schneckenplatte, 6/12 Löcher

	Ø Cm	Ø In
305 05 22 633 (6)	26	10,1/4
305 05 22 634 (12)	32	12,5/8



Salsiera Decò

Decò Sauce boat
Saucière Decò
Salsera Decò
Sauciere Decò

	Cl	Oz
335 05 12 001	15	5,1
335 05 12 002	23	7,8



Salsiera Veneto

Veneto sauce boat
Saucière Veneto
Salsera Veneto
Sauciere Veneto

	Cl	Oz
305 05 12 598	15	5,1
305 05 12 599	23	7,8
305 05 12 600	44	14,9



Burriera

Butter dish
Beurrier
Mantequera
Butterschale

	Ø Cm	Ø In
305 05 09 523	7	2,3/4



Cestino pane gourmet

Oval bread basket St.Steel
 Corbeille à pain Gourmet
 Cesta pan Gourmet
 Gourmet Brotkorb

	Cm	H Cm
305 05 24 613	25 x 15	4



Cestini pane / frutta

Bread / fruit basket
 Corbeille à pain / fruits
 Cesta pan / fruta
 Brot / Obstkorb

	Ø Cm	Ø In
305 05 24 505	19	7,1/2
305 05 24 506	23	9



Cestino pane ovale

Oval bread basket
 Corbeille à pain ovale
 Cesta pan/fruta oval
 Brotkorb oval

	Cm	In
305 05 24 507	27 x 19	10,5/8 x 7,1/2



Cestini pane / frutta

Bread / fruit basket
 Corbeille à pain / fruits
 Cesta pan / fruta
 Brot / Obstkorb

	Ø Cm	Ø In
305 05 24 503	19	7,1/2
305 05 24 504	23	9



Cloche

Dome cover
 Cloche
 Campana
 Cloche

	Ø Cm Int.	Ø Cm Est.	Ø In Int.	Ø In est.
305 05 53 554	18	20,5	7	8
305 05 53 555	22	24	8,5/8	9,1/2
305 05 53 556	24	26	9,1/2	10,1/4
305 05 53 562	28	30	11	11,3/4
305 05 53 569	30	32	11,3/4	12,5/8



Coperchio

Cover
 Cover
 Cover
 Cover

	Ø Cm Int	Ø In Int.
305 05 15 714	14	5,1/2
305 05 15 715	18	7
305 05 15 716	24	9,1/2
305 05 15 717	28	11



Zuppiera

Soup tureen
 Soupière
 Sopera
 Suppenschüssel

	Ø Cm Int	Ø In Int.
305 05 15 706	14	5,1/2
305 05 15 707	18	7
305 05 15 708	24	9,1/2
305 05 15 709	28	11



Legumiera

Vegetable dish
 Légumier
 Legumbrera
 Gemüseschüssel

	Ø Cm Int	Ø In Int.
305 05 15 710	14	5,1/2
305 05 15 711	18	7
305 05 15 712	24	9,1/2
305 05 15 713	28	11



Glacette doppio corpo Wine & Bar

Double-wall bottle cooler

Rafrâchisseur à bouteille double paroi Wine & Bar

Enfriador de botella doble pared Wine & Bar

Weinkühler

	Ø Cm	H Cm	Ø In	H In
V78 05 24 014	13	21	5,1/8	8,1/4



Secchiello ghiaccio e secchio champagne

Ice bucket and champagne bucket

Seau à glace et seau à Champagne

Cubo hielo y champañera

Eis / Sektkühler

	Ø Cm	H Cm	Ø In	H In
305 05 20 541	13	13	5,1/8	5,1/8
305 05 20 542	21	20	8,1/4	7,7/8



Supporto glacette Wine & Bar

Wine & Bar bottle cooler stand
Support pour rafraîchisseur à bouteille Wine & Bar
Soporte para enfriador de botella Wine & Bar
Wine & Bar Weinkühler-Ständer

	H Cm	H In
V01 05 20 676	61	24



Supporto secchio champagne Iseo

Iseo champagne bucket stand
Support pour seau à champagne Iseo
Soporte para champañera Iseo
Iseo Weinkühlerständer

	H Cm	H In
305 05 20 535	62	24 3/8





Secchio champagne ovale

Modern champagne cooler, oval
Seau à champagne ovale Modern
Champañera oval Modern
Modern oval Champagnekühler

	Ø Cm	H Cm	Ø In	H In
305 05 20 681	27	21,5	10,5/8	8,5/1



Supporto secchio ovale

Champagne bucket stand, oval
Support pour seau à champagne
Soporte champañera
Sektkühlerständer

	H Cm	H In
305 05 20 668	59,5	23,1/2



Supporto secchio ovale da tavolo

Table-wine bucket stand, oval
Support de table pour seau
Soporte champañera de mesa
Sektkühlerständer

	Cm	H Cm	In	H In
335 05 20 686	17 x 22	11	6,3/4 x 8,5/8	4,3/8



Secchio champagne tondo Modern

Modern champagne cooler, round
Seau à champagne Modern rond
Champañera Modern redonda
Modern Champagnekühler rund

	Ø Cm	H Cm	Ø In	H In
305 05 20 002	24	22	9,1/2	8,5/8



Supporto secchio tondo Modern

Modern champagne cooler stand, round
Support rond pour seau à champagne Modern
Soporte redondo para champañera Modern
Modern Champagnekühler Ständer rund

	Cm	In
V78 05 20 676	57	22,1/2



Reggisecchio da tavolo

Champagne bucket table stand
Support de table pour seau à champagne
Soporte de mesa para cubo champán
Tischweinkühler

	Ø Cm	Ø In
305 05 20 561	20	7,7/8



Secchiello ghiaccio e glacette doppio corpo Modern

Modern ice bucket and double-wall bottle cooler
Seau à glace et rafraîchisseur à bouteille double paroi Modern
Cubo hielo y enfriador de botella doble pared Modern
Modern Eiswürfelbehälter und Weinkühler

	Ø Cm	H Cm	Ø In	H In
V78 05 20 001 1401	15,3	17	6	15,3
V78 05 24 010 1401	12	19,5	4,7	7,6



Coppa champagne

Champagne bottle bowl
Bol à champagne
Champañera
Champagne Schale

	Lt	Ø Cm	Ø In
V77 05 52 PUN 3	25	53	20,7/8



Coppa punch doppio corpo

Punch bowl, double-wall
Bol à punch double paroi
Champañera doble pared
Champagne Schale

	Lt	Ø Cm	Ø In
V77 05 52 PUN 2	10	39	15,3/8



Coppa punch

Punch bowl
Bol à punch
Champañera
Punchschale

	Lt	Ø Cm	Ø In
305 05 43 543	13	40	15,3/4
305 05 43 575	30	50	19,3/4



Anello portabottiglie per coppa punch Ø 40 Cm

Bottle adapter ring for Ø 40 Cm punch bowl
Anneau porte-bouteilles pour bol a punch Ø 40 Cm
Anillo para botellas champacera Ø 40 Cm
Ring Flaschenhalter fuer Punchschale Ø 40 Cm

	Ø Cm	Ø In
305 05 43 544	30	11,3/4



Inserto in metacrilato per coppa punch Ø 40

Acrylic bowl for punch bowl Ø 40
Bol acrylique pour bol à punch Ø 40
Copa acrilica para champañera Ø 40
Innere Acrylschale Ø 40

		Ø Cm	Ø In
❶	Coperchio - Cover 305 12 43 566	35	13,3/4
❷	Inserto - Bowl 305 12 43 564	33	13
❸	Anello adattatore - Adjusting ring 305 05 43 565	33	13
❹	Mestolo punch - Punch ladle CSV 66		



Portatovaglioli

Napkin holder
 Porte-serviettes
 Servilletero
 Serviettenhalter

	L Cm	H Cm	L In	H In
305 05 71 938	11	9	4,3/8	3,1/2



Portatovaglioli antivento

Windproof napkin holder
 Porte-serviettes coupe-vent
 Servilletero anti viento
 Serviettenhalter Windschutz

	Cm	In	H Cm	H In
305 05 71 983	10 x 10	3,7/8 x 3,7/8	3	1,1/8
305 05 71 988	12,5 x 12,5	4,7/8 x 4,7/8	4	1,5/8
305 05 71 989	16 x 16	6,1/4 x 6,1/4	4	1,5/8



Portatovaglioli quadrato

Square napkin holder
 Porte serviettes carré
 Servilletero quadrado
 Viereckiger Serviettenhalter

	Cm	H Cm	In	H In
V01 05 71 190	19 x 19	7	7,1/2 x 7,1/2	2,3/4



Portatovaglioli Square

Napkin holder
 Porte-serviettes
 Servilletero
 Serviettenhalter

	Cm	H Cm	In	H In
V76 05 71 001	11 x 4	2	4,3/8 x 1,2/3	3,1/8



Portabustine di zucchero / the

Sugar / tea bag holder
 Porte-sachets de sucre / thé
 Porta sobres de azúcar / té
 Zucker - Teeehälter

	Cm	H Cm	In	H In
V78 05 04 PBU	10 x 6,5	3,5	3,9 x 2,6	1,4



Contentitore per noccioli olive

Olive stone holder
 Conteneur pour noyau x d'olives
 Contenedor para nuegos de aceitunas
 Oliven Keimbehälter

	Cm	H Cm	In	H In
305 05 04 591	5 x 5	3	2 x 2	1,2
305 05 41 596	7 x 7	6,5	2,8 x 2,8	2,6



Vassoio con portabustine

Tray with sugar-bag holders
 Plateau avec sucriers
 Bandeja con azucareros
 Tablett mit Zuckerbehälter

	Cm	In
305 05 23 877	26 x 14	10,1/4 x 5,1/2



Vassoio rendiresto

Small change tray
 Plateau porte-monnaie
 Bandeja portamoneda
 Geldplatte

	Cm	In
305 05 23 876	26 x 12	10,1/4 x 5,1/2



Padella flambé

Flambé pan
Poêle à flamber
Sartén para flambear
Flambierpfanne

	Ø Cm	Ø In
305 05 72 543	30	11,3/4



Fornello flambé a gas acciaio

Flambé burner, gas, stainless steel
Réchaud à flamber, gaz
Calentador para flambear, gas
Flambierrechaud / Gaskocher

	H Cm	H In
305 05 52 625	26	10,1/4



Fornello flambé gas ramato

Flambé burner, alcohol, copper plated
Réchaud à flamber, alcool, cuivré
Calentador para flambear, alcohol
Flambierrechaud / Spirituskocher

	H Cm	H In
305 10 52 625	26	10,1/4

Vassoio rettangolare con maniglie

Rectangular tray with handles

Plateau rectangulaire avec anses

Bandeja rectangular con asas

Austellplatte, rechteckig mit Griffen

	Cm	In
305 05 23 572	27 x 21	10,5/8 x 8,1/4
305 05 23 575	35 x 28	13,3/4 x 11
305 05 23 573	40 x 32	15,3/4 x 12,5/8
305 05 23 574	50 x 38	19,3/4 x 15



Vassoio rettangolare

Rectangular tray

Plateau rectangulaire

Bandeja rectangular

Austellplatte, rechteckig

	Cm	In
305 05 23 568	27 x 21	10,5/8 x 8,1/4
305 05 23 571	35 x 28	13,3/4 x 11
305 05 23 569	40 x 32	15,3/4 x 12,5/8
305 05 23 570	50 x 38	19,3/4 x 15



Vassoio tondo bar con maniglie

Round bar tray with handles

Plateau rond bar avec anses

Bandeja redonda bar con asas

Austellplatte mit Griffen

	Ø Cm	Ø In
305 05 23 566	32	12,5/8
305 05 23 567	38	15
305 05 23 775	46	18,1/8
305 05 23 776	54	21,1/4



Vassoio tondo bar

Round bar tray
Plateau rond bar
Bandeja redonda bar
Austellplatte

	Ø Cm	Ø In
305 05 23 564	32	12,5/8
305 05 23 565	38	15
305 05 23 774	46	18,1/8
305 05 23 734	54	21,1/4



Tappetino antiscivolo per vassoio tondo

Non-slip mat for round tray
Tapis antidérapant pour plateau
Alfombrilla antideslizante para bandeja
Rutschfeste Matte

	Ø Cm	Ø In
305 12 27 501	32	12,5/8
305 12 27 502	38	15



Vassoio rettangolare gastronorm

Gastronorm rectangular tray
Plateau rectangulaire gastronorme
Bandeja rectangular gastronorm
Gastronorm Tablett, rechteckig

	Cm	In
V01 05 23 G12	26,5 x 32,5 (1/2)	10,3/8 x 12,3/4
V01 05 23 G11	53 x 32,5 (1/1)	20,7/8 x 12,3/4
V01 05 23 G21	65 x 53 (2/1)	25,5/8 x 20,7/8



Vassoio rettangolare gastronorm con maniglie

Gastronorm rectangular tray with handles
Plateau rectangulaire gastronorme avec poignées
Bandeja rectangular gastronorm con asas
Gastronorm Tablett, mit Griffen - rechteckig

	Cm	In
V01 05 23 G11 M	53 x 32,5 (1/1)	20,7/8 x 12,3/4
V01 05 23 G21 M	65 x 53 (2/1)	25,5/8 x 20,7/8





Vassoio bar rettangolare

Rectangular bar tray - Plateau bar rectangulaire

Bandeja bar rectangular - Austellplatte, rechteckig

	Cm	In
305 05 23 690	30 x 24	11,3/4 x 9,1/2
305 05 23 691	35 x 29	13,2/4 x 11,1/2
305 05 23 692	40 x 31	15,3/4 x 12,1/4
305 05 23 693	45 x 35	17,3/4 x 13,2/4
305 05 23 694	52 x 40	20,1/2 x 15,3/4
305 05 23 695	62 x 48	24,3/8 x 19

Con maniglie - With handles

	Cm	In
305 05 23 696	52 x 40	20,1/2 x 15,3/4
305 05 23 697	62 x 48	24,3/8 x 19

Piatto ovale da portata

Oval dish
 Plate oval
 Fuente oval
 Bratenplatte, oval

	Cm	In
305 05 22 643	30 x 20	11,3/4 x 7,7/8
305 05 22 644	35 x 24	13,3/4 x 9,1/2
305 05 22 645	40 x 27	15,3/4 x 10,5/8
305 05 22 646	45 x 30	17,3/4 x 11,3/4
305 05 22 647	50 x 34	19,3/4 x 13,3/8



Piatto ovale da portata con copripiatto

Oval dish with cover
 Plat oval avec cloche
 Fuente oval con cubreplato
 Bratenplatte, oval, mit Deckel

	Cm	In
305 05 22 643	30 x 20	11,3/4 x 7,7/8
305 05 53 551 (Coperchio - Cover)	30 x 20	11,3/4 x 7,7/8
305 05 22 645	40 x 27	15,3/4 x 10,5/8
305 05 53 552 (Coperchio - Cover)	40 x 27	15,3/4 x 10,5/8
305 05 22 647	50 x 34	19,3/4 x 13,3/8
305 05 53 553 (Coperchio - Cover)	50 x 34	19,3/4 x 13,3/8



Piatto tondo da portata con copripiatto

Round plate with cover
 Plat rond avec cloche
 Fuente redonda con cubreplato
 Servierplatte, rund mit Deckel

	Ø Cm	Ø In
305 05 22 637	26	10,1/4
305 05 53 548 (Coperchio - Cover)	26	10,1/4
305 05 22 638	32	12,5/8
305 05 53 549 (Coperchio - Cover)	32	12,5/8
305 05 22 639	38	15
305 05 53 550 (Coperchio - Cover)	38	15



Piatto salmone (argentato/legno)

Salmon cutting board (electro-plated stainless steel and wood)
 Planche à saumon (acier argenté et bois)
 Fuente salmón (acero plateado y madera)
 Lachsplatte, versilbert mit Holz

	Cm	In
305 07 22 656	87 x 19	34,1/4 x 7,1/2



Piatto pesce

Fish dish
 Plat à poisson
 Fuente pescado
 Fischplatte

	Cm	In
305 05 22 663	70 x 28,5	27,1/2 x 11,1/4



Vassoio tondo per banchetti

banquet tray
 Plateau rond pour banquets
 Bandeja redonda para banquetes
 Bankettservierbrett, rund

	Ø Cm	Ø In
305 05 22 651	80	31,1/2



Vassoio tondo

Round tray
 Plateau rond
 Bandeja redonda
 Tablett, rund

	Ø Cm	Ø In
305 05 23 507	35	13,3/4
305 05 23 508	40	15,3/4
305 05 23 509	45	17,3/4



Piatto ovale da portata

Oval dish
Plat oval
Fuente oval
Servierplatte, oval

	Cm	In
305 05 22 517	36 x 25	14,1/8 x 9,7/8
305 05 22 519	38 x 26	15 x 10,1/4
305 05 22 520	47 x 34	18,1/2 x 13,3/8
305 05 22 522	53 x 35	20,7/8 x 13,3/4
305 05 22 515	29 x 20	11,1/2 x 7,7/8
305 05 22 524	59 x 40	23,1/4 x 15,3/4



Copripiatto sovrapponibile

Plate cover, stackable
Cloche ronde empilable
Cubreplato apilable
Cloche, stappelbar

	Ø Cm	Ø In
305 05 53 619	24.5	9,5/8
305 05 53 620	27	10,5/8
305 05 53 621	28	11
305 05 53 604	29	11,1/2
305 05 53 622	30	11,3/4
305 05 53 618	31	12,1/4



Piatto tondo da portata

Round plate
Plat rond
Fuente redonda
Servierplatte, rund

	Ø Cm	Ø In
305 05 22 505	29	11,1/2
305 05 22 507	38	15



Portacannucce e portacucchiaini Imperial

Imperial straw holder and tea spoon holder
Porte-pailles et porte-cuillers à café Imperial
Portapajitas y portacucharitas café Imperial
Trinkhalme/Löffelbehälter Imperial

Portacucchiaini - Tea spoon holder

	Ø Cm	H Cm	Ø In	H In
V01 05 71 008	9	8	3,1/2	3,1/8

Portacannucce - Straw holder

	Ø Cm	H Cm	Ø In	H In
V01 05 71 011	9	11	3,1/2	4,3/8



Spargicacao

Cocoa shaker
Saupoudreuse de cacao
Espolvoreador de cacao
Kakaostreuer

	Ø Cm	Ø In	Cl	Oz
909 05 x x 028	5,3	2,1/8	18	6



Shaker

Cocktail shaker
Shaker
Coctelera
Cocktail Shaker

	Lt	Oz
V78 05 81 SHA	0,50	18

Acciaio inossidabile 18/10 - Stainless steel 18/10



Bicchieri Boston

Boston mixing container
Verre en métal pour Boston
Vaso en metal para Boston
Boston Metallbecher

	H Cm	H In
V78 05 81 SHA 2B	17	6,3/4



Vetro per bicchiere Boston

Boston glass
Verre pour Boston
Vaso en vidrio para Boston
Boston Rührglas

	Lt
V78 08 81 SHA 2B	0,7

Misurino Basic

Basic jigger
Mésure Basic
Meßbecher Basic
Medida bar Basic

	MI	Oz
V78 05 81 DOS1	15-30	1/2-1



Filtro cocktail Basic

Basic cocktail strainer
Passoire à cocktail Basic
Barsieb Basic
Colador de cóctel Basic

	Cm	In
V78 05 81 FCO1	14	5,1/2



Lampada da tavolo

Candle lamp
Lampe à bougie
Lampara de vela
Windlicht mit Kristall

	H Cm	H In
305 05 17 512	21	8,1/4

Ricambio cristallo - Spare crystal part
 310 09 17 505



Vasetto portafiori

Flower vase
Vase à fleurs
Florero
Blumenvase

	H Cm	H In
V01 05 19 015	16	6,1/4



Portauovo

Egg cup
Coquetier
Huevera
Eierbecher

	Ø Cm	Ø In
V01 05 71 001	6	2,3/8



Passatè con coppetta

Tea strainer with drip bowl
Passoire à thé avec petite coupe
Colador de té con copita
Teesieb mit Schälchen

	Cm	In
V01 05 91 001	7	2,3/4



Portazucchero 2 pz c/dosatore

Sugar holder 2 pcs with dispenser
Porte-sucre 2 pièces avec doseur
Portaazúcar 2 piezas con dosificador
Zuckerhalter 2 Stück mit Dosierer

305 05 81 748



Dosa zucchero

Sugar dispenser
Distributeur de sucre
Dosificador de azúcar
Zuckerdosierer

	Cl	Oz
305 05 81 746	10	3,5



Portamenù Acciaio Inox

Menu support St.Steel
Porte-menu Acier Inox
Porta menú Acero Inox
Menükartenhalter, Edelstahl

	Cm	In	H Cm	H In
305 05 18 539	8 x 5	3,1/8	2	0,3/4

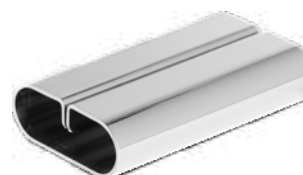

Numero tavola / segnaposto

Table number / place card
Numéro de table / marque-place
Número de mesa / etiqueta
Tischnummer

	Cm	In
305 05 19 517	11,5 x 6,5	4,1/2 x 2,1/2



Levatappi cameriere

Waiter's corkscrew
Tire-bouchons sommelier
Sacacorchos de camarero
Kellner-Korkenzieher

305 05 71 687



Supporto versavino a filo

Red wine holder stand
Support pour porte-bouteille
Soporte para portabotella
Rotweingestell

	Cm	H Cm	In	H In
V01 05 24 022	22	20,5	8,5/8	8



Portadecanter in acciaio

Decanter stand, stainless steel
Egouttoir à carafe en acier inox idable
Soporte para decantador en acero inox idable
Karaffentrockner, Edelstahl

	H Cm	H In
V01 05 24 020	30	11,3/4



Sottobottiglia / sottobicchiere

Bottle coaster / glass coaster
Dessous de bouteille / dessous de verre
Posa botella / posavasos
Flaschenuntersatz / Untersatz

	Ø Cm (Int.)	Ø Cm (Est.)	Ø In (Int.)	Ø In (Est.)
305 05 21 506	9	13,5	3,1/2	5,3/8
305 05 21 505	8	12,5	3,1/2	5,3/8



Posacenere

Ashtray
Cendrier
Cenicero
Ascher

	Cm	In
305 05 71 504	11,5 x 11,5	4,1/2 x 4,1/2



Macinapepe in legno naturale

Wood pepper mill, light colour
Moulin à poivre en bois naturel
Molinillo pimienta en madera natural
Holzpfeffermühle, hell-braun

	H Cm	H In
489 00 61 50N	13	5,1/8
489 00 61 52N	25	9,78
489 00 61 53N	33	13
489 00 61 55N	53	20,7/8



Macinapepe in legno noce

Wood pepper mill, dark colour
Moulin à poivre en bois foncé
Molinillo pimienta en madera oscura
Holzpfeffermühle, dunkel-braun

	H Cm	H In
489 00 61 50T	13	5,1/8
489 00 61 51T	19	7,1/2
489 00 61 52T	25	9,78
489 00 61 53T	33	13
489 00 61 54T	42	16,1/2
489 00 61 55T	53	20,7/8



Complementi

Macinasale in metacrilato

Acrylic salt mill
Moulin à sel acrylique
Molinillo sal acrílico
Salzmühle, Acryl

	H Cm	H In
489 00 84 10S	12	4,3/4
489 00 84 20S	17,5	6,7/8
489 00 84 30S	22	8,5/8
489 00 84 40S	32	12,5/8



Macinapepe in metacrilato

Acrylic pepper mill
Moulin à poivre acrylique
Molinillo pimienta acrílico
Pfeffermühle, Acryl

	H Cm	H In
489 00 08 410	12	4,3/4
489 00 08 420	17,5	6,7/8
489 00 08 430	22	8,5,8
489 00 08 440	32	12,5/8



Macinapepe in legno

Wooden pepper mill
Moulin à poivre en bois
Molinillo pimienta de madera
Holzpeffermühle

	H Cm	H In
305 04 12 562	18	7,1/8
305 04 12 563	25	9,7/8
305 04 12 564	36	14,1/8



Macinapepe quadro in metacrilato

Square pepper mill, acrylic
Moulin à poivre carré acrylique
Molinillo pimienta cuadrado acrílico
Pfeffermühle quadrat, Acryl

	H Cm	H In
489 00 00 826	14,5	5,3/4
489 00 00 839	9	3,1/2



Macinasale quadro in metacrilato

Square salt mill, acrylic
Moulin à sel carré acrylique
Molinillo sal cuadrado acrílico
Salzmühle quadrat, Acryl

	H Cm	H In
489 00 08 26S	14,5	5,3/4
489 00 08 39S	9	3,1/2



Macina pepe bombato

Curved pepper mill
Moulin à poivre bombé
Molinillo de pimienta abombado
Gewölbte Pfeffermühle

		H Cm	H In
305 04 12 630B	■	17	6 3/4
305 04 12 630N	■	17	6 3/4
305 04 12 630R	■	17	6 3/4
305 04 12 630V	■	17	6 3/4



Macina pepe conico nero opaco

Conical pepper mill h.17cm matte black
Moulin à poivre conique noir mat
Molinillo de pimienta cónico negro mate
Kegelförmige Pfeffermühle matt schwarz

	H Cm	H In
305 04 12 631N	17	6 3/4







Classica

Alpacca Argentata - EPNS

To make a Rubans coffee pot the first step is to shear

the disk (1), that is, a disk of a suitable diameter is cut out of a nickel silver sheet. By means of a die the body is drawn first (2) to get the cylindrical body of the coffee pot; afterwards the body is tapered (3) to obtain the conicity desired. Once the body is ready, the edge is braze-welded (4), and then the body is drilled adequately and the goose-neck is braze-welded (5) too. Afterwards the handle is welded (6). Once the lid is drawn (7), the knob is braze-welded (8) and the hinge is welded to the lid and the body (9). Now the coffee pot is finished. The process ends when the coffee pot is polished and silver-plated (10).

Pour la réalisation d'une cafetière Rubans, on part du

découpage du disque (1), où, à partir de la tôle, on découpe un disque du diamètre opportun en maillechort. Moyennant un moule, on commence d'abord par l'emboutissage du corps (2) jusqu'à l'obtention du corps cylindrique de la cafetière, et ensuite on procède à la striction du corps (3) pour obtenir la conicité désirée. Une fois que le corps a été obtenu, on procède au soudo-brasage du bord (4), puis on troue opportunément le corps et on applique avec soudo-brasage le col de cygne (5). On procède ensuite à la soudure du manche (6). Après l'emboutissage du couvercle (7), on procède au soudo-brasage du pommeau (8) et à la soudure de la charnière au couvercle et au corps (9). À ce point-là, la cafetière est complète : la réalisation se termine par le polissage et l'argenture de l'objet (10).

Para la realización de una cafetera Rubans se comienza

por el troquelado del disco (1), con el que en la chapa se corta un disco de alpaca del diámetro oportuno. Mediante un molde se procede primero a la embutición del cuerpo (2) hasta obtener el cuerpo cilíndrico de la cafetera, y luego se procede a la conificación del cuerpo (3) para obtener la conicidad deseada. Una vez obtenido el cuerpo, se procede a la bronzesoldadura del borde (4), luego se perfora oportunamente el cuerpo y se aplica con bronzesoldadura el cuello de cisne (5). Se procede entonces con la soldadura del mango (6). Después de la embutición de la tapa (7), se procede a la bronzesoldadura del pómulo (8) y con la soldadura de la bisagra a la tapa y al cuerpo (9). A estas alturas la cafetera

Bei der Anfertigung einer Rubans Kaffekanne startet

man mit dem Schnitt der Scheibe (1), d.h. aus dem Alpaka Blech wird eine Scheibe von geeignetem Durchmesser ausgeschnitten. Mit Hilfe eines Gesenks erfolgt dann das Tiefziehen des Körpers (2) bis man den Hohlkörper der Kanne erhält, danach wird der Körper konisch geformt (3) um die gewünschte (Kegelverjüngung) zu erhalten. An dem so erhaltenen Körper nimmt man das Hartlöten des Randes (4) vor, der Körper wird gelocht und der Schwanenhalshahn wird durch Hartlöten angebracht (5). Als nächster Schritt erfolgt das Weichlöten des Griffs (6). Nach Tiefziehen des Deckels (7) wird der Knauf durch Hartlöten angebracht (8) und das Scharnier an Deckel und Körper angelötet (9). Jetzt ist die Kaffekanne fertig und man beginnt mit dem Polieren und Versilbern des Gegenstandes (10).

Alpacca

Fasi di lavorazione

Per la realizzazione di una caffettiera Rubans si parte

dalla tranciatura del disco (1), dove dalla lamiera si va a tranciare un disco del \varnothing opportuno in Alpacca. Mediante uno stampo si procede prima con l'imbutitura del corpo (2) fino ad ottenere il corpo cilindrico della caffettiera, e poi si procede con la conifica del corpo (3), per ottenere la conicità desiderata. Una volta ottenuto il corpo, si procede con la saldobrasatura del bordo (4), poi si fora opportunamente il corpo e si applica la saldobrasatura del collo di cigno (5). Si procede poi con la saldatura del manico (6). Dopo l'imbutitura del coperchio (7), si procede con la saldobrasatura del pomolo (8) e con la saldatura della cerniera al coperchio e al corpo (9). A questo punto la caffettiera è completa: la lavorazione termina con la lucidatura e l'argentatura dell'oggetto (10).

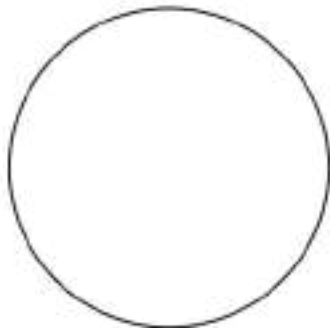

1
Tranciatura
Shearing



2
Imbutitura
Drawing



3
Conifica
Tapering



4
Saldobrasatura bordo
Braze-welding



5
Saldobrasatura collo di cigno
Goose-neck braze-welding



6
Saldatura manico
Handle welding



7
Imbutitura coperchio
Lid drawing



8
Saldobrasatura pomolo
Knob braze-welding



9
Saldatura cerniera
Hinge welding



10
Lucidatura e argentatura
Polishing and silver plating



Caffettiera Ambasciata

Ambasciata coffee pot
 Cafetière Ambasciata
 Cafetera Ambasciata
 Kafeekanne Ambasciata

	Lt	Oz
310 00 01 567	0,40	13,5
310 00 01 578	0,85	30
310 00 01 579	1,50	53

**Teiera Ambasciata**

Ambasciata teapot
 Théière Ambasciata
 Tetera Ambasciata
 Teekanne Ambasciata

	Lt	Oz
310 00 02 551	0,35	12
310 00 02 552	0,75	25
310 00 02 553	1,00	35

**Cremiera / lattiera Ambasciata**

Ambasciata creamer / milk jug
 Crémier / pot à lait Ambasciata
 Jarrita de leche / lechera Ambasciata
 Milchkanne Ambasciata

	Lt	Oz
310 00 03 588	0,15	6
310 00 03 589	0,40	13,5
310 00 03 590	0,70	23,5

**Zuccheriera Ambasciata**

Ambasciata sugar bowl
 Sucrier Ambasciata
 Azucarero Ambasciata
 Zuckerdose Ambasciata

	Lt	Oz
310 00 04 503	0,2	7,05



Classica

Portazucchero con coperchi

Sugar bowls with covers
Sucriers avec couvercles
Azucareros con tapas
Zuckerdose mit Deckeln

	H Cm	H In
310 00 04 522	12	4,3/4



Brocca acqua

Water pitcher
Carafe à eau
Jarra agua
Eiswasserkrug

	Lt	Oz
310 00 08 532	0,70	23
310 00 08 524	1,20	42
310 00 08 525	1,60	54



Portasalatini / portazucchero

Snack / sugar holder
Service apéritif / sucrier
Entremesera / azucarero
Salzgebäckschale / Zuckerdose

		Ø Cm	Ø In
310 00 04 524	3 comp.-3 dish	8,5	3,3/8
310 00 41 508	4 comp.-4 dish	8,5	3,3/8
310 09 04 564	coppetta vetro-glass bowl		



Alzata frutta

Fruit stand
 Plat à fruits sur pied
 Frutero
 Obststände

	Ø Cm	Ø In	H Cm	H In
310 00 42 574	30	11,3/4	8	3 1/8
310 00 42 539	40	15,3/4	10	4
310 00 42 549	54	21,1/4	12	4 3/4

**Alzata frutta**

Fruit stand
 Plat à fruits sur pied
 Frutero
 Obststände

	Ø Cm	Ø In	H Cm	H In
310 00 42 507	25	9,7/8	12,5	4,7/8
310 00 42 535	30	11,3/4	12,5	4,7/8

**Alzatina piccola pasticceria**

Petits fours stand
 Plat à petits fours sur pied
 Soporte pastas de té
 Petits-Fours Ständer

	Ø Cm	Ø In	H Cm	H In
310 00 42 508	14	5,1/2	10	4
310 00 42 509	17	6,3/4	12	4 3/4
310 00 42 510	21	8,1/4	14	5 1/2

**Alzata torta**

Cake stand
 Presentoir à gâteau x
 Soporte pastel
 Tortenplatte

	Ø Cm	Ø In	H Cm	H In
310 00 42 526	32	12,5/8	10	4



Alzata 3 coppette salatini

Snack stand, 3-cup
Présentoir à biscuits salés 3 coupelles
Soporte con 3 copas para aperitivos salados
Snacketagere, 3-Becher

	Ø Cm	Ø In
310 00 42 697	8.5	3 3/8



Piatto piccola pasticceria con stelo e pigna

Small pastry plate with stem and pine cone
Assiette à petits gâteaux avec tige et pomme de pin
Plato para pasteles pequeños con tallo y piña
Kleine Kuchenplatte mit Stiel und Tannenzapfen

	Cm	In
310 00 42 520	14	5 1/2



Alzata piccola pasticceria con piede lavorato

Small pastry stand with decorative base
Présentoir à petits gâteaux avec pied profilé
Pastelera pequeña con pie moldeado
Kleine Kuchenplatte mit geformtem Boden

	Ø Cm	Ø In
310 00 42 518	14	5 1/2



Portamarmellata

Jam display
Présentoir à confiture
Soporte mermeladas
Konfitüreschale - Display

	H Cm	H In
310 00 41 521	20	7,7/8

Con vaso fiori - With flower vase

	H Cm	H In
310 00 41 509	17	6,3/4

Con pomolo - With knob



Samovar

Samovar
Samovar
Samovar
Samovar

	H Cm	Lt	H In	Oz
310 00 02 516	46	2	18,1/8	70

**Passatè con coppetta**

Tea strainer with drip bowl
Passoire à thé avec petite coupe
Colador de té con copita
Teesieb mit Schälchen

	Cm	In
301 07 91 724	7,5	3

**Barella per dolci**

Petits fours tray
Petit plateau à petits fours
Bandejita para pasteles
Kuchenplatte

	Cm	In
310 00 41 573	22 x 16	8,5/8 x 6,1/4
310 00 41 575	22 x 26	8,5/8 x 10,1/4

**Coperchio per tazzina moka Stella V&B**

Lid for Stella V&B coffee cup
Couvercle pour tasse à café Stella V&B
Tapa para taza de café Stella V&B
Deckel für Stella V&B Kaffee Tasse

	Ø Cm	Ø In	H Cm	H In
310 00 15 802	6,5	2,36	3,5	1,3/5



Alzatina in filo 3 ripiani con piattini in porc.

Wire stand with 3 shelves and porcelain plates

Présentoir en fil 3 étagères avec assiettes en porcelaine

Pastelera de alambre con 3 bandejas y platillos de porcelana

Drahtständer mit 3 Regalen und Porzellantellern

	Cm	Ø Cm	In	Ø In
Argentata - Silver				
310 00 42 706	21	11	8 1/4	4 3/8
Dorata - Gilded				
310 28 42 706	21	11	8 1/4	4 3/8



Servitore per the / pasticceria

Afternoon tea stand

Support pour service à thé

Soporte e x positor platos postre

Tee/Kuchenstander

	Ø Cm	H Cm	Ø In	H In
Con pomolo per piatti - With knob for dishes				
Ø Cm 25 - 28				
301 07 42 529	29	42	11,1/2	16,1/2
Ø Cm 20 - 24				
301 07 42 533	25	38	9,7/8	15
Senza pomolo per piatti - Without knob for dishes				
Ø Cm 25 - 28				
301 07 42 573	29	39	11,1/2	15,3/8
Ø Cm 20 - 24				
301 07 42 572	25	35	9,7/8	13,3/4



Cestino pane con piede

Bread basket, footed

Corbeile à pain sur pied

Cesta pan con pie

Brotkorb mit Fuß

	Ø Cm	H Cm	Ø In	H In
310 00 24 554	19	8	7,1/2	3,1/8
310 00 24 555	23	8	9	3,1/8



Legatovagliolo

Napkin ring
Rond de serviettes
Servilletero redondo
Serviettenring

	Cm	In
310 02 71 791	4,5	1,3/4



Portatovaglioli

Napkin holder
Porte-serviettes en papier
Servilletero
Serviettenhalter

	Cm	In
310 00 71 525	5	2



Portatovaglioli

Napkin holder
Porte-serviettes en papier
Servilletero
Serviettenhalter

	Cm	In
310 02 71 945	19 x 19	7,1/2 x 7,1/2





Alzata frutta 2-3-4 piani

Fruit stand, 2-3-4-tier

Plat à fruits sur pied, 2-3-4 étages

Frutero, 2-3-4 pisos

Obststände, 2-3-4 stufig

		Ø Cm	H Cm	Ø In	H In
310 00 42 564	(2 piani / 2 tier)	30/25	49	11,3/4-9,7/8	19,5/16
310 00 42 565	(3 piani / 3 tier)	40/30/25	69	15,3/4-11,3/4-9,7/8	27
310 00 42 577	(3 piani / 3 tier)	54/40/30	69	21,1/4-15,3/4-11,3/4	27
310 00 42 571	(4 piani / 4 tier)	54/40/30/25	90	21,1/4-15,3/4-11,3/4-9,7/8	35,3/8

Macinapepe maxi

Pepper mill, maxi
 Moulin à poivre maxi
 Molinillo pimienta maxi
 Pfeffermühle Maxi

	H Cm	H In
310 00 12 524	15	6

**Spargisale - spargipepe - portastecchi**

Salt shaker - Pepper shaker - Toothpick holder
 Salière - Poivrière - Porte cure-dents
 Salero - Pimentero - Palillero
 Pfefferstreuer - Salzstreuer - Zahnstocherträger

		H Cm	H In
①	310 00 12 545	Spargipepe Pepper shaker	9,5 3,3/4
②	310 00 12 546	Spargisale Salt shaker	9,5 3,3/4
③	310 00 11 531	Portastecchi Toothpick holder	7 2,3/4

**Macinapepe e macinasale in metacrilato argentati**

Pepper mill and salt mill, acrylic, EPSS
 Moulin à poivre et moulin à sel acryliques argentés
 Molinillo pimienta y molinillo sal acrílicos plateados
 Pfeffermühle und Salzmühle, Acryl, versilbert

		H Cm	H In
305 02 12 560	Macinasale - Salt mill	14,5	5,3/4
305 02 12 561	Macinapepe - Pepper mill	14,5	5,3/4
305 02 12 602	Macinasale - Salt mill	7	2,3/4
305 02 12 603	Macinapepe - Pepper mill	7	2,3/4



Oliera 2 posti

Oil & vinegar cruet, 2 - piece

Ménagère, 2 pièces

Servicio aceitera vinagrera, 2 piezas

Essig - Ölgestell, 2-tlg

	H Cm	H In
310 00 11 527	22	8,5/8



Oliera 2 posti Luna

Luna oil & vinegar cruet, 2 - piece

Ménagère Luna, 2 pièces

Servicio aceitera vinagrera Luna, 2 piezas

Luna Essig - Ölstände, 2-tlg

	Ø Cm	Ø In
310 02 11 526	20	7,7/8



**Coppa cocktail scampi**

Shrimp cocktail cup
Coupe à cocktail de crevettes
Copa para cóctel de mariscos
Hummer Cocktailschale

	Ø Cm	Ø In
310 00 43 519	11	4,3/8

**Coppa gelato**

Ice cream cup
Coupe à glace
Copa helado
Eisschale

	Ø Cm	Ø In	H Cm	H In
310 00 43 627	10,5	4,1/8	9,5	3,3/4

**Coppa champagne**

Champagne coupe EPNS
Coupe à champagne Argentée
Copa de champán Plateada
Champagerschale, versilbert EPNS

	Ø Cm	Ø In	H Cm	H In
310 00 43 636	10	4,5	15	6

**Coppa Martini**

Martini glass EPNS
Coupe à Martini Argentée
Copa Martini Plateada
Martinischale, versilbert EPNS

	Ø Cm	Ø In	H Cm	H In
310 00 43 637	11	4,3/8	15	6

**Coppa gelato**

Ice cream cup
Coupe à glace
Copa helado
Eisschale

	Ø Cm	Ø In
310 00 43 520	9	3,1/2

**Coppa multiuso lavadita**

Multipurpose bowl / fingerbowl
Coupe multi-usage / rince-doigts
Bol multiuso / lavadedos
Universalschale / fingerschale

	Ø Cm	Ø In
310 00 43 528	12,5	5

Classica



Formaggiera con manico Luna e Sottocoppa per formaggiera

Grated cheese bowl with Luna handle and underliner
Ravier à parmesan avec poignée Luna et dessous de coupe
Quesera con asa Luna y platito posacopa
Käsedose mit Griff - Luna und Käsedoseuntersatz

	Ø Cm	Ø In
310 00 13 510	9	3,1/2
Con manico-With handle		
310 02 22 629	13	5,1/8
Sottocoppa-Underliner		



Formaggiera

Grated cheese bowl
Ravier à parmesan
Quesera
Käsedose

	Ø Cm	Ø In
310 00 13 515	9	3,1/2
A cestello - Basket-shaped		



Portabutto con coperchio e griglia

Butter cooler with cover and grid
Beurrier avec cloche et plat perforé
Mantequera con tapa y parrilla
Butterkühler

		Ø Cm	Ø In
310 00 09 506	Completa - Whole item	11	4,3/8
310 00 15 785	Coperchio - Cover		
305 07 72 502	Griglia - Grid		
310 00 09 554	Corpo con manici - Bowl with handles		



Mostardiera

Mustard pot
Moutardier
Mostacera
Senftopf

	Ø Cm	Ø In
310 00 41 535	6	2,3/8

Numero tavola con linguetta

Table number with tab
 Numéro de table à languette
 Número de mesa con lengüeta
 Tischnummer

	Cm	In
310 00 19 527	11 x 7	4,3/8 x 2,3/4

**Tavoletta serigrafata in metacrilato**

Small plate, methacrylate
 Plaque en méthacrylate
 Plaquita de metacrilato
 Ple x iglas Schild fuer Produktinfo

	H Cm	H In
305 12 19 525	12 x 18	4,3/4 x 7

**Portanumero da tavola**

Table number stand
 Support numéro de table
 Soporte número de mesa
 Tischnummerständer

	H Cm	H In
305 07 19 524	30	11,3/4

**Lampada da tavolo**

Candle lamp
 Lampe à bougie
 Lampara de vela
 Windlicht mit Kristall

		H Cm	H In
310 00 17 502	Con candela With candle	18	7
310 00 17 530	Con combustibile liquido With liquid fuel	18	7
310 12 17 530	Ricambio combustibile liquido Spare liquid fuel		
310 31 81 655	Candela Candle		
310 09 17 505	Ricambio cristallo Lamp shade spare part		



Classica

Vasetto portafiori

Flower vase
Vase à fleurs
Florero
Blumenvase

	H Cm	H In
310 00 19 506	18	7



Salsiera

Sauce boat
Saucière
Salsera
Sauciere

	Cl.	Oz
310 00 12 532	15	6
310 00 12 533	23	9
310 00 12 534	44	17,3/8



Raccogliatrice a pala

Crumb sweeper
Pelle ramasse-miettes
Pala recogemigas
Krümelsammler

	Cm	In
310 00 71 528	30	11,3/4



Portauovo

Egg cup
Coquetier
Huevera
Eierbecher

	H Cm	In
310 00 71 953	7	2,3/4



Cloche in acciaio argentato

Dome cover, electro-plated stainless steel (EPSS)
Cloche en acier argenté
Campana en acero plateado
Speiseglocke, Edelstahl versilbert

	Ø Cm int.	Ø Cm est.	Ø In int.	Ø In est.
310 07 53 554	18	20,5	7	8
310 07 53 555	22	24	8,5/8	9,1/2
310 07 53 556	24	26	9,1/2	10,1/4
310 07 53 562	28	30	11	11,3/4
310 07 53 569	30	32	11,3/4	12,5/8



Piatto presentazione decoro inglese

Show plate, stainless steel, English decoration

*Plat de présentation, décor anglais**Plato de presentación, decoración inglesa**Platzteller - Dekor English*

	Ø Cm	Ø In
310 00 25 518	32,5	12,3/4

**Piatto presentazione decoro Rubans**

Show plate, Rubans decoration

*Plat de présentation, décor Rubans**Plato de presentación, decoración Rubans**Platzteller - Dekor Rubans*

	Ø Cm	Ø In
310 00 25 525	32	12,5/8

**Piatto presentazione decoro Impero**

Show plate, Impero decoration

*Plat de présentation, décor Impero**Plato de presentación, decoración Impero**Platzteller - Dekor Impero*

	Ø Cm	Ø In
310 00 25 515	32	12,5/8

**Piatto presentazione decoro barocco**

Show plate, Baroque decoration

*Plat de présentation, décor baroque**Plato de presentación, decoración barroca**Platzteller - Dekor Barock*

	Ø Cm	Ø In
310 00 25 512	30	11,3/4

Piatto presentazione quadro

Show plate, square

*Plat de présentation, carré**Plato de presentación, cuadrado**Platzteller - quadrat*

	Cm	In
310 00 25 539	32 x 32	12,5/8 x 12,5/8

Secchio champagne ovale 2 bottiglie

Champagne bucket - oval, 2 - bottle

Seau à champagne oval, 2 bouteilles

Champañera oval, 2 botellas

Ovalweinkühler, 2 Flaschen

	H Cm	H In
310 00 20 516	22	8,5/8



Secchio champagne Medici

Medici Champagne bucket

Seau à champagne Medici

Champañera Medici

Weinkühler Medici

	Ø Cm	H Cm	Ø In	H In
310 00 20 644	22	26	8,5/8	10,1/4





Supporto secchio champagne ovale

Champagne bucket stand
Support pour seau à champagne
Soporte para champañera
Weinkühlerstände

		H Cm	H In
310 00 20 520	Ovale - Oval	67	26,3/8



Supporto secchio champagne

Champagne bucket stand
Support pour seau à champagne
Soporte para champañera
Weinkühlerstände

		H Cm	H In
310 00 20 519	Tondo - Round	68	26,3/4



Secchiello ghiaccio e secchio champagne con pomoli

Ice bucket and champagne bucket with knobs
Seau à glace et seau à champagne avec poignées
Cubo hielo y champañera con pomos
Eis / Sektkühler

	Ø Cm	Ø In
310 00 20 524	12	4,3/4
310 00 20 515	20	7,7/8

**Secchiello ghiaccio e secchio champagne con anelli**

Ice bucket and champagne bucket with rings
Seau à glace et seau à champagne à anneau x
Cubo hielo y champañera con anillos
Eis / Sektkühler

	Ø Cm	Ø In
310 00 20 522	12	4,3/4
310 00 20 512	20	7,7/8



Secchio champagne Magnum

Magnun Champagne cooler
Seau à champagne Magnum
Champañera Magnum
Magnum Champagnekühler

	Cm	H Cm	In	H In
310 00 20 673	44 x 27	25	17,3/8 x 10,5/8	9,7/8



Versavino a filo

Red wine holder, wire
Panier à vin tressé
Cesta de vino de malla
Drahtweinkorb

	Cm	In
310 07 24 522	25	9,7/8



Versavino

Red wine holder
Porte-bouteille
Portabotella
Rotweinwiege

	Cm	In
301 07 24 532	30	11,3/4



Glacette

Bottle cooler
Rafraîchisseur à bouteille
Enfriador de botella
Weinkühler

		H Cm	H In
305 02 24 517	Con pomoli - With knobs	24	9,1/2
305 02 24 536	Senza pomoli - Without knobs	24	9,1/2



Classica



Zuppiera

Soup tureen
Soupière
Sopera
Suppenschiessel

	Ø Cm	Ø In
310 00 15 670	16	6,1/4
310 00 15 671	22	8,5/8
310 00 15 672	26	10,1/4

Coperchio - Cover

310 00 15 673	16	6,1/4
310 00 15 674	22	8,5/8
310 00 15 675	26	10,1/4



Legumiera

Vegetable dish
Légumier
Legumbrera
Gemüseschiessel

	Ø Cm	Ø In
310 00 15 601	16	6,1/4
310 00 15 602	22	8,5/8
310 00 15 603	26	10,1/4

Coperchio - Cover

310 00 15 673	16	6,1/4
310 00 15 674	22	8,5/8
310 00 15 675	26	10,1/4

Coppa punch in acciaio argentato

Punch bowl, electro-plated stainless steel (EPSS)
Bol à punch en acier argenté
Champañera en acero plateado
Punchschale, versilbert

	Ø Cm	Ø In	Lt	Oz
310 00 43 570	40	15,3/4	13	439



Padella flambé

Flambé pan
 Poêle à flamber
 Sartén para flambear
 Flambierpfanne

	Ø Cm	Ø In
305 07 72 543	30	11,3/4



Fornello flambé a gas

Flambé burner, gas
 Réchaud à flamber, gaz
 Hornillo para flambear, gas
 Flambierrechaud, Gaskocher

	H Cm	H In
310 00 52 502	30	11,3/4



Classica

Molla formaggio parmigiano

Cheese tongs
Pince à fromage
Pinzas para queso
Käsezange

	Cm	In
310 00 81 530	13	5,1/8



Grattugia formaggio

Cheese grater
Râpe à fromage
Rallador
Reibeisen

	Cm	In
310 00 71 521	24	9,1/2



Tagliatartufi maxi

Truffle cutter, maxi
Coupe-truffes maxi
Cortatrufas maxi
Trüffelschneider, Maxi

	Cm	In
310 00 91 517	25	9,7/8



Vassoio tondo

Tray, round
 Plateau rond
 Bandeja redonda
 Tablett, rund

	Ø Cm	Ø In
310 02 23 542	30	11,3/4
310 02 23 544	43	17

**Piattino pane**

Bread plate
 Plat à pain
 Plato pan
 Brotteiler

	Ø Cm	Ø In
310 00 22 674	15	6

Decoro inglese - English decoration

**Piattino pane**

Bread plate
 Plat à pain
 Plato pan
 Brotteiler

	Ø Cm	Ø In
310 00 22 680	16	6,1/4

Decoro Impero - Impero decoration

**Piattino pane decoro Rubans**

Bread plate
 Plat à pain
 Plato pan
 Brotteiler

	Ø Cm	Ø In
310 00 23 764	16	6,1/4



Piatto ovale bordo rinforzato

Oval plate, reinforced edge
 Plat oval, bord renforcé
 Fuente oval, borde reforzado
 Tablett, oval

	Cm	In
310 00 22 594	27 x 18	10,5/8 x 7
310 00 22 595	33 x 22	13 x 8,5/8
310 00 22 597	38 x 25,5	15 x 10
310 00 22 600	44 x 29,5	17,3/8 x 11,5/8
310 00 22 603	49 x 32,5	19,1/4 x 12,3/4
310 00 22 609	60 x 40	23,5/8 x 15,3/4



Vassoio rettangolare serie marina

Marina rectangular tray
 Plateau rectangulaire Marina
 Bandeja rectangular Marina
 Tablett, rechteckig, Marina

	Cm	In
310 00 23 864	35 x 25	13,3/4 x 9,7/8
310 00 23 865	40 x 30	15,3/4 x 11,3/4
310 00 23 871	45 x 35	17,34 x 13,3/4
310 00 23 866	55 x 42	1,5/8 x 16,5
310 00 23 556	62 x 48	24,3/8 x 19



Piatto tondo bordo rinforzato

Round plate, reinforced edge
 Plat rond, bord renforcé
 Fuente redonda, borde reforzado
 Brattenplatte, rund

	Ø Cm	Ø In
310 00 22 568	22	8,5/8
310 00 22 570	27	10,5/8
310 00 22 572	33	13
310 00 22 574	38	15



Piatto pesce bordo rinforzato

Fish platter, reinforced edge
 Plat à poisson, bord renforcé
 Fuente pescado, borde reforzado
 Fischplatte

	Cm	In
310 00 22 615	90 x 35	35,3/8 x 13,3/4



Vassoio rettangolare serie marina con maniglie bordo rinforzato

Marina rectangular tray with handles, reinforced edge
Plateau rectangulaire Marina avec poignées, bord renforcé
Bandeja rectangular Marina con asas, borde reforzado
Tablett mit Griff, Marina

	Cm	In
310 00 23 867	35 x 25	13,3/4 x 9,7/8
310 00 23 868	40 x 30	15,3/4 x 11,3/4
310 00 23 869	45 x 35	17,3/4 x 13,3/4



	Cm	In
310 00 23 870	55 x 45	21,5/8 x 17,3/4
310 00 23 551	62 x 48	24,3/8 x 19



Piatto tondo bordo rivoltato

Round plate, turned edge
Plat rond, bord retourné
Fuente redonda, borde revuelto
Brattenplatte, rund

	Ø Cm	Ø In
310 00 22 564	29	11,1/2
310 00 22 565	34	13,3/8
310 00 22 566	38	15



Piatto ovale bordo rivoltato

Oval plate, turned edge
Plat oval, bord retourné
Fuente oval, borde revuelto
Brattenplatte, oval

	Cm	In
310 00 22 580	25 x 17	9,7/8 x 6,3/4
310 00 22 582	29 x 20	11,1/2 x 7,7/8
310 00 22 584	34 x 23	13,3/8 x 9
310 00 22 586	38 x 26	15 x 10,1/4
310 00 22 587	44 x 29	17,3/8 x 11,1/2
310 00 22 589	48 x 33	19 x 13
310 00 22 591	59 x 40	23,1/4 x 15,3/4



Vassoio rendiresto bordo inglese

Small change tray
Plateau porte-monnaie
Bandeja portamoneda
Geldplatte

	Cm	In
310 00 23 798	26 x 14	10,1/4 x 5,1/2



Vassoio tondo bordo inglese

Tray with English edge, round
Plateau rond avec rebord anglais
Bandeja redonda con borde inglés
Tablett, rund

	Ø Cm	Ø In
Senza manici - Without handles		
310 00 23 785	35	13,3/4
310 00 23 786	45	17,3/4
Con manici - With handles		
310 00 23 787	35	13,3/4
310 00 23 788	45	17,3/4



Vassoio rettangolare bordo inglese

Tray with English edge, rectangular
 Plateau rectangulaire avec rebord anglais
 Bandeja rectangular con borde inglés
 Tablett, rechteckig

	Cm	In
Senza manici - Without handles		
310 00 23 760	37 x 27	14,1/2 x 10,5/8
310 00 23 762	46 x 36	18,1/8 x 14,1/8
310 00 23 781	55 x 41	21,5/8 x 16,1/8

Con manici - With handles		
310 00 23 782	37 x 27	14,1/2 x 10,5/8
310 00 23 783	46 x 36	18,1/8 x 14,1/8
310 00 23 784	55 x 41	21,5/8 x 16,1/8

**Vassoio ovale bordo inglese**

Tray with English edge, oval
 Plateau oval avec rebord anglais
 Bandeja oval con borde inglés
 Tablett, oval

	Cm	In
Senza manici - Without handles		
310 00 23 757	39 x 29	15,3/8 x 11,1/2
310 00 23 759	46 x 36	18,1/8 x 14,1/8
310 00 23 777	55 x 41	21,5/8 x 17

Con manici - With handles		
310 00 23 778	39 x 29	15,3/8 x 11,1/2
310 00 23 779	46 x 36	18,1/8 x 14,1/8
310 00 23 780	55 x 43	21,5/8 x 17





**Candelabro
11 / 13 luci
Ambasciata**

Ambasciata candelabrum, 11/13-light
Candélabre Ambasciata 11/13 lumières
Candelabro Ambasciata 11/13 luces
11/13-armig, Kerzenleuchter Ambasciata

	H Cm	H In
310 00 18 543 (11)	82	32,1/4
310 00 18 544 (13)	97	38,1/4

**Candelabro
5 luci
Ambasciata**

Ambasciata candelabrum, 5-light
Candélabre Ambasciata 5 lumières
Candelabro Ambasciata 5 luces
5-armig, Kerzenleuchter Ambasciata

	H Cm	H In
310 02 18 537	46	18,1/8



**Candeliera
1 luce**

Candlestick, 1-light
Flambeau 1 lumière
Candelerio 1 luz
1-armig, Leuchter

	H Cm	H In
310 00 18 512	7	2,3/4
310 00 18 510	21	8,1/4
310 00 18 539	25	9,7/8



**Candelabro
3 luci**

Candelabrum, 3-light
Candélabre 3 lumières
Candelabro 3 luces
3-armig, Kerzenleuchter

	H Cm	H In
310 00 18 508	40	15,3/4



**Candelabro
5 luci**

Candelabrum, 5-light
Candélabre 5 lumières
Candelabro 5 luces
5-armig, Kerzenleuchter

	H Cm	H In
310 00 18 509	40	15,3/4



**Candeliera basso
1 luce
Ambasciata**

Ambasciata candlestick, short, 1-light
Flambeau Ambasciata bas 1 lumière
Candelerio Ambasciata bajo 1 luz
1-armig, Leuchter Ambasciata, klein

	H Cm	H In
310 00 18 545	23	9



**Candelabro basso
3 luci
Ambasciata**

Ambasciata candelabrum, short, 3-light
Candélabre Ambasciata bas 3 lumières
Candelabro Ambasciata bajo 3 luces
3-armig, Kerzenleuchter Ambasciata, klein

	H Cm	H In
310 00 18 546	36	14,1/8



**Candelabro basso
5 luci
Ambasciata**

Ambasciata candelabrum, short, 5-light
Candélabre Ambasciata bas 5 lumières
Candelabro Ambasciata bajo 5 luces
5-armig, Kerzenleuchter Ambasciata, klein

	H Cm	H In
310 00 18 547	36	14,1/8





Rubans
Alpacca Argentata - EPNS

Rubans



Caffettiera Rubans con beccuccio

Rubans goose-neck coffee pot
Cafetière Rubans avec bec
Cafetera Rubans de pico
Kaffeekanne Rubans - mit Schnäbelchen

	Lt	Oz
310 00 01 530	0,24	8
310 00 01 532	0,48	16
310 00 01 535	0,72	24
310 00 01 537	0,96	33,3/4
310 00 01 540	1,40	49



Caffettiera Rubans con nasello

Rubans coffee pot
Cafetière Rubans
Cafetera Rubans
Kaffeekanne Rubans

	Lt	Oz
310 00 01 554	0,24	8
310 00 01 556	0,48	16
310 00 01 575	0,72	24
310 00 01 576	0,96	33,3/4
310 00 01 577	1,40	49



Teiera Rubans con beccuccio

Rubans goose neck pot
Theière Rubans avec bec
Tetera Rubans de pico
Teekanne Rubans - mit Schnäbelchen

	Lt	Oz
310 00 02 524	0,30	10
310 00 02 526	0,50	18
310 00 02 528	0,75	25
310 00 02 530	1,00	35



Teiera Rubans con nasello

Rubans teapot
Theière Rubans
Tetera Rubans
Teekanne Rubans

	Lt	Oz
310 00 02 543	0,30	10
310 00 02 544	0,50	18
310 00 02 545	0,75	25
310 00 02 546	1,00	35



Rubans



Cremiera / lattiera Rubans

Rubans creamer / milk pot
Crémier / pot à lait Rubans
Jarrita de leche / lechera Rubans
Gießer / Milchkanne Rubans

	Lt	Oz
310 00 03 530	0,15	6
310 00 03 544	0,24	8
310 00 03 546	0,48	16
310 00 03 548	0,72	24
310 00 03 550	0,96	33,3/4
310 00 03 552	1,40	49



Portamarmellata con anello Rubans

Rubans jam display with ring
Présentoir à confiture avec anneau Rubans
Soporte mermeladas con anillo Rubans
Konfitüreschale Rubans

	H Cm	H In
310 00 09 555	17	6,3/4



Zuccheriera Rubans

Rubans sugar bowl
Sucrier Rubans
Azucarero Rubans
Zuckerdose Rubans

	Gr	Oz
310 00 04 532	140	4,90
310 00 04 534	250	8,75
310 00 04 536	360	12,60
310 00 04 538	540	18,90



Portasalatini / portazucchero Rubans

Rubans snack / sugar holder
Service coupelles / sucrier Rubans
Entremesera / azucarero Rubans
Salzgebäckschale / Zuckerdose Rubans

	Ø Cm	H Cm	Ø In	H In
310 00 41 538	9	18	3,1/2	7
3 comparti - 3 dish				
310 00 41 539	9	18	3,1/2	7
4 comparti - 4 dish				
310 09 04 564	Coppetta vetro - Glass bowl			

senza coppette vetro / w/o glass bowls

Secchio spumante 1/2 - bottiglie Rubans

Rubans champagne bucket, 1/2 - bottle
Seau à champagne Rubans, 1/2 bouteilles
Cubo champán Rubans, 1/2 botellas
Sektkühler 1/2 Flaschen Rubans

	Ø Cm	H Cm	Ø In	H In
310 00 20 558	21	22,5	8,1/4	8,7/8

**Secchio ghiaccio Rubans**

Rubans ice bucket
Seau à glace Rubans
Cubo hielo Rubans
Eis kühler Rubans

	Ø Cm	H Cm	Ø In	H In
310 00 20 654	14	15	5,1/2	6

**Supporto secchio spumante Rubans**

Rubans champagne bucket stand
Supporte pour seau à champagne Rubans
Soporte para cubo champán Rubans
Weinkühlerständer Rubans

	H Cm	H In
310 00 20 560	65	25,5/8





Secchio ghiaccio termico / Sorbettiera con coperchio Rubans

Rubans thermal ice bucket / Sherbet pot with cover
Seau à glace isotherme / Sorbetière avec couvercle Rubans
Cubo hielo térmico / Sorbetera con tapa Rubans
Eis/SorbettKühler mit Deckel Rubans

	Ø Cm	H Cm	Ø In	H In
310 00 20 653	14	17	5,1/2	6,3/4
Secchio ghiaccio - Ice bucket				
310 00 21 529	14	17	5,1/2	6,3/4
Sorbettiera - Sherbet pot				



Servizio caviale Rubans

Rubans caviar service set
Service à caviar Rubans
Servicio de caviar Rubans
Kaviar-Set Rubans

	Ø Cm	H Cm	Ø In	H In
310 00 42 588	16	9,5	6,1/4	3,3/4
Per contenitori standard				
For standard containers				
310 00 42 591	16	9,5	6,1/4	3,3/4
Con coppa in cristallo				
With crystal bowl				



Cucchiaio caviale

Caviar spoon
Cuillère à caviar
Cucharita de caviar
Kaviarlöffel

	Cm	In
305 12 91 782	10	4



Coppa punch con manici Rubans

Punch bowl with Rubans handles
Bol à punch avec poignées Rubans
Champañera con asas Rubans
Punchschale mit Griff Rubans

	Ø Cm	Lt	Ø In	Oz
310 00 43 602	50	30	19,3/4	1014



Rubans

Legatovagliolo Rubans

Rubans napkin ring
Anneau porte-serviettes Rubans
Servilletero redondo Rubans
Serviettenring Rubans

	Cm	In
310 00 81 644	5	2



Portatoasts Rubans

Rubans toast rack
Porte-toasts Rubans
Portatostadas Rubans
Toastständer Rubans

	Cm	H Cm	Ø In	H In
310 00 71 883	16	13	6,1/4	5,1/8



Lampada da tavolo

Candle lamp
Lampe à bougie
Lampara de vela
Windlicht mit Kristall

		H Cm	H In
310 00 17 502	Con candela With candle	18	7
310 00 17 530	Con combustibile liquido With liquid fuel	18	7
310 12 17 530	Ricambio combustibile liquido Spare liquid fuel		
310 31 81 655	Candela Candle		
310 09 17 505	Ricambio cristallo Lamp shade spare part		



Fruttiera Rubans

Rubans fruit bowl
 Coupe à fruits Rubans
 Frutero Rubans
 Fruchtschale Rubans

	Ø Cm	Ø In
310 00 42 575	22	8,5/8

**Cloche Rubans (acciaio argentato)**

Rubans dome cover, electro-plated stainless steel
 Cloche Rubans en acier argenté
 Cúpula Rubans en acero plateado
 Cloche Rubans - versilbert

	Ø Cm int.	Ø Cm est.	Ø In int.	Ø In est.
310 07 53 591	18	20,5	7	8
310 07 53 592	22	24	8,5/8	9,1/2
310 07 53 593	24	26	9,1/2	10,1/4
310 07 53 594	28	30	11	11,3/4
310 07 53 595	30	32	11,3/4	12,5/8

**Cestino pane Rubans**

Rubans bread basket
 Corbeille à pain Rubans
 Cesta pan Rubans
 Brotkorb Rubans

	Ø Cm	H Cm	Ø In	H In
310 00 24 539	19	8	7,1/2	3,1/8
310 00 24 543	23	8	9	3,1/8



Rubans

Alzata piccola pasticceria Rubans

Small pastry stand Rubans
Présentoir à petits gâteaux Rubans
Soporte pastas de tè Rubans
Gebäcketagere Klein Rubans

	Ø Cm	Ø In
310 00 42 519	14	5 1/2



Portapatatine con bordo Rubans

Chip holder with rim Rubans
Porte-rites avec rebord Rubans
Portapatatas fritas con borde Rubans
Kartoffelchips Schüssel mit Rand Rubans

	Ø Cm	H Cm	Ø In	H In
310 00 87 510	8	8	3 1/8	3 1/8



Coppetta lavamani Rubans

Hand-washing cup Rubans
Coupe rince-doigts Rubans
Copa lavadedos Rubans
Handwaschschüssel Rubans

	Ø Cm	Ø In
310 00 43 597	12,5	5



Vassoietto portaconto Rubans

Rubans tip tray
 Plateau porte-addition Rubans
 Bandeja para cuentas Rubans
 Geld / Rechnungstablett Rubans

	Cm	In
310 00 23 754	26 x 16	10,1/4 x 6,1/4

**Vassoio rettangolare Rubans**

Rubans tray, rectangular
 Plateau rectangulaire Rubans
 Bandeja rectangular Rubans
 Tablett Rubans, rechteckig

	Cm	In
Senza manici - Without handles		
310 00 23 745	40 x 30	15,3/4 x 11,3/4
310 00 23 744	55 x 42	21,5/8 x 16,1/8
310 00 23 743	66 x 46	25,1/4 x 17,1/8
Con manici - With handles		
310 00 23 753	40 x 30	15,3/4 x 11,3/4
310 00 23 752	55 x 41	21,5/8 x 16,1/8
310 00 23 736	66 x 46	25,1/4 x 17,1/8

**Vassoio tondo Rubans**

Rubans tray, round
 Plateau rond Rubans
 Bandeja redonda Rubans
 Tablett Rubans, rund

	Ø Cm est.	Ø In est.
Senza manici - Without handles		
310 00 23 734	37	14,1/2
310 00 23 735	48	19
Con manici - With handles		
310 00 23 746	37	14,1/2
310 00 23 747	48	19

**Vassoio ovale Rubans**

Rubans tray, oval
 Plateau oval Rubans
 Bandeja oval Rubans
 Tablett Rubans, oval

	Cm	In
Senza manici - Without handles		
310 00 23 748	40 x 30	15,3/4 x 11
310 00 23 750	50 x 36	19,3/4 x 14,1/8
Con manici - With handles		
310 00 23 749	40 x 30	15,3/4 x 11
310 00 23 751	50 x 36	19,3/4 x 14,1/8



Gallery

Oliera due posti Gallery

Oil and vinegar cruet, 2 piece

Ménagère, 2 pieces

Servicio aceitera vinagrera

Serviettenring Rubans

	Cm	H Cm	In	H In
310 00 11 622	14,5 x 6,5	30	5,3/4 x 2,3/8	11,3/4
Ø anelli - Ø rings	5,5		2 1/8	



Portabustine Gallery

Gallery sugar-bag holder, rectangular

Sucrier rectangulaire Gallery

Azucarero rectangular Gallery

Zuckerbehälter

	Cm	In
310 00 41 571	9 x 7	3,1/2 x 2,3/4



Vassoio con portabustine Rubans / Gallery

Rubans / Gallery tray with sugar-bag holders

Plateau avec sucriers Rubans / Gallery

Bandeja con azucareros Rubans / Gallery

Tablett mit Zuckerbehälter, Rubans / Gallery

	Cm	In
310 00 04 575	26 x 16	10,1/4 x 6,1/4



Sottobottiglia Gallery

Gallery bottle coaster

Sous-bouteille Gallery

Posa botella Gallery

Flaschenuntersatz

	Ø Cm	H Cm	Ø In	H In
316 02 21 529	10	4,5	4	1,3/4



Porta macinini Rubans / Gallery

Rubans / Gallery tray with sugar-bag holders

Plateau avec sucriers Rubans / Gallery

Bandeja con azucareros Rubans / Gallery

Tablett mit Zuckerbehälter, Rubans / Gallery

		Cm	In
310 00 12 628	Cestino	7 x 4	2,3/4 x 1,1/2
305 02 12 602	Macinasale - Salt mill	7	2,3/4
305 02 12 603	Macinapepe - Pepper mill	7	2,3/4



Cestino pane Gallery

Gallery bread basket
Corbeille à pain Gallery
Cesta pan Gallery
Brotkorb Gallery

	Ø Cm	Ø In
310 00 24 548	19	7,1/2
310 00 24 547	23	9



Portamarmellata 4 posti Gallery

4-cup jam holder Gallery
Porte-confiture 4 emplacements Gallery
Soporte mermeladas de 4 plazas Gallery
Marmeladenhalter für 4 Gläser Gallery

	Cm	H Cm	In	H In
310 00 09 571	5 x 18	3	2 x 7	1 1/8



Vassoio senza maniglia Gallery

Tray without handle Gallery
Plateau sans poignée Gallery
Bandeja sin asa Gallery
Tablett ohne Griff Gallery

	Cm	H Cm	In	H In
310 00 23 872	40 x 30	4	15 3/4 x 11 3/4	1 1/2



Portatovaglioli Gallery

Napkin holder Gallery
Porte-serviettes Gallery
Servilletero Gallery
Serviettenhalter Gallery

	Cm	In
310 00 71 993	13 x 13	5 1/8 x 5 1/8







Vassoio in fibra di
Carbonio

Carbon fibre tray
Plateau en fibre de carbone
Bandeja de fibra de carbono
Tablett aus Holzfaserplatte

Carbonio

Vassoio rett. carbonio c/man. incassate

Rectangular carbon tray with recessed handles
Plateau rectangulaire en carbone avec poignées encastrées
Bandeja rectangular de carbono con asas empotradas
Rechteckiges Tablett aus Carbon mit versenkten Griffen

	Cm	In	g	lb
305 05 23 879	est./out. 48 x 36	18,7/8 x 14,1/8	390	0,85
	Int./ins. 43 x 32	16,7/8 x 12,5/8		

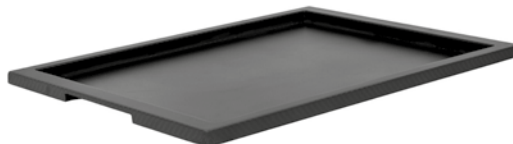

Vassoio rett. carbonio

Carbon fibre tray
Plateau en fibre de carbone
Bandeja de fibra de carbono
Tablett aus Holzfaserplatte

	Cm	In	g	lb
305 05 23 880	est./out. 94 x 33,5	37 x 13,1/5	640	1,411
	Int./ins. 89 x 30,5	35 x 12		

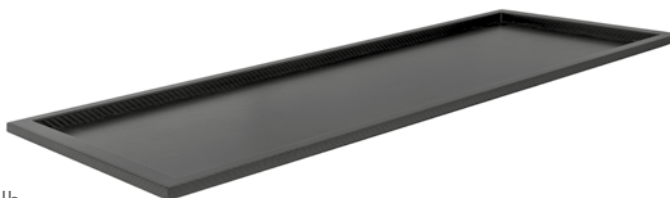

Vassoio in fibra di carbonio

Carbon fibre tray
Plateau en fibre de carbone
Bandeja de fibra de carbono
Tablett aus Holzfaserplatte

con maniglie acciaio - with St. Steel handles

	Cm	In	g	lb
305 05 23 851	est./out. 67 x 52	26,3/8 x 20,1/2	1010	2,227
	Int./ins. 62 x 48	24,3/8 x 19		

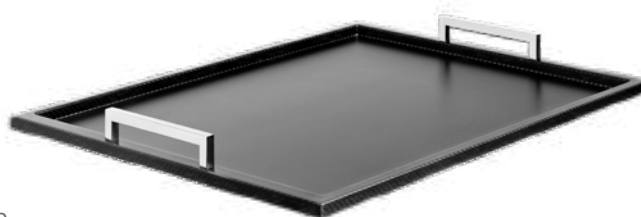

Tappetino antiscivolo per vassoio

Non-slip mat for tray
Tapis antidérapant pour plateau
Rutschfeste Mattepara bandeja
Alfombrilla antideslizante fur Tablett

	Cm	In
305 12 27 503	62 x 48	24,3/8 x 19
305 12 27 512	43 x 32	16,7/8 x 12,5/8





Vassoio in fibra di carbonio impilabili

Stackable carbon fibre tray
 Plateau empilable en fibre de carbone
 Bandeja apilable de fibra de carbono
 Stapelbares Tablett aus Carbonfaser

con maniglie incassate - with recessed handles

	Cm	In
305 05 23 853	65 x 52	26,3/8 x 20,1/2

con maniglie acciaio - with St. Steel handles

	Cm	In
305 05 23 852	65 x 52	26,3/8 x 20,1/2





Secchio champagne, fibra di carbonio

Champagne cooler, carbon fibre
 Seau à champagne en fibre de carbone
 Champañera en fibras de carbono
 Champagnerkühler, karbon

	Ø Cm	H Cm	g	lb
335 05 20 695	20	21	400	0,882

**Supporto secchio Modern**

Modern bucket stand
 Modern bucket stand
 Modern bucket stand
 Modern bucket stand

	H Cm	In
V78 44 20 676	57	22,1/2

Acciaio/finitura titanio
 Steel/titanium finish



Bento





Bento box quadrata, legno nero

Bento box , square, black wood
 Bento box carrée, bois noir
 Bento box cuadrada, madera negra
 Bento-Box , quadratisch, schwarzes Holz

	Cm interni	Cm esterni	H Cm
D10 00 00 696	18 x 18	20,5 x 20,5	7,5

	In interni	In esterni	H In
	7 x 7	8 x 8	3



Bento box rettangolare, legno nero

Bento box , rectangular, black wood
 Bento box rectangulaire, bois noir
 Bento box rectangular, madera negra
 Bento-Box , rechteckig, schwarzes Holz

	Cm interni	Cm esterni	H Cm
D10 00 00 695	24 x 18	27 x 20,5	7,5

	In interni	In esterni	H In
	9,1/2 x 7	10,5/8 x 8	3



Bento box quadrata, legno bianco

Bento box , square, white wood

Bento box carrée, bois blanc

Bento box cuadrada, madera blanca

Bento-Box , rechteckig, weißes Holz

	Cm interni	Cm esterni	H Cm
D10 00 00 697	18 x 18	20,5 x 20,5	7,5
	In interni	In esterni	H In
	7 x 7	8 x 8	3



Vassoio rettang. per porcel. Bento

Tray, rectangular, for Bento porcelain items
 Plateau rectangulaire pour porcelaine Bento
 Bandeja rectangular para porcelana Bento
 Tablett, rechteckig, für Bento-Porzellanartikel

ACCIAIO - St. steel

	Cm	In
305 05 23 907	24 x 18	9 1/2x7

ORO - Gold

305 41 23 907	24 x 18	9 1/2x7
---------------	---------	---------

**Vassoio quadrato per porcel. Bento**

Tray, square, for Bento porcelain items
 Plateau carré pour porcelaine Bento
 Bandeja cuadrada para porcelana Bento
 Tablett, quadratisch, für Bento-Porzellanartikel

ACCIAIO - St. steel

	Cm	In
305 05 23 904	18 x 18	7 x 7

ORO - Gold

305 41 23 904	18 x 18	7 x 7
---------------	---------	-------

**Vassoio rettang. per porcel. Bento**

Tray, rectangular, for Bento porcelain items
 Plateau rectangulaire pour porcelaine Bento
 Bandeja rectangular para porcelana Bento
 Tablett, rechteckig, für Bento-Porzellanartikel

ACCIAIO - St. steel

	Cm	In
305 05 23 905	27 x 9	10,5/8 x 3,1/2

ORO - Gold

305 41 23 905	27 x 9	10,5/8 x 3,1/2
---------------	--------	----------------



Bento



Coppetta Bento conica bianca

Bento small bowl, conical, white
Petit bol Bento conique blanc
Bol pequeño Bento cónico blanco
Bento Schale, klein, konisch, weiß

	Ø Cm	H Cm	Ø In	H In
305 21 54 700	9	5	3,1/2	2



Coppetta Bento cilindrica bianca

Bento small bowl, cylindrical white
Petit bol Bento cylindrique blanc
Bol pequeño Bento cilíndrico blanco
Bento Schale, klein, zylindrisch, weiß

	Ø Cm	H Cm	Ø In	H In
305 21 54 702	5,5	3,5	2,1/8	1,3/8



Piattino Bento rettangolare bianco

Bento saucer, cylindrical white
Soucoupe Bento cylindrique blanc
Soucoupe Bento cilíndrico blanco
Bento Untertasse, zylindrisch, weiß

	Cm	H Cm	In	H In
305 21 54 704	18 x 9	2	7 x 3,1/2	0,3/4



Piattino Bento rettangolare bianco

Bento saucer, rectangular white
Soucoupe Bento rectangulaire blanc
Platito Bento rectangular blanco
Bento Untertasse, rechteckig, weiß

	Cm	H Cm	In	H In
305 21 54 708	9 x 6	3,5	3,1/2 x 2,3/8	1,3/8



Piattino Bento quadrato bianco

Bento saucer, square white
Soucoupe Bento carré blanc
Platito Bento cuadrado blanco
Bento Untertasse, quadratisch, weiß

	Cm	H Cm	In	H In
305 21 54 706	9 x 9	2	3,1/2 x 3,1/2	0,3/4



Piattino Bento quadrato bianco

Bento saucer, square white
Soucoupe Bento carré blanc
Platito Bento cuadrado blanco
Bento Untertasse, quadratisch, weiß

	Cm	H Cm	In	H In
305 21 54 710	9 x 9	3,5	3,1/2 x 3,1/2	1,3/8



Coppetta Bento conica grigio/porpora

Bento small bowl, conical, grey/burgundy
Petit bol Bento conique gris/bordeaux
Bol pequeño Bento cónico gris/burdeos
Bento Schale, klein konisch, grau/burgund

	Ø Cm	H Cm	Ø In	H In
305 21 54 701	9	5	3,1/2	2



Coppetta Bento cilindrica grigio/porpora

Bento small bowl, cylindrical grey/burgundy
Petit bol Bento cylindrique gris/bordeaux
Bol pequeño Bento cilíndrico gris/burdeos
Bento Schale, klein, zylindrisch, grau/burgund

	Ø Cm	H Cm	Ø In	H In
305 21 54 703	5,5	3,5	2,1/8	1,3/8



Piattino Bento rettangolare grigio

Bento saucer, cylindrical grey
Soucoupe Bento cylindrique gris
Soucoupe Bento cilíndrico gris
Bento Untertasse zylindrisch, grau

	Cm	H Cm	In	H In
305 21 54 705	18 x 9	2	7 x 3,1/2	0,3/4



Piattino Bento rettangolare grigio

Bento saucer, rectangular grey
Soucoupe Bento rectangulaire gris
Platito Bento rectangular gris
Bento Untertasse rechteckig, grau

	Cm	H Cm	In	H In
305 21 54 707	9 x 6	3,5	3,1/2 x 2,3/8	1,3/8



Piattino Bento quadrato grigio

Bento saucer, square grey
Soucoupe Bento carré gris
Platito Bento cuadrado gris
Bento Untertasse quadratisch, grau

	Cm	H Cm	In	H In
305 21 54 709	9 x 9	2	3,1/2 x 3,1/2	0,3/4



Piattino Bento quadrato grigio

Bento saucer, square grey
Soucoupe Bento carré gris
Platito Bento cuadrado gris
Bento Untertasse quadratisch, grau

	Cm	H Cm	In	H In
305 21 54 711	9 x 9	3,5	3,1/2 x 3,1/2	1,3/8



1



Coppetta Bento conica grigio/porpora

Bento small bowl, conical, grey/burgundy
Petit bol Bento conique gris/bordeaux
Bol pequeño Bento cónico gris/burdeos
Bento Schale, klein konisch, grau/burgund

	Ø Cm	H Cm	Ø In	H In
305 21 54 701	9	5	3,1/2	2

2



Piattino Bento rettangolare grigio

Bento saucer, rectangular grey
Soucoupe Bento rectangulaire gris
Platito Bento rectangular gris
Bento Untertasse rechteckig, grau

	Cm	H Cm	In	H In
305 21 54 707	9 x 6	3,5	3,1/2 x 2,3/8	1,3/8

3



Piattino Bento quadrato grigio

Bento saucer, square grey
Soucoupe Bento carré gris
Platito Bento cuadrado gris
Bento Untertasse quadratisch, grau

	Cm	H Cm	In	H In
305 21 54 709	9 x 9	2	3,1/2 x 3,1/2	0,3/4

4



Piattino Bento quadrato grigio

Bento saucer, square grey
Soucoupe Bento carré gris
Platito Bento cuadrado gris
Bento Untertasse quadratisch, grau

	Cm	H Cm	In	H In
305 21 54 711	9 x 9	3,5	3,1/2 x 3,1/2	1,3/8

5



Piattino Bento rettangolare grigio

Bento saucer, cylindrical grey
Soucoupe Bento cylindrique gris
Soucoupe Bento cilíndrico gris
Bento Untertasse zylindrisch, grau

	Cm	H Cm	In	H In
305 21 54 705	18 x 9	2	7 x 3,1/2	0,3/4

6

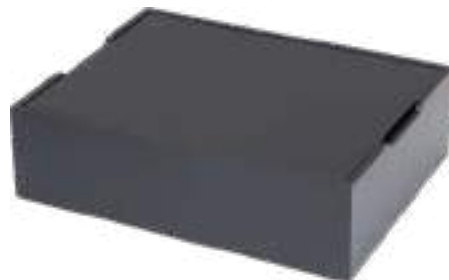

Bento box rettangolare, legno nero

Bento box, rectangular, black wood
Bento box rectangulaire, bois noir
Bento box rectangular, madera negra
Bento-Box, rechteckig, schwarzes Holz

	Cm interni	Cm esterni	H Cm
D10 00 00 695	24 x 18	27 x 20,5	7,5
	In interni	In esterni	H In
	9,1/2 x 7	10,5/8 x 8	3

Make your own Bento box

①



Vassoio quadrato per porcel. Bento

Tray, square, for Bento porcelain items
Plateau carré pour porcelaine Bento
bandeja cuadrada para porcelana Bento
Tablett, quadratisch, für Bento-Porzellanartikel

	Cm	In
305 05 23 904	18 x 18	7 x 7

②



Piattino Bento quadrato grigio

Bento saucer, square grey
Soucoupe Bento carré gris
Platito Bento cuadrado gris
Bento Untertasse quadratisch, grau

	Cm	H Cm	In	H In
305 21 54 709	9 x 9	2	3,1/2 x 3,1/2	0,3/4

③



Piattino Bento quadrato grigio

Bento saucer, square grey
Soucoupe Bento carré gris
Platito Bento cuadrado gri
Bento Untertasse quadratisch, grau

	Cm	H Cm	In	H In
305 21 54 711	9 x 9	3,5	3,1/2 x 3,1/2	1,3/8







PiGreco



Vassoio PiGreco quadrato in legno

PiGreco Square Tray
 Plateau carré PiGreco
 Bandeja cuadrada PiGreco
 Tablett, quadratisch, PiGreco

	Cm	In
319 04 23 875	40 x 40 x h.5	15/2 x 15/2 x h.2



Vassoio PiGreco Room Service

PiGreco Room Service Tray
 Plateau room-service PiGreco
 Bandeja room-service PiGreco
 Room-Service Tablett, PiGreco

	Cm	In
Nero - Black 319 04 23 874	60 x 40 x h.5	24/8 x 15/2 x h.2
Bianco - White 319 45 23 874	60 x 40 x h.5	24/8 x 15/2 x h.2



Vassoio rett. PiGreco Tea Time

PiGreco Rectangular Tea Time Tray
 Plateau rectangulaire Tea Time PiGreco
 Bandeja rectangular Tea Time PiGreco
 Time Tablett, rechteckig, PiGreco

	Cm	In
319 04 23 872	80 x 50 x h.5	31/2 x 19/2 x h.2
319 04 23 878	65 x 51 x h.5	25/8 x 20/8 x h.2



Pliant pieghevole in legno

Folding support for trays, wood
 Support pliant en bois pour plateau x
 Soporte plegable de madera para bandejas
 Faltbarer Tablettständer, Holz

	H Cm	H In
Nero - Black 319 04 23 882	50 x 36 x h.70	20 x 14 x h.28
319 04 23 892	50 x 36 x h.85	20 x 14 x h.34
Bianco - White 319 45 23 892	50 x 36 x h.85	20 x 14 x h.34



Vassoio quadrato noce

Square tray Walnut Wood
Plateau carré Noi x
Bandeja cuadrada Nogal
Quadratisches Tablett Walnussholz

	Cm	H Cm	In	H in.
305 04 23 848	40 x 40	5	15/2 x 15/2	2



Vassoio Room Service noce

Room-service tray Walnut Wood
Plateau Room Service Noi x
Bandeja Room Service Nogal
Zimmerservice-Tablett Walnussholz

	Cm	H Cm	In	H in.
305 04 23 849	60 x 40	5	24/8 x 15/2	2



Tovaglietta antiscivolo in ecopelle per vassoio

Artificial leather placemat for tray
Set de table peau artificielle pour plateau
Mantel individual piel sintética para bandeja
Kunstlerset für Tablett

	Cm	In
319 12 27 507	31 x 18	12 x 7/8
319 12 27 508	40 x 40	15/2 x 15/2
319 12 27 509	60 x 40	24/8 x 15/2
319 12 27 510	65 x 51	25/8 x 20/8
319 12 27 511	80 x 50	31/2 x 19/2



Pliant pieghevole, noce

Folding support for trays, Walnut Wood
Support pliant Noi x
Soporte plegable Nogal
Faltbarer Tablettständer, Walnussholz

	Cm	H Cm	In	H In
319 04 23 893	50 x 36	70	19,7 x 14,2	27,6





Vassoio tisane, 9 posti noce

Tea-selection tray, 9-compartment walnut wood

*Plateau à thé 9 compartements Noix**Bandeja para bolsitas de tè 9 plazas Nogal**Tee-Auswahltablett, 9 Fächer Walnussholz*

	Cm	H Cm	In	H in.
305 04 23 850	32 x 26	6	12,5/8 x 10,1/4	2,3/8

**Coprivassoio plexiglass per vassoio**

Acrylic tray cover for square tray

*Cloche acrylique pour plateau carré**Cúpula acrílica para bandeja cuadrada**Acryl Cover für rechteckiges Tablett*

	Cm	H Cm
305 12 53 648	37 x 37	18

per vassoio/for tray cm 39,5 x 39,5 - in 15,6 x 15,6

305 12 53 647	57 x 37	18
---------------	---------	----

per vassoio/ for tray 60 x 39,5Cm/ 26,6 x 15,6In

305 12 53 645	61,5 x 47,5	18
---------------	-------------	----

per vassoio/ for tray 64,5 x 50,5Cm/ 25,4 x 19,9In

VASSOIO VENDUTO SEPARATAMENTE
TRAY NOT INCLUDED**Portaposate da tavola PiGreco**

PiGreco Table Cutlery Stand

*Porte-couverts de table PiGreco**Posa cubiertos de mesa PiGreco**Tischbesteckhalter PiGreco*

	Cm	In
319 04 24 598	30,5 x 17,5 x h.4	12 x 6,7/8 x h.1,1/2

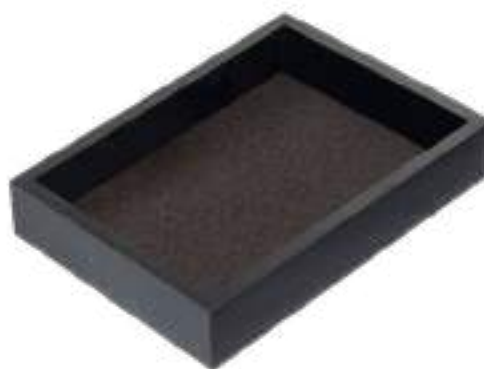
**Portaposate PiGreco, nero**

PiGreco cutlery holder, black

*Plateau à couverts PiGreco noir**Cubertero PiGreco negro**PiGreco Besteckkasten Schwarz*

	Cm	H Cm	In	H In
319 04 24 599	20 x 28	6,0	7,87 x 11	2,4



Alzata pasticceria 2 piani

Petit fours stand
 Plat à petits fours sur pied
 Petit Four Stand
 Soporte pasteles

Noce - Walnut

	H Cm	H In
305 54 42 671	24,2 x 23,5	12



Alzata pasticceria Noce

Cake stand, walnut
 Présentoir à gâteau x en bois de noyer
 Presentación tarta en madera de nogal
 Tortenplatte Walnussholz

Noce - Walnut

	Ø Cm	H Cm	Ø In	H In
305 54 42 692	16	9 Cm	6,1/4	3,1/2



Portapane Carasau Acciao Inox

Bread basket Essenza St. Steel
 Corbeille à pain en Acier Inox
 Cesta para pan en Acero Inox
 Brotkorb, Edelstahl

	Cm	In	H Cm	H In
305 05 24 606	13 x 11	5,1/8 x 4,3/8	9	3,1/2

Portapane - Noce

Bread basket, walnut
 Corbeille à pain noi x
 Cesta para pan nogal
 Brotkorb, Wallnuss

	Cm	In	H Cm	H In
305 54 24 604	15 x 15	5,7/8 x 5,7/8	3	1 x 1/8



Portagrissini - Noce

Breadsticks basket, walnut
 Corbeille à gressins noi x
 Cesta para pan nogal
 Grissini-Korb, Walnuss

	Cm	In	H Cm	H In
305 54 24 605	10 x 32	3,7/8 x 12,5/8	3	1 x 1/8



Cestino pane cotone écru

Bread basket, cotton, écru
 Corbeille à pain coton écru
 Cesta pan algodón color crudo
 Brotkorb Rohbaumwolle

	Cm	H Cm	In	H In
325 01 24 576	14 x 14	8	5,1/2 x 5,1/2	3,1/8
325 01 24 577	20 x 20	10	7,7/8 x 7,7/8	4



Cestino pane misto lino, beige

Bread basket, linen blend, beige grain
 Corbeille à pain médis, gros grain beige
 Cesta pan lino mezclado con algodón, grano beis
 Brotkorb Mischleinen Beige-Korn

	Cm	H Cm	In	H In
325 02 24 576	14 x 14	8	5,1/2 x 5,1/2	3,1/8
325 02 24 577	20 x 20	10	7,7/8 x 7,7/8	4



Cestino pane cotone, grana nera

Bread basket, cotton, black grain
 Corbeille à pain coton, gros grain noir
 Cesta pan algodón, grano negro
 Brotkorb Baumwolle Schwarz Korn

	Cm	H Cm	In	H In
325 03 24 576	14 x 14	8	5,1/2 x 5,1/2	3,1/8
325 03 24 577	20 x 20	10	7,7/8 x 7,7/8	4





Cuscino termico

Thermal cushion
 Coussin chauffant
 Cojín térmico
 Wärme Kisse

	Cm	In
Piccolo - Small		
325 05 24 579	12,5 x 12,5	5 x 5
Grande - Large		
325 05 24 580	18 x 18	7 x 7



Cestino pane tessuto

Bread basket
 Corbeille à pain
 Cesta pan
 Stoff Brotkorb

	Cm	In
Marrone - Brown		
305 29 24 581	12,5 x 12,5	5 x 5
305 29 24 582	18 x 18	7 x 7
Beige - Beige		
305 29 24 583	12,5 x 12,5	5 x 5
305 29 24 584	18 x 18	7 x 7

Decò



Lampada Decò marmo nero

Decò Lamp, black marble

*Decò Lamp, marbre noire**Decò Lámpara, mármol negro**Decò Lampe, Schwarzer Marmor*

	Ø Cm	H Cm	In	H In
414 02 17 101	13	25,5	5,1/8	10

**Lampada Decò marmo bianco**

Decò Lamp, white marble

*Decò Lamp, marbre blanc**Decò Lámpara, mármol blanco**Decò Lampe, Weißer Marmor*

	Ø Cm	H Cm	In	H In
414 01 17 101	13	25,5	5,1/8	10





Venus

Lampada Venus cemento

Venus Lamp, cement

Venus Lamp, ciment

Venus Lámpara, cemento

Venus Lampe, Zement

	Ø Cm	H Cm	In	H In
414 01 17 102	13	27,5	5,1/8	10,7/8



Bugia



Lampada Bugia ricaricabile Antracite

Bugia rechargeable lamp, grey

*Lampe Bugia anthracite**Lámpara Bugia antracita**Lampe Bugia, anthrazit*

	Cm	H Cm	In	H in.	
414 02 17 001	8 x 8	32	3,1/8 x 3,1/8	12,5/8	

**Lampada Bugia ricaricabile Bianco**

Bugia rechargeable lamp, white

*Lampe Bugia blanche**Lámpara Bugia blanca**Lampe Bugia, weiß*

	Cm	H Cm	In	H in.	
414 01 17 001	8 x 8	32	3,1/8 x 3,1/8	12,5/8	

**Lampada Bugia ricaricabile Cromata**

Bugia rechargeable lamp, chromed

*Lampe Bugia chromé**Lámpara Bugia cromado**Lampe Bugia, verchromt*

	Cm	H Cm	In	H in.	
414 05 17 001	8 x 8	32	3,1/8 x 3,1/8	12,5/8	

**Lampada Bugia ricaricabile Corten**

Bugia rechargeable lamp, corten

*Lampe Bugia corten**Lámpara Bugia corten**Lampe Bugia, corton*

	Cm	H Cm	In	H in.	
414 03 17 001	8 x 8	32	3,1/8 x 3,1/8	12,5/8	



A warm, inviting interior scene. In the background, a fireplace with a grey stone surround contains a fire of logs. In the foreground, a rustic wooden table holds a modern lamp with a thin stem and a black circular shade, and several glasses of drinks. A wooden chair is partially visible on the left.

Nuvola

Lampada Nuvola, antracite

Nuvola lamp, anthracite
Lampe Nuvola anthracite
Lámpara Nuvola antracita
Lampe Resort, weiß

	base Ø Cm	diffuser Cm	H Cm
411 02 17 001	10	12	31



Lampada Nuvola, bianca

Nuvola lamp, white
Lampe Nuvola blanche
Lámpara Nuvola blanca
Lampe Nuvola, weiß

	base Ø Cm	diffuser Cm	H Cm
411 01 17 001	10	12	31



Lampada Nuvola, acciaio

Nuvola lamp, chromed
Lampe Nuvola chromé
Lámpara Nuvola cromado
Lampe Nuvola, verchromt

	base Ø Cm	diffuser Cm	H Cm
411 05 17 001	10	12	31



Lampada Nuvola, corten

Nuvola lamp, corten
Lampe Nuvola corten
Lámpara Nuvola corten
Lampe Nuvola, corton

	base Ø Cm	diffuser Cm	H Cm
411 03 17 001	10	12	31



Accessori

Base lampade Decò/Venus/Resort 6 pos.

Decò/Venus/Resort lamp base 6 pos.

Inclusi 4 distanziali / Spacer set 4-pc included

	LxP cm	H Cm
910 04 23 006	53 x 33	56



Vassoio portalampe Nuvola 8 posizioni

Nuvola lamp-holder tray, 8-compartment

411 04 23 001



Multipresa USB per Decò, Venus, Bugia, Nuvola, Resort, 12 posizioni

USB multisocket for Decò, Venus, Bugia, Nuvola, Resort, 12 position

411 99 81 503



Base lampade Bugia/Nuvola 12 pos. senza multipresa

Bugia/nuvola lamp base 12 pos. w/out multisocket

	LxP cm	H Cm
910 04 23 003	66 x 48	5





Gennaro



Espositore piccola pasticceria

Petits fours display
 Présentoir à petits fours
 Soporte para pasteles
 Ständer für kleine Gebäcke



	Ø mm	H mm	Ø In	H In	N. Fori/holes
607 N0 71 933	490	423	19,1/4	16,1/2	60
607 P0 68 115	340	300	13,3/8	11,3/4	32
607 P0 68 117	165	145	6,1/2	6,1/2	9

Paletta pasticceria Acciaio Inox

Server for petit fours small St.Steel
 Petite pelle à petits fours Acier Inox
 Pala pequeña para pastelitos Acero Inox
 Gebäckzange, Edelstahl

	Cm	In
3050581708	5	2
3050581711 con piega	3,7 x 9	1,5/8 x 3,1/2

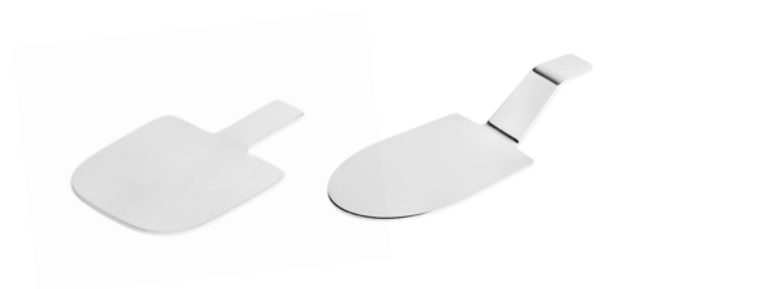



Aqva



Distributore bevande riscaldato

Heated beverage dispenser

Distributeur de boissons chauffé

Dispensador de bebidas calentado

Getränkespender, aufgewärmt

	Lt	Oz	H Cm	H In
305 05 52 708	5	169	80	31,1/2



Samovar riscaldato

Heated Samovar

Samovar chauffé

Samovar calentado

Samovar aufgewärmt

	Lt	Oz
305 05 52 707	5 + 1	169 + 35

Teiera in vetro / Glass teapot

305 08 02 580	1	35
---------------	---	----



❶ Regolatore di temperatura (dai 45°C ai 95°C)
Temperature regulator (from 45°C to 95°C)

❷ Tasto ON - OFF
ON-OFF button

❸ Spie luminose/Spie luminose:
 ● temperatura resistenza >80°C
temperature of the resistance is > di 80°
 ● il livello del liquido è sotto al minimo
level of liquid is below minimum
 ● lampeggiante - il liquido è in fase di riscaldamento
flashing: the liquid heating up
 ● fisso - il liquido ha raggiunto la temperatura desiderata
fixed: it has reached the temperature set on the control knob

Distributore Aqva con base in marmo di Carrara

Aqva dispenser with Carrara marble stand
 Distributeur Aqva avec support en Carrara marbre
 Dispensador Aqva con soporte en Carrara mármol
 Getränkespender Aqva mit Ständer aus Carrara Marmor

Marmo di Carrara e vetro - Carrara Marble and glass

	Lt	Oz	H Cm	H In
305 54 52 729	5	169	63	24.8

Il nostro **AQVA** è innovativo, per il suo design elegante ed originale e perché permette, grazie alla doppia parete, di avere una lentissima dispersione della temperatura del liquido interno.

Our **AQVA** is innovative for having an elegant and original design and because it allows, thanks to the double wall, to have an extremely low temperature dispersion of the inside liquid.



FREDDO

Mantenimento della temperatura delle bevande per 5/6 ore senza bisogno di fonti refrigeranti. Test effettuati ad una temperatura ambiente di 20°C (68°F)

COLD

Maintenance of drinks temperature for 5/6 hours without cooling element. Test carried out at 20°C (68°F) room temperature.

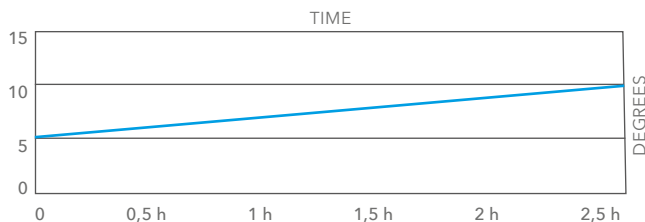

CALDO

Mantenimento della temperatura della bevanda per 4/5 ore senza bisogno di fonti di calore

HOT

Maintenance of drinks temperature for 4/5 hours without heating element.

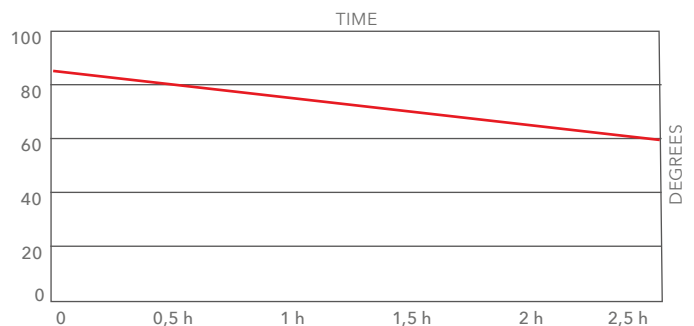

Distributore Aqva con alzata Nature

Aqva dispenser with Nature stand
 Distributeur Aqva avec support Nature
 Dispensador Aqva con soporte Nature
 Aqua Getränkespender mit Ständer Nature

	Lt	Oz	Cm	H Cm	In	H in
305 44 52 711	5	169	26 x 26	38	10,1/4 x 10,1/4	31,1/2
nero/black						



Distributore Aqva con base in noce

Aqva dispenser with walnut wood stand
 Distributeur Aqva avec support en bois de noyer
 Dispensador Aqva con soporte en madera de nogal
 Getränkespender Aqva mit Ständer aus Walnussholz
 Noce e vetro - Walnut and glass

	Lt	Oz	H Cm	H In
305 54 52 728	5	169	63	24.8





Distributore Aqva con alzata Classica

Aqva dispenser with Classica stand

Distributeur Aqva avec support Classica

Dispensador Aqva con soporte Classica

Aqua Getränkespender mit Ständer Classica

	Lt	Oz	Ø Cm	H Cm	Ø In	H in
305 55 52 712	5	169	27	80	10,5/8	31,1/2
cromato/chromed						

305 07 52 712	5	169	27	80	10,5/8	31,1/2
acciaio argentato/electro-plated stainless steel (EPSS)						



Distributore bevande caldo/freddo

Hot and cold beverage dispenser

Distributeur de boissons chaud/froid

Dispensador de bebidas caliente/frío

Getränkespender warm/kalt

	Lt	Oz	H Cm	H In
305 05 52 709	5	169	80	31,1/2





Buffet





Decò



Cubo Decò

Decò cube
Cube Decò
Cubo Decò
Decò Würfel

ACCIAIO - St. steel

	base Cm	H Cm	base in.	H in.
326 05 42 001	15 x 15	15,0	5,9 x 5,9	5,9
326 05 42 002	20 x 20	20,0	7,9 x 7,9	7,9
326 05 42 003	25 x 25	25,0	9,8 x 9,8	9,8

ACCIAIO DORATO - Gilded st. steel

	base Cm	H Cm	base in.	H in.
326 28 42 001	15 x 15	15,0	5,9 x 5,9	5,9
326 28 42 002	20 x 20	20,0	7,9 x 7,9	7,9
326 28 42 003	25 x 25	25,0	9,8 x 9,8	9,8

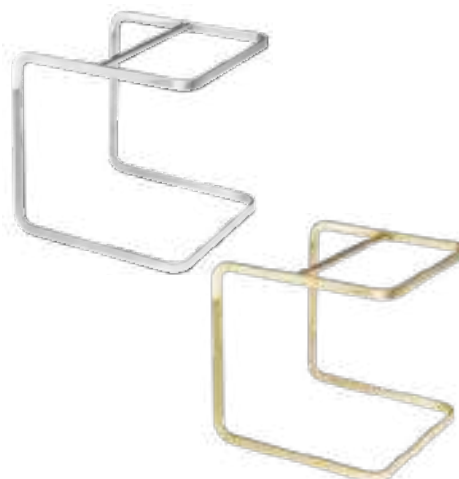

Piano Decò, quadrato

Decò top, square
Dessus Decò carré
Tablero Decò cuadrado
Platte Decò quadrat

MARMO DI CARRARA - Carrara marble

	base Cm	H Cm	base in.	H in.
326 22 42 001	15 x 15	1,2	5,9 x 5,9	0,5
326 22 42 002	20 x 20	1,2	7,9 x 7,9	0,5
326 22 42 003	25 x 25	1,2	9,8 x 9,8	0,5

HPL

	base Cm	H Cm	base in.	H In
326 64 42 001	15 x 15	1,2	5,9 x 5,9	0,5
326 64 42 002	20 x 20	1,2	7,9 x 7,9	0,5
326 64 42 003	25 x 25	1,2	9,8 x 9,8	0,5

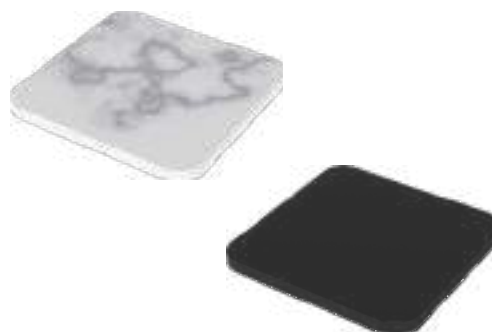

Piano Decò, rettangolare

Decò top, rectangular
Dessus Decò rectangulaire
Tablero Decò rectangular
Platte Decò rechteckig

MARMO DI CARRARA - Carrara marble

	base Cm	H Cm	base in.	H In
326 22 42 004	15 x 50	1,2	5,9 x 19,7	0,5
326 22 42 005	20 x 60	1,2	7,9 x 23,6	0,5
326 22 42 006	25 x 70	1,2	9,8 x 27,6	0,5

HPL

	base Cm	H Cm	base in.	H In
326 64 42 004	15 x 50	1,2	5,9 x 19,7	0,5
326 64 42 005	20 x 60	1,2	7,9 x 23,6	0,5
326 64 42 006	25 x 70	1,2	9,8 x 27,6	0,5



Cilindro Decò

Decò cylinder
Cylindre Decò
Cilindro Decò
Decò Zylinder

ACCIAIO - St. steel

	base Ø Cm	H Cm	base Ø in.	H in
326 05 42 004	20	15	7,9	5,9
326 05 42 005	20	25	7,9	9,8

ACCIAIO DORATO - Gilded st. steel

	base Ø Cm	H Cm	base Ø in.	H in
326 28 42 004	20	15	7,9	5,9
326 28 42 005	20	25	7,9	9,8



Piano Decò, tondo

Decò top, square
Dessus Decò ronde
Tablero Decò redondo
Platte Decò runden

MARMO DI CARRARA - Carrara marble

	base Ø Cm	H Cm	base in.	H In
326 22 42 009	20	1,2	7,9	0,5

HPL

	base Ø Cm	H Cm	base in.	H In
326 64 42 009	20	1,2	7,9	0,5



Cestino pane Decò su alzata tonda

Decò bread basket on round standl
Corbeille à pain Decò sur support rond
Cesta pan Decò sobre soporte redondo
Brotkorb Decò, rund

ACCIAIO - St. steel

	Ø Cm	H Cm	In	H In
326 05 24 010	20	15	7,9	5,9
326 05 24 011	20	25	7,9	9,8

ACCIAIO DORATO - Gilded st. steel

	Ø Cm	H Cm	In	H In
326 28 24 010	20	15	7,9	5,9
326 28 24 011	20	25	7,9	9,8





Distributore vetro doppio corpo

Dispenser, glass, double-wall
 Distributeur verre double parois
 Dispensador cristal doble pared
 Spender, Glas, doppelwandig

ACCIAIO/MARMO - chromed/Marble

	Lt	Oz
326 05 52 003	2,5	84,5

ACCIAIO/HPL - chromed/HPL

	Lt	Oz
326 05 52 004	2,5	84,5

**Distributore vetro doppio corpo**

Dispenser, glass, double-wall
 Distributeur verre double parois
 Dispensador cristal doble pared
 Spender, Glas, doppelwandig

DORATO/MARMO - gilded/Marble

	Lt	Oz
326 28 52 003	2,5	84,5

DORATO/HPL - gilded/HPL

	Lt	Oz
326 28 52 004	2,5	84,5





Distributore succhi Decò

Decò juice dispenser
 Distributeur de jus Decò
 Dispensador zumo Decò
 Müslispender Decò;

ACCIAIO/MARMO - steel/Marble

	Lt	Oz
326 05 52 005	8	270,5

ACCIAIO/HPL - steel/HPL

	Lt	Oz
326 05 52 006	8	270,5

**Distributore succhi Decò**

Decò juice dispenser
 Distributeur de jus Decò
 Dispensador zumo Decò
 Müslispender Decò;

DORATO/MARMO - gilded/Marble

	Lt	Oz
326 28 52 005	8	270,5

DORATO/HPL - gilded/HPL

	Lt	Oz
326 28 52 006	8	270,5



Distributore cereali Decò

Decò cereal dispenser
 Distributeur céréales Decò
 Dispensador cereales Decò
 Müslispender Decò

ACCIAIO/MARMO - chromed/Marble

	Lt	Oz
326 05 52 001	3	101

ACCIAIO/HPL - chromed/HPL

	Lt	Oz
326 05 52 002	3	101



Distributore cereali Decò

Decò cereal dispenser
 Distributeur céréales Decò
 Dispensador cereales Decò
 Müslispender Decò

DORATO/MARMO - gilded/Marble

	Lt	Oz
326 28 52 001	3	101

DORATO/HPL - gilded/HPL

	Lt	Oz
326 28 52 002	3	101

Distributore caffè Decò

Decò coffee urn
 Distributeur de café
 Dispensador café
 Kaffespender Decò

ACCIAIO/MARMO - chromed/Marble

	Lt	Oz
326 05 52 007	7	236,7
326 05 52 009	10	338,1

ACCIAIO/HPL - chromed/HPL

	Lt	Oz
326 05 52 008	7	236,7
326 05 52 010	10	338,1

**Distributore caffè Decò**

Decò coffee urn
 Distributeur de café
 Dispensador café
 Kaffespender Decò

DORATO/MARMO - gilded/Marble

	Lt	Oz
326 28 52 007	7	236,7
326 28 52 009	10	338,1

DORATO/HPL - gilded/HPL

	Lt	Oz
326 28 52 008	7	236,7
326 28 52 010	10	338,1

**Piastra elettrica scalda-caffè**

Coffee-warmer electric plate
 Plaque chauffante électrique à café
 Placa eléctrica calientacafé
 Kaffeewärmer mit elektrischer Platte

305 05 52 576





Porta yogurt/macedonia refrigerato Decò

Refrigerated fruit salad/yogurt holder Decò
 Porte-salades de fruits/yaourt réfrigéré Decò
 Porta macedonia/yogur refrigerado Decò
 Kühler Obstsalat-/Joghurt-Halter Decò

		Lt	Oz	H Cm	H In
Acciaio/HPL Chromed/HPL	326 05 52 012	3	105	30	11 3/4
Dorato/HPL Gilded/HPL	326 28 52 012	3	105	30	11 3/4
Acciaio/Marmo Chromed/Marble	326 05 52 013	3	105	30	11 3/4
Dorato/Marmo Gilded/Marble	326 28 52 013	3	105	30	11 3/4

**Porta cereali Decò**

Cereal holder Decò
 Porte-céréales Decò
 Porta cereales Decò
 Müslispender Decò

		Lt	Oz	H Cm	H In
Acciaio Chromed	326 05 52 015	3	105	21	8.2
Dorato Gilded	326 28 52 015	3	105	21	8.2
Acciaio Chromed	326 05 52 016	3	105	29	11 1/2
Dorato Gilded	326 28 52 016	3	105	29	11 1/2







Vassoio ringhiera in filo di acciaio Decò

Decò tray with railing steel wire

Plateau Decò avec rambarde en acier

Bandeja Decò con barandilla en acero

Platte Decò mit Edelstahlreling

FILO DI ACCIAIO - Railing steel wire

	Cm	H Cm	In	H In
326 05 23 010	40 x 40	7	15,3/4 x 15,3/4	2,3/4
326 05 23 011	60 x 40	7	23,5/8 x 15,3/4	2,3/4

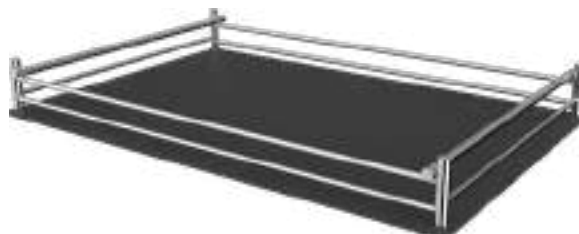

FILO DI ACCIAIO DORATO - Railing gilded steel wire

	Cm	H Cm	In	H In
326 28 23 010	40 x 40	7	15,3/4 x 15,3/4	2,3/4
326 28 23 011	60 x 40	7	23,5/8 x 15,3/4	2,3/4

FILO DI ACCIAIO CON PANNINO - Steel wire railing and fabric

	Cm	H Cm	In	H In
326 05 23 012	60 x 40	7	23,5/8 x 15,3/4	2,3/4



FILO DI ACCIAIO DORATO CON PANNINO

Gilded steel wire railing and fabric

	Cm	H Cm	In	H In
326 28 23 012	60 x 40	7	23,5/8 x 15,3/4	2,3/4





N.3 CARAFFE INCLUSE
N.3 INCLUDED PITCHERS

Portacaraffe refrigerato Decò

Decò jug stand, refrigerated
Support pour carafes Decò réfrigéré
Soporte para jarras Decò refrigerado
Flaschenhalter Decò, gekühlt

ACCIAIO - St.steel

	Cm	H Cm	In	H In
326 05 24 001	52,5 x 20	9	20,5/8 x 7,7/8	3,1/2

ACCIAIO DORATO - Gilded st.steel

	Cm	H Cm	In	H In
326 28 24 001	52,5 x 20	9	20,5/8 x 7,7/8	3,1/2



Barella Decò

Tray
Plateau
Bandeja
Tablett

CON PIANO IN HPL - HPL top

	Cm	H Cm	In	H In
326 05 23 001	52,5 x 20	5	20,5/8 x 7,7/8	2

CON PIANO IN HPL DORATO - HPL top, gilded

	Cm	H Cm	In	H In
326 28 23 001	52,5 x 20	5	20,5/8 x 7,7/8	2



Supporto alto per ciotole

bowl stand, high
Support pour bols haut
Soporte para boles alto
Schüsselständer, hoch

ACCIAIO - St.steel

	Cm	H Cm	In	H In
326 05 42 011	52,5 x 20	20	20,5/8 x 7,7/8	7,7/8

ACCIAIO DORATO - Gilded st.steel

	Cm	H Cm	In	H In
326 28 42 011	52,5 x 20	20	20,5/8 x 7,7/8	7,7/8

Ciotole artesano o ciotole urban non incluse
 Artesano bowls or urban bowls not included

**Supporto alto per vasi**

Jar stand, hig
Support pour pots en verre haut
Soporte para jarrones de cristal alto
Glasständer, hoch

ACCIAIO - St.steel

	Cm	H Cm	In	H In
326 05 42 010	52,5 x 20	20	20,5/8 x 7,7/8	7,7/8

ACCIAIO DORATO - Gilded st.steel

	Cm	H Cm	In	H In
326 28 42 010	52,5 x 20	20	20,5/8 x 7,7/8	7,7/8

Vasi in vetro non inclusi / Glass jars with lid not included

**Supporto medio per ciotole**

bowl stand, medium
Support pour bols moyen
Soporte para boles mediano
Schüsselständer, mittel

ACCIAIO - St.steel

	Cm	H Cm	In	H In
326 05 42 013	52,5 x 20	13,5	20,5/8 x 7,7/8	5,3/8

ACCIAIO DORATO - Gilded st.steel

	Cm	H Cm	In	H In
326 28 42 013	52,5 x 20	13,5	20,5/8 x 7,7/8	5,3/8

Ciotole artesano o ciotole urban non incluse
 Artesano bowls or urban bowls not included

**Supporto medio per vasi**

Jar stand, medium
Support pour pots en verre moyen
Soporte para jarrones de cristal mediano
Glasständer, mittel

ACCIAIO - St.steel

	Cm	H Cm	In	H In
326 05 42 012	52,5 x 20	13,5	20,5/8 x 7,7/8	5,3/8

ACCIAIO DORATO - Gilded st.steel

	Cm	H Cm	In	H In
326 28 42 012	52,5 x 20	13,5	20,5/8 x 7,7/8	5,3/8

Vasi in vetro non inclusi / Glass jars with lid not included







Alzata scaffale 2 piani Decò

Decò 2-shelf stand

Etagère Decò 2 étages

Estante Decò 2 estantes Regalständer

Decò mit 2 Böden

ACCIAIO/HPL - Chromed/hpl

	Cm	H Cm	In	H In
326 05 42 020	15 x 50	25,5	6 x 19,7/8	10
326 05 42 021	20 x 60	25,5	7,7/8 x 23 5/8	10



ACCIAIO/MARMO - Chromed/marble

	Cm	H Cm	In	H In
326 05 42 022	15 x 50	25,5	6 x 19,7/8	10
326 05 42 023	20 x 60	25,5	7,7/8 x 23 5/8	10



DORATO/HPL - Gilded/hpl

	Cm	H Cm	In	H In
326 28 42 020	15 x 50	25,5	6 x 19,7/8	10
326 28 42 021	20 x 60	25,5	7,7/8 x 23 5/8	10



DORATO/MARMO - gilded/marble

	Cm	H Cm	In	H In
326 28 42 022	15 x 50	25,5	6 x 19,7/8	10
326 28 42 023	20 x 60	25,5	7,7/8 x 23 5/8	10



Portaformaggi refrigerato con bascula Decò

Decò cheese dish, thermal with roll-top cover
 Plateau à fromage réfrigéré Decò avec bascule
 Porta queso refrigerado Decò con bascula
 Käseplatte Decò, gekühlt mit Rolltop-Cover,

ACCIAIO - St.steel

	Cm	In
326 05 54 002	52 x 32	20,1/2 x 12,5/8

ACCIAIO DORATO - Gilded st.steel

	Cm	In
326 28 54 002	52 x 32	20,1/2 x 12,5/8



Vassoio formaggi refrigerato Decò

Decò cheese tray, thermal
 Plateau à fromage réfrigéré Decò
 Bandeja queso refrigerado Decò
 Käseplatte Decò, gekühlt

ACCIAIO - St.steel

	Cm	In
326 05 54 001	52 x 32	20,1/2 x 12,5/8

ACCIAIO DORATO - Gilded st.steel

	Cm	In
326 28 54 001	52 x 32	20,1/2 x 12,5/8





Nature Buffet



Nature

Alzata torta in noce bassa

Cake stand, walnut

Présentoir à gâteau x en bois de noyer

Presentación tarta en madera de nogal

Tortenplatte Walnussholz

Noce - Walnut

	Ø Cm	Ø In	H Cm	H In
305 54 42 673 (small)	28	11	14	5,5
305 54 42 674 (medium)	33	12,9	14	5,5
305 54 42 675 (large)	37	14,5	14	5,5



Alzata torta in noce alta

Cake stand, walnut

Présentoir à gâteau x en bois de noyer

Presentación tarta en madera de nogal

Tortenplatte Walnussholz

Noce - Walnut

	Ø Cm	Ø In	H Cm	H In
305 54 42 676 (small)	28	11	21	8,2
305 54 42 677 (medium)	33	12,9	21	8,2
305 54 42 678 (large)	37	14,5	21	8,2



**Coperchio a bascula
adatto per alzate Ø37Cm
suitable for stands Ø37Cm**

Transparent round rolltop cover
Cloche basculante ronde transparente
Rolltophaube - rund
Campana redonda transparente

SAN

	Ø Cm	Ø In
V76 12 15 T01	34	13,3/8



**Cupola in vetro
adatto per alzate Ø28Cm
suitable for stands Ø28Cm**

Dome cover, glass
Cloche en verre
Campana de vidrio
Cloche aus Glas

Vetro - Glass

	Ø Cm	Ø In
404 10 42 610	25	9,8



**Cupola in policarbonato
adatto per alzate Ø28Cm
suitable for stands Ø28Cm**

Dome cover, acrylic
Cloche en acrylique
Campana de acrilico
Cloche aus Polycarbonat

Policarbonato - Polycarbonat

	Ø Cm	Ø In
305 12 53 625	26	10,2





Alzata torta refrigerata in noce

Refrigerated walnut cake stand
Présentoir à gâteau réfrigéré en noyer
 Soporte para tarta refrigerado en nogal
 Kühler Tortenständer aus Walnussholz

	Ø Cm	Ø In	H Cm	H In
305 54 42 693	36	14,1/8	18	7
305 54 42 694	36	14,1/8	25	9,7/8

cloche non inclusa / cloche not included



**Coperchio a bascula
 adatto per alzate Ø37Cm
 suitable for stands Ø37Cm**

Transparent round rolltop cover
Cloche basculante ronde transparente
 Rolltophaube - rund
 Campana redonda transparente

SAN

	Ø Cm	Ø In
V76 12 15 T01	34	13,3/8



Nature

Alzata pasticceria Noce

Cake stand, walnut
 Présentoir à gâteau x en bois de noyer
 Soporte pasteles en madera de nogal
 Tortenplatte Walnussholz

Noce - Walnut

	Ø Cm	H Cm	Ø In	H In
305 54 42 692	16	9 Cm	6,1/4	3,1/2



Alzata pasticceria 2 piani

Petit fours stand
 Plat à petits fours sur pied
 Petit Four Stand
 Soporte pasteles

Noce - Walnut

	H Cm	H In
305 54 42 671 (2 posti)	23,5 x 24,4	12



Alzata pasticceria 3 piani

Petit fours stand
 Plat à petits fours sur pied
 Petit Four Stand
 Soporte pasteles

Noce - Walnut

	H Cm	H In
305 54 42 670 (3 posti)	43 x 41,5	12



Piattino rettangolare

Rectangular plate - Plato rectangular
 Plat rectangulaire - Rechteckige Teeller

Porcellana - Porcelain

	Cm	In
264 00 42 669	18 x 11	7 x 4,3



Ciotolina a goccia

Bowl - Bol
 Bol - Schüssel

Porcellana - Porcelain

	Cm	In
V87 21 42 001	8 x 7 x 4	3,1 x 1,5



Piattino quadrato porcellana

Square saucer - Platillo cuadrado
 Soucoupe carrée - Quadratische teller

Porcellana - Porcelain

	Cm	In
322 21 22 691	10 x 10	3,9 x 3,9



Coppetta rotonda

Round bowl - Bol redondo
 Bol rond - Runde Schüssel

Porcellana - Porcelain

	Ø Cm	Ø In
V87 21 42 005	7	2,7





Distributore Aqva con alzata Nature

Aqva dispenser with Nature stand

Distributeur Aqva avec support Nature

Dispensador Aqva con soporte Nature

Aqua Getränkespender mit Ständer Nature

	Cm	H Cm	In	H In
305 44 52 711	26 x 26	10,1/4 x 10,1/4	38	31,1/2
nero/black				

305 05 52 711	26 x 26	10,1/4 x 10,1/4	38	31,1/2
cromato/chromed				

Distributore Aqva con base in noce

Aqva dispenser with walnut wood stand

Distributeur Aqva avec support en bois de noyer

Dispensador Aqva con soporte en madera de nogal

Getränkspender Aqva mit Ständer aus Walnussholz

Noce e vetro - Walnut and glass

	H Cm	H In
305 54 52 728	63	24.8







Nature



Piano in noce massello

Solid walnut wood top
Dessus en bois massif noyer
Tabla de madera maciza de nogal
Top Walnuss massiv

	Cm	In
305 54 42 629	30 x 30	11,3/4 x 11,3/4
305 54 42 630	70 x 30	27,1/2 x 11,3/4
305 54 42 631	100 x 30	39,3/8 x 11,3/4



Piano in ardesia

Slate top
Dessus en ardoise
Tabla de pizarra
Top Schiefer

	Cm	In
V87 09 42 Q01	30 x 30	11,3/4 x 11,3/4
V87 09 42 R01	70 x 30	27,1/2 x 11,3/4
V87 09 42 R02	100 x 30	39,3/8 x 11,3/4



Piano in pietra lavica

Lava top
Dessus en pierre de lave
Tabla de piedra lávica
Top Lavastein

	Cm	In
305 60 42 633	30 x 30	11,3/4 x 11,3/4
305 60 42 634	70 x 30	27,1/2 x 11,3/4
305 60 42 635	100 x 30	39,3/8 x 11,3/4



Vassoio per alzate rettangolare

Tray for podia, rectangular
 Plateau pour supports rectangulaire
 Bandeja rectangular para soportes
 Tablett Walnuss, rechtekig

Noce - Walnut

	Cm	H Cm	In	H In
305 54 23 854	35 x 52,5	4,5	13,3/4 x 20,5/8	1,3/4

**Vassoio per alzate rettangolare**

Tray for podia, rectangular
 Plateau pour supports rectangulaire
 Bandeja rectangular para soportes
 Tablett Walnuss, rechtekig

Noce - Walnut

	Cm	H Cm	In	H In
305 54 23 855	35 x 52,5	8	13,3/4 x 20,5/8	3,1/8

**Vassoio per alzate rettangolare**

Tray for podia, rectangular
 Plateau pour supports rectangulaire
 Bandeja rectangular para soportes
 Tablett Walnuss, rechtekig

Noce - Walnut

	Cm	H Cm	In	H In
305 54 23 853	17,5 x 52,5	4,5	6,7/8 x 20,5/8	1,3/4

**Vassoio alzata Nature in legno**

Nature tray, walnut wood
 Plateau Nature en bois noyer
 Bandeja Nature en madera de nogal
 Tablett Walnuss rechtekig

	Cm	H Cm	In	H In
305 54 23 886	26 x 35	4,5	10,2 x 13,8	1,3/4

**Base inclinata per vassoi**

Inclined base for rectangular trays
 Base inclinée pour plateau x rectangulair
 Base inclinada para bandejas
 Basistablett mit Kante rechtekig

Noce - Walnut

	Cm	H Cm	In	H In
305 54 23 856	35 x 52,5	6,7	13,3/4 x 20,5/8	2,1/2



Nature

Alzata quadrata nera opaca

Square podium
Support carré
Soporte cuadrado
Podest quadratisch

NERA OPACA - matte black

	Cm	H Cm	In	H In
305 44 42 621	18 x 18	20	7 x 7	7,7/8
305 44 42 622	18 x 18	25	7 x 7	9,7/8
305 44 42 623	18 x 18	30	7 x 7	11,3/4



Alzata rettangolare

Rectangular podium
Support rectangulaire
Soporte rectangular
Podest rechteckig

NERA OPACA - matte black

	Cm	H Cm	In	H In
305 44 42 625	17,5 x 52,5	13,5	6,7/8 x 20,5/8	5,3/4
305 44 42 626	17,5 x 52,5	20	6,7/8 x 20,5/8	7,7/8



Alzata rettangolare

Rectangular podium
Support rectangulaire
Soporte rectangular
Podest rechteckig

NERA OPACA - matte black

	Cm	H Cm	In	H In
305 44 42 627	35 x 52,5	13,5	13,3/4 x 20,5/8	5,3/4
305 44 42 628	35 x 52,5	20	13,3/4 x 20,5/8	7,7/8

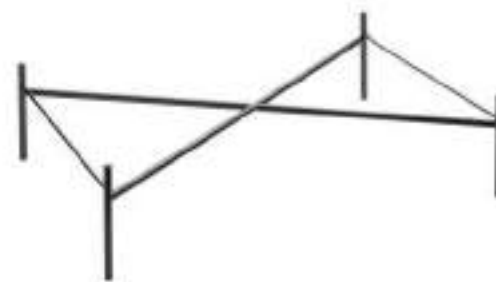

Alzata rettangolare per porcellane

Rectangular podium for porcelain items
Support rectangulaire pour articles en porcelaine
Soporte rectangular para artículos de porcelana
Podest rechteckig für Artikel aus Porzellan

NERA OPACA - matte black

	Cm	H Cm	In	H
305 44 42 624	12 x 40	13,5	4,3/4 x 15,3/4	5,3/4
305 44 42 632	12 x 40	20	4,3/4 x 15,3/4	7,7/8

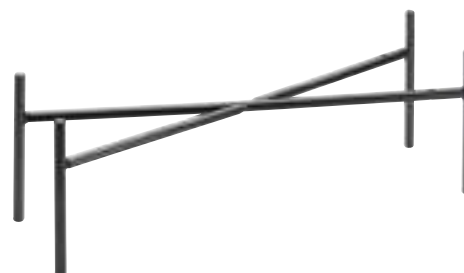



Cestino pane per alzata quadrata

Bread basket for square podium
 Corbeille à pain pour support carré
 Cesta para pan para soporte cuadrado
 Brotkorb für Podium quadratisch

Misto lino - Linen blend

	Cm	H Cm	In	H In
305 29 24 588	18 x 18	20	7 x 7	7,7/8



Alzata quadrata nera opaca

Matte black square podium
 Support carré noir
 Soporte cuadrado negro mate
 Podest quadratisch Schwarz

	Cm	H Cm	In	H In
305 44 42 621	18 x 18	20	7 x 7	7,7/8
305 44 42 622	18 x 18	25	7 x 7	9,7/8
305 44 42 623	18 x 18	30	7 x 7	11,3/4

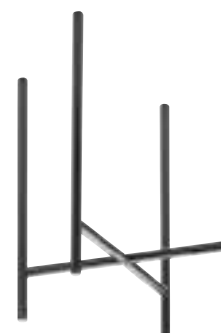

Cestino pane per alzata rettangolare

Bread basket for rectangular podium
 Corbeille à pain pour support rectangulaire
 Cesta para pan para soporte rectangular
 Brotkorb für Podium rechteckig Cm

Misto lino - Linen blend

	Cm	H Cm	In	H In
305 29 24 589	17,5 x 52,5	13,5	6,7/8 x 20,5/8	5,3/4
305 29 24 590	17,5 x 52,5	20	6,7/8 x 20,5/8	7,7/8



Alzata rettangolare nera opaca

Matt black rectangular podium
 Support rectangulaire noir
 Soporte rectangular negro mate
 Podest rechteckig Schwarz

	Cm	H Cm	In	H In
305 44 42 625	17,5 x 52,5	13,5	6,7/8 x 20,5/8	5,3/4
305 44 42 626	17,5 x 52,5	20	6,7/8 x 20,5/8	7,7/8



Nature



Base legno per 3 ciotole in porcellana

Wood base fitting 3 porcelain bowls
Base en bois pour 3 bols en porcelaine
Base de madera para 3 boles de porcelana
Holzbasis für 3 Porzellan Bols

Noce - Walnut

	Cm	H Cm	In	H In
305 54 54 608	17,5 x 52,5	2,5	6,7/8 x 20,5/8	1



Ciotola Artesano

Artesano bowl
Bol Artesano
Bol Artesano
Artesano bol

Porcellana - Porcelain

	Lt	Oz
264 02 51 900	0,6	21



Base in legno con 3 fori

Wood base with 3 holes

Base en bois avec 3 trous

Base de madera con 3 agujeros

Holzbasis mit 3 runden Ausschnitten

Noce - Walnut

	Cm	H Cm	In	H In
305 54 54 609	17,5 x 52,5	2,5	6,7/8 x 20,5/8	1

**Vaso in vetro con coperchio**

Glass jar with lid

Pot en verre avec couvercle

Jarrón de vidrio con tapa

Glasdose mit Deckel

Vetro - Glass

	Ø Cm	H Cm	In	H In
404 10 31 304	14	17,5	5,1/2	6,7/8
404 10 31 305	14	23	5,1/2	9
404 10 31 306	14	29,5	5,1/2	11,5/8

**Coppetta affinity**

Affinity bowl

Bol Affinity

Bol Affinity

Affinity Bol

Porcellana - Porcelain

	Ø Cm	Ø In
264 00 43 800	15	6

**Coperchio per coppetta in vetro**

Lid for glass bowl

Couvercle pour bol en verre

Tapa para bol de vidrio

Deckel für Glasschale

Inox 18/10 - St. Steel

	Ø Cm	Ø In
B01 12 52 640	15	6

**Coppetta in vetro**

Glass bowl

Bol en verre

Bol de vidrio

Glasschale

Vetro - Glass

	Ø Cm	Ø In
V76 08 52 004	15	6







Nature

Piatto ovale Artesano

Artesano oval bowl
Coupe ovale Artesano
Plato oval Artesano
Artesano Schale oval

Porcellana - Porcelain

	Cm	In
264 02 53 844	55 x 17	21,5/8 x 6,3/4



Insalatiera Artesano

Artesano salad bowl
Saladier Artesano
Ensaladera Artesano
Artesano Schüssel rund

Porcellana - Porcelain

	Ø Cm	Ø In
264 02 53 170	28	11



Piatto presentazione Artesano

Artesano presentation bowl
Coupe présentation Artesano
Plato presentación Artesano
Artesano Präsentationsschale rund

Porcellana - Porcelain

	Ø Cm	Ø In
264 02 53 760	37	14,1/2





Alzata rettangolare per porcellane

Rectangular podium for porcelain items

Support rectangulaire pour articles en porcelaine

Soporte rectangular para artículos de porcelana

Podest rechteckig für Artikel aus Porzellan

Nero opaco - Matte black

	Cm	H Cm	In	H
305 44 42 624	12 x 40	13,5	4,3/4 x 15,3/4	5,3/4
305 44 42 632	12 x 40	20	4,3/4 x 15,3/4	7,7/8

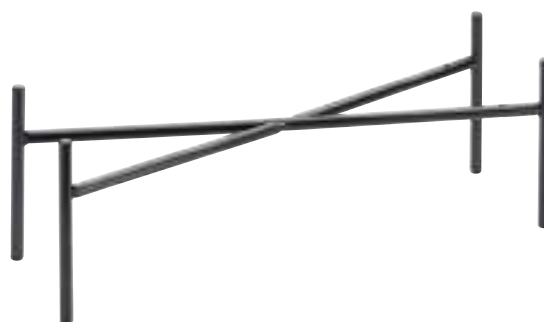

Alzata quadrata

Square podium

Support carré

Soporte cuadrado

Podest quadratisch

Nero opaco - Matte black

	Cm	H Cm	In	H In
305 44 42 621	18 x 18	20	7 x 7	7,7/8
305 44 42 622	18 x 18	25	7 x 7	9,7/8
305 44 42 623	18 x 18	30	7 x 7	11,3/4









Secchio champagne

Champagne bucket
 Seau à champagne
 Cubo champàn
 Champagnerkühler

Tiglio - Lime wood

	Ø Cm	Ø In
305 54 43 628	20	7,7/8



Coppa punch

Punch bucket
 Bol à punch
 Champañera
 Punch Bol mit Einsatz

Tiglio - Lime wood

	ØCm	Ø In
305 54 43 629	40	15,3/4



Tagliere con cinghia acciaio

Cutting board with st. steel belt
 Planche à découper
 Tabla de cortar con cinturón de acero
 Schneidbrett mit Edelstahlband

Noce - Walnut

	Ø Cm	Ø In
305 04 71 980	40	15,3/4



Piccolo tagliere pane c/vassoio in noce

Small bread cutting board with tray Walnut
 Petite planche à pain avec plateau Noyer
 Kleines Brotschneidebrett mit Tablett Nussbaum
 Tabla de cortar pan pequeña con bandeja Nogal

	Cm	In
Tagliere e vassoio - Cutting board with tray		
305 54 54 625	26 x 35	10,2 x 13,7

Tagliere - Cutting board		
305 54 54 626	26 x 35	10,2 x 13,7

Vassoio - Tray		
305 54 23 886	26 x 35	10,2 x 13,7



Tagliere pane in noce

Cutting board, walnut wood
 Planche à découper
 Brotschneidebrett Walnussholz
 Tabla de cortar

	Cm	In
Tagliere e vassoio - Cutting board with tray		
305 54 54 618	52.5 x 35	20,6 x 13,7

Tagliere - Cutting board		
305 54 54 617	52.5 x 35	20,6 x 13,7

Vassoio - Tray		
305 54 23 854	52.5 x 35	20,6 x 13,7



Vassoio refrigerato

Thermal tray
 Plateau réfrigéré
 Bandeja refrigerada
 Thermo-Platte

Noce - Walnut

	Cm	In
305 54 52 730	52,5 x 32,5	20,5/8 x 12,3/4



Nature

Piatto torta con cloche Nature Buffet

Cake plate with Nature Buffet dome cover

Plat à gâteau avec cloche Nature Buffet

Plato tarta con cúpula Nature Buffet

Tortenplatte mit Glocke Nature Buffet

	Ø Cm	Ø In
305 54 42 669	40	15,3/4



Alzata quadrata per piatto torta quadrato

Square podium for square cake plate

Support carré pour plat à gâteau carré

Soporte cuadrado para plato pastel cuadrado

Podest quadratisch

	Cm	H Cm	In	H In
305 44 42 667	26 x 26	20	10,2 x 10,2	7,7/8

● nero - black

Piatto torta con cloche non incluso / Cake plate not included





Cavalletto portaetichetta per buffet

Buffet easel for tags

Chevalet porte-nom pour buffet

Soporte caballete para etiqueta para buffet

Aufsteller Produktinfo

Acciaio inox 18/10 - St. Steel

	Cm	H Cm	In	H In
V01 05 19 001	7 x 7	15	2,3/4 x 2,3/4	6

Tavoletta nera per cavalletto

Black tag for easel

Plaque noire pour chevalet

Etiqueta negra para soporte caballete

Schild für Produktinfo

Plexiglass

	Cm	In
V01 12 19 001	10 x 7,5	4 x 3



Nature

Rinfrescacaraffe 4 comparti

Thermal pitcher, 4-pc set
Rafraîchisseur à 4 carafes
Enfriador para 4 jarras
Thermo-Karaffeather 4 Stck.

Noce - Walnut

	Cm	H Cm	In	H In
305 54 24 586	28 x 28	9	11 x 11	3,1/2



Caraffa vetro con coperchio basculante

Glass pitcher Lt 1,5 with rolltop lid
Carafe à eau avec couvercle basculante
Jarra vidrio con tapa giratoria
Wasserkaraffe

ACQUA NATURALE/STILL WATER

	Cm	H Cm	Lt	Oz
305 05 08 548	29	11,4	1	35

ACQUA FRIZZANTE/SPARKLING WATER

	Cm	H Cm	Lt	Oz
305 05 08 549	29	11,4	1	35



Coppa macedonia

Thermal fruit salad bowl
Rafraîchisseur salade de fruits
Bol macedonia de frutas refrigerado
Thermo-Fruchtsalatschalel

Noce - Walnut

	Cm	In
305 54 52 641	28 x 28	11 x 11



Set 2 coppe yogurt

Thermal yogurt set, 2-bowl
Set 2 bols yaourt réfrigérés
Set 2 boles yogur refrigerados
Thermo-Schalen 2 Stck.

Noce - Walnut

	Cm	In
305 54 52 640	21,5 x 38,5	8,1/2 x 15,1/8



Rinfrescacaraffe 2 comparti

Double thermal pitcher
Rafraîchisseur à 2 carafes
Enfriador para 2 jarras
Thermo-Karaffenthaler 2 Stck.

Noce - Walnut

	Cm	In
305 54 52 634	21,5 x 38,5	8,1/2 x 15,1/8

**Rinfrescacaraffe 1 comparto**

Thermal pitcher, individual
Rafraîchisseur à carafes individuel
Enfriador de jarras individual
Thermo-Karaffenthaler 1 Stck.

Noce - Walnut

	Cm	In
305 54 52 731	21,5 x 21,5	8,1/2 x 8,1/2

**Caraffa succhi con coperchio**

Juice pitcher with lid
Carafe à jus avec couvercle
Jarra zumo con tapa
Saftkrug mit Deckel

	Lt	Oz
305 05 08 539	1,5	53



Nature

Distributore succhi

Thermal juice dispenser
Distributeur de jus réfrigéré
Dispensador de zumo refrigerado
Thermo-Saftspender

Noce - Walnut

	Lt	Oz	Cm	H Cm	In	H In
305 54 52 644	3,5	122,5	23 x 32	48	9 x 12,5/8	19
305 54 52 633	7	245	28 x 35,5	53	11 x 14	20,7/8



Distributore caffè

Coffee urn
Distributeur de café
Dispensador de café
Kaffeespender

Noce - Walnut

	Lt	Oz	Cm	H Cm	In	H In
305 54 52 631	7	245	28 x 35,5	54	11 x 14	21,1/4
305 54 52 632	10	350	28 x 35,5	62	11 x 14	24,3/8



Distributore cereali

Cereal dispenser
Distributeur céréales
Dispensador cereales
Cerealienspender 1-fach

Noce - Walnut

	Lt	Oz	Cm	H Cm	In	H In
305 54 52 636	4	122,5	23 x 32	56	9 x 12,5	22



Vassoio formaggi refrigerato

Thermal cheese/cold cuts tray
 Plateau à fromage/charcuterie réfrigéré
 Bandeja quesos/embutidos refrigerada
 Thermo-Aufschnittplatte

Noce - Walnut

	Cm	H cm	In	H In
305 54 54 577	52 x 32,5	21,5	20,5/8 x 12,3/4	8,1/2



Vassoio refrigerato

Thermal tray, ice packs on demand
 Plateau réfrigéré, blocs réfrigérants sur demande
 Bandeja refrigerada, acumuladores de frío disponibles
 Thermo-Platte, Kühlelemente auf Anfrage

Noce - Walnut

	Cm	H cm	In	H In
305 54 52 699	52.5 x 32.5	4	20,5/8 x 12,3/4	1,5/8



EUTETTICI INCLUSI

ICE PACKS INCLUDED

BLOCS RÉFRIGÉRANTS INCLUS

ACUMULADORE DE FRÍO INCLUIDOS

KÜHLAKKUS INKLUSIVE

Vassoio yogurt refrigerato con ghiaccio

Ice thermal yogurt tray
 Plateau à yaourts réfrigéré à glace
 Bandeja yogures refrigerable con hielo
 Joghurtablett, mit Eis kühlbar

Noce - Walnut

	Cm	H cm	In	H In
305 54 52 638	52.5 x 32.5	4	20,5/8 x 12,3/4	1,5/8



Supporto in legno con piastra a induzione

Wooden stand Life + Induction plate
 Support bois + Plaque à induction
 Soporte madera + Placa de inducción
 Holzständer + Induktionsplatte

	Cm	H cm	In	H In
V33 04 52 001	32 x 38	8	12,5/8 x 15	3,1/8



Jambee

Jambee distributore marmellata/miele con base in legno

Jambee jam/honey dispenser with wood base

Distributeur confiture/miel Jambee avec base en bois

Jambee distribuidor de mermelada/miel con base de madera

Jambee Konfitür/honigspender mit Holzbasis

Noce - Walnut

	Lt	Oz	Cm	In
305 05 52 721	0,7	23	12,5 x 34,5 H Min 40,5 H Ma x 54	5 x 13,5/8 H Min 16 H Ma x 21,1/4
305 05 52 722	1	33,8	12,5 x 34,5 H Min 48 H Ma x 70	5 x 13,5/8 H Min 18,7/8 H Ma x 27,1/2



Jambee

Jambee

Jambee

Jambee

Jambee

Acciaio Inox 18/10 - St. Steel

	Lt	Oz	Cm	In
V77 0552 DMB	0,7	23	12,5 x 34,5 H Min 39 H Ma x 54	5 x 13,5/8 H Min 15,3/8 H Ma x 21,1/4
V77 0552 DMC	1	33,8	12,5 x 34,5 H Min 47 H Ma x 69	5 x 13,5/8 H Min 18,1/2 H Ma x 27,1/8



Erogatore a siringa

Syringe nozzle
 Embout seringue
 Ausgieberspritze
 Boquilla jeringa

Inox 18/10 - St. Steel

Z77 4652 DMA



Pistone con coperchio

Piston with lid
 Piston avec couvercle
 Kolben mit Deckel
 Pistón con tapa

Inox 18/10, Metacrilato e PP - St. Steel, Methacrylate and PP

	Lt
Z77 9852 DMA	0,7
Z77 9852 DMA1	1



Contentitore

Container
 Conteneur
 Behälter
 Contenedor

Metacrilato - Methacrylate

	Lt
Z77 2052 DMA	0,7
Z77 2052 DMA1	1

Tappo

Cap
 Capsule
 Stöpsel
 Tapón

Metacrilato - Methacrylate

Z77 1352 DMA

Targhetta porta etichetta

Label plate
 Plaque porte-étiquette
 Schild Etikettenhalter
 Placa porta etiqueta

Metacrilato - Methacrylate

Z77 5752 DMA1





Zeta Buffet



Distributore caffè

Coffee urn
Distributeur de café
Dispensador de café
Kaffeespender

	Lt	Cm	H Cm
305 05 52 631 <input checked="" type="checkbox"/>	7	25 x 35	54
305 45 52 631 <input type="checkbox"/>			
305 05 52 632 <input checked="" type="checkbox"/>	10	25 x 35	62
305 45 52 632 <input type="checkbox"/>			



Distributore succhi refrigerato

Thermal juice dispenser
Distributeur de jus réfrigéré
Dispensador de zumo refrigerado
Thermo-Saftspender

	Lt	Cm	H Cm
305 05 52 633 <input checked="" type="checkbox"/>	7	25 x 35	53
305 45 52 633 <input type="checkbox"/>			
305 05 52 644 <input checked="" type="checkbox"/>	3,5	18 x 30	48
305 45 52 644 <input type="checkbox"/>			



Distributore cereali

Cereal dispenser
 Distributeur céréales
 Dispensador cereales
 Cerealispender 1-fach

	Kg	Cm	H Cm
305 05 52 636 <input checked="" type="checkbox"/>	1,5	15 x 24	58
305 45 52 636 <input type="checkbox"/>			

**Distributore cereali 2 comparti**

Double cereal dispenser
 Distributeur céréales double
 Dispensador cereales doble
 Cerealispender 2-Fach

	Kg	Cm	H Cm
305 05 52 635 <input checked="" type="checkbox"/>	2 x 1,5	25 x 32	58
305 45 52 635 <input type="checkbox"/>			



Zeta White



Rinfrescacaraffe 2 comparti

Double thermal pitcher
 Rafrâchisseur à 2 carafes
 Enfriador para 2 jarras
 Thermo-Karaffenhalter 2 Stck.

	Cm	H Cm	Lt
305 05 52 634 ■	42 x 24	22	1,5
305 45 52 634 □			



Caraffa succhi con coperchio

Juice pitcher with lid
 Carafe à jus avec couvercle
 Jarra zumo con tapa
 Saftkrug mit Deckel

	Lt	Oz
305 05 08 539	1,5	53



Rinfrescacaraffe 4 comparti acciaio inox

Thermal pitcher 4-pc set
 Rafrâchisseur à 4 carafes
 Enfriador para 4 jarras
 Thermo-Karaffehalter 4 Stck.

	Cm	In	H Cm	H In
305 05 24 586 ■	30 x 30	11,8 x 11,8	8,5	3,3
305 45 24 586 □				

* caraffe incluse / included pitcher



Caraffa vetro con coperchio basculante

Glass pitcher Lt 1,5 with rolltop lid
 Carafe à eau avec couvercle basculante
 Jarra vidrio con tapa giratoria
 Wasserkaraffe

ACQUA NATURALE/STILL WATER

	Cm	H Cm	Lt	Oz
305 05 08 548	29	11,4	1	35

ACQUA FRIZZANTE/SPARKLING WATER

	Cm	H Cm	Lt	Oz
305 05 08 549	29	11,4	1	35



Rinfrescabottiglie termico 3 posti

3-bottle cooler

Rafrachisseur à 3 bouteilles

Enfriador para 3 botellas

Flaschenkühler 3-Fach

	Cm	H Cm
305 05 52 646 ■	42 x 24	23,5
305 45 52 646 □	42 x 24	23,5



Set 2 coppe yogurt refrigerate

Thermal yogurt set, 2-bowl

Set 2 bols yaourt réfrigérés

Set 2 boles yogur refrigerados

Thermo-Schalen 2 Stck.

	Cm	H Cm	Ø Cm	Lt
305 05 52 640 ■	42 x 24	13,5	15	0,5
305 45 52 640 □	42 x 24	13,5	15	0,5



Set 2 coppe macedonia refrigerate

Thermal fruit-salad set, 2-bowl

Set 2 bols salade de fruits réfrigérés

Set 2 boles macedonia de frutas refrigerados

Thermo-Fruchtsalatschale 2 Stck. schwarz

	Cm	H Cm	Ø Cm	Lt
305 05 52 637 ■	55 x 34,5	16	23	1,8
305 45 52 637 □	55 x 34,5	16	23	1,8



Coppa macedonia refrigerata

Thermal fruit salad bowl

Rafrachisseur salade de fruits

Bol macedonia de frutas refrigerado

Thermo-Fruchtsalatschale

	Cm	H Cm	Ø Cm	Lt
305 05 52 641 ■	30 x 30	16	23	1,8
305 45 52 641 □	30 x 30	16	23	1,8





Supporto alto per 3 coppette

3-bowl podium, tall
Support haut à 3 coupelles
Soporte alto para 3 boles
Buffetständer 3 Bowlst

	Cm	H Cm	Ø Cm	Lt
305 05 54 580 ■	42,5 x 15	19	12	0,25
305 45 54 580 □	42,5 x 15	19	12	0,25

Supporto basso per 3 coppette

Podium 3-bowl, short
Support bas à 3 coupelles
Soporte bajo para 3 boles
Buffetständer 3 Bowlst

	Cm	H Cm	Ø Cm	Lt
305 05 54 579 ■	42,5 x 15	11,5	12	0,25
305 45 54 579 □	42,5 x 15	11,5	12	0,25

Coperchio in metacrilato con pom. per coppa

Bowl cover
Couvercle metachrilè pour coupe en verre
Tapa acrílica con pom. para boles
Acryldeckel m. Griff f. Glassch.

	Ø Cm
305 12 15 798	12



Supporto alto per 2 coppe cereali con coperchio

2-bowl podium with lids, tall
Support haut à 2 coupes avec couvercles
Soporte alto para 2 boles con tapas
Buffetständer 2 Bowlst mit Deckel

	Cm	H Cm	Ø Cm	Lt
305 05 54 607 ■	62 x 28	30	23	1,8
305 45 54 607 □	62 x 28	30	23	1,8

Supporto basso per 2 coppe cereali con coperchio

2 bowl podium with lids, short
Support bas à 2 coupes avec couvercles
Soporte bajo para 2 boles con tapas
Buffetständer 2 Bowlst mit Deckel

	Cm	H Cm	Lt
305 05 54 606 ■	55 x 28	10	1,8
305 45 54 606 □	55 x 28	10	1,8





Vassoio formaggi ed affettati refrigerato

Thermal cheese/cold cuts tray

Plateau à fromage/charcuterie réfrigéré

Bandeja quesos/embutidos refrigerada

Thermo-Aufschnittplatte

	Cm	H Cm
305 05 54 577 <input checked="" type="checkbox"/>	55 x 34,5	20
305 45 54 577 <input type="checkbox"/>		



Vassoio refrigerato, eutettici a richiesta

Thermal tray, ice packs on demand

Plateau réfrigéré, blocs réfrigérants sur demande

Bandeja refrigerada, acumuladores de frío disponibles

Thermo-Platte, Kühlelemente auf Anfrage

	Cm	H Cm
305 05 52 699 <input checked="" type="checkbox"/>	55 x 34,5	4
305 45 52 699 <input type="checkbox"/>		



Vassoio yogurt Zeta refrigerato con ghiaccio

Zeta ice thermal yogurt tray

Plateau à yaourts réfrigéré à glace Zeta

Bandeja yogures refrigerable con hielo Zeta

Joghurttablett Zeta, mit Eis kühlbar

	Cm	H Cm
305 05 52 638 <input checked="" type="checkbox"/>	55 x 34,5	4
305 45 52 638 <input type="checkbox"/>		



Cestino pane acciaio inox

Bread basket with roll-top cover
 Corbeille à pain avec couvercle roll-top
 Cesta pan con tapa roll-top
 Brotkorb mit Rolltop

	Cm	H Cm
305 05 52 650 <input checked="" type="checkbox"/>	55 x 34,5	25
305 45 52 650 <input type="checkbox"/>		

**Cestino portapane con cloche**

Bread basket with roll-top cover
 Corbeille à pain avec couvercle roll-top
 Cesta pan con tapa roll-top
 Rattan Brotkorb mit Rolltop

	Cm	H Cm
305 05 52 642 <input checked="" type="checkbox"/>	55 x 34,5	30
305 45 52 642 <input type="checkbox"/>		

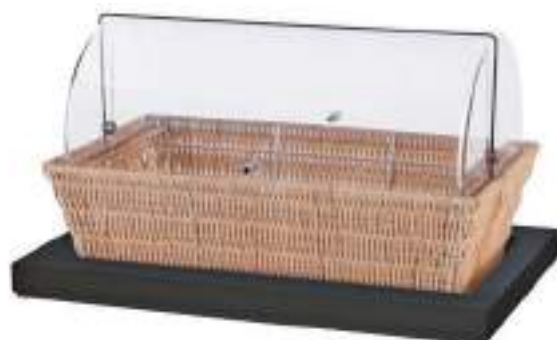
**Tagliere pane con base**

Bread cutting board with base
 Planche à pain avec plateau
 Tabla de cortar con base
 Brotschneidebrett

	Cm	H Cm
305 05 54 578 <input checked="" type="checkbox"/>	55 x 34,5	6
305 45 54 578 <input type="checkbox"/>		



Scaldabrioche

Croissant warmer
Chauffe-croissants
Calienta croissants
Croissantwärmer



Cm	H Cm
55 x 34,5	24,3

305 05 52 651
 305 45 52 651



Alzata filo per basi GN 1/1

Wire stand for GN 1/1
Support en fil pour GN 1/1
Soporte en hilo para GN 1/1
Buffetständer mit GN 1/1 Einsatz

Cm	H Cm
57,5 x 35,8	27,6

305 05 42 597



Supporto con schermo igienico GN 1/1

Stand with hygienic shield
Ecran hygiénique
Pantalla higiénica
Buffetständer mit Hygieneplatte

Cm
59 x 34,4

305 12 53 609



Alzata torta con cloche

Cake stand with roll-top cover
Présentoir à gâteau x avec couvercle roll-/top
Presentación tarta con tapa roll-top
Tortenplatte mit Rolltop

	Ø Cm	Base Cm	H Cm
305 05 42 600 ■	38	18 x 18	37,2
305 45 42 600 □			

**Coppa punch**

Punch bowl
Bol à punch
Champañera
Punch Bowl

	Ø Cm	Base Cm	H Cm
305 05 43 613 ■	40	18 x 18	33
305 45 43 613 □			

**Vassoio multifunzione rettangolare**

Ectangular multipurpose tray
Plateau multi-usage rectangulaire
Bandeja multiuso rectangular
Multifunktionstablett rechteckig

	Cm	H Cm
305 05 52 652 ■	55 x 34,5	4
305 45 52 652 □		

**Vassoio multifunzione quadrato**

Square multipurpose tray
Plateau multi-usage carré
Bandeja multiuso cuadrada
Multifunktionstablett viereckig

	Cm	H Cm
305 05 52 654 ■	30 x 30	4
305 45 52 654 □		





Scaldavivande Chafing dish

Acciaio - St. Steel



Scaldavivande

Scaldavivande rettangolare 2/3

Chafing dish rectangular 2/3

Chafing dish rectangulaire 2/3

Chafing dish rectangular 2/3

Chafing Dish rechteckig 2/3

Acciaio Inox 18/10 - St. Steel 18/10

	GN	Cm	H Cm	In	H In
335 05 52 002	1/1	37x40	13,5	14,1/2x15,3/4	5 3/8



Scaldavivande rettangolare 1/1

Chafing dish rectangular 1/1

Chafing dish rectangulaire 1/1

Chafing dish rectangular 1/1

Chafing Dish rechteckig 1/1

Acciaio Inox 18/10 - St. Steel 18/10

	GN	Cm	H Cm	In	H In
335 05 52 001	1/1	57,5x37	13,5	22,5/8x14,1/2	5 3/8





Supporto scaldavivande rettangolare 2/3

Chafing dish stand rectangular 2/3

Support chafing dish rectangulaire 2/3

Soporte chafing dish rectangular 2/3

Chafing Dish Ständer rechteckig 2/3

Acciaio Inox - St. Steel

	Cm	H Cm	In	H In
B25 05 52 002	37,5x40,5	20,5	14,3/4 x16	8



Supporto scaldavivande rettangolare 1/1

Chafing dish rectangular 1/1

Chafing dish rectangulaire 1/1

Chafing dish rectangular 1/1

Chafing Dish rechteckig 1/1

Acciaio Inox - St. Steel

	Cm	H Cm	In	H In
B25 05 52 001	58x37,5	20,5	22,7/8x14,3/4	8

Piastra induzione 1000 W - 220 V - 50/60 Hz
Induction plate 1000 W - 220 V - 50/60 Hz

335 05 52 005



Fornelletto per scalavivande
Chafing dish burner



Scaldavivande

Scaldavivande tondo

Chafing dish round
Chafing dish rond
Chafing dish redondo
Chafing Dish rund

Acciaio Inox 18/10 - St. Steel 18/10

	Ø Cm	H Cm	Ø In	H In
335 05 52 003	44	13,5	17,3/8	5,3/8



Zuppiera

Soup tureen
Soupière
Sopera
Suppenterrine

Acciaio Inox 18/10 - St. Steel 18/10

	Ø Cm	H Cm	Ø In	H In
335 05 52 004	37,5	24,5	1,3/4	9,5/8





Supporto scaldavivande tondo ø40 cm

Chafing dish stand round
 Support chafing dish rond
 Soporte chafing dish redondo
 Chafing Dish Ständer rund

Acciaio Inox - St. Steel

	Ø Cm	H Cm	Ø In	H In
B25 05 52 003	44,5	20,5	17,1/2	8



Supporto zuppiera

Essenza soup tureen stand
 Support de soupière
 Soporte sopera
 Suppenterrinenständer

Acciaio Inox - St. Steel

	Ø Cm	H Cm	Ø In	H In
B25 05 52 004	38	20,5	15	8

Piastra induzione 1000 W - 220 V - 50/60 Hz
Induction plate 1000 W - 220 V - 50/60 Hz

335 05 52 005



Fornelletto per scalavivande
Chafing dish burner



Scaldavivande

Sistema impilabile

Perfectly stackable system



Coperchio facilmente removibile

Easily removable lid

Inserto GN 1/1 in acciaio inox

Food pan, GN 1/1 18/10, stainless steel

V01 05 72 G11B

H 6,5 Cm



Inserto GN 2/3 in acciaio inox

Food pan, GN 2/3 18/10, stainless steel

V01 05 72 G23B

H 6,5 Cm



Inserto GN 1/3 in acciaio inox

Food pan, GN 1/3 18/10, stainless steel

V01 05 72 G13B

H 6,5 Cm



Inserto GN 1/2 in acciaio inox

Food pan, GN 1/2 18/10, stainless steel

V01 05 72 G12B

H 6,5 Cm



Inserto GN 1/1 in porcellana

Food pan, GN 1/1, porcelain

305 21 52 557

H 6,5 Cm



Inserto GN 2/3 in porcellana

Food pan, GN 2/3, porcelain

305 21 52 583

H 6,5 Cm



Inserto GN 1/2 in porcellana

Food pan, GN 1/2, porcelain

305 21 52 581

H 6,5 Cm



Inserto GN 1/3 in porcellana

Food pan, GN 1/3, porcelain

305 21 52 582

H 6,5 Cm





Manhattan Buffet



Manhattan

SET 1

Manhattan Tower
Tower Manhattan
Tower Manhattan
Manhattan Tower

305 05 52 A01 Cm 140 x 42

H Cm
65



SET 2

Manhattan Tower
Tower Manhattan
Tower Manhattan
Manhattan Tower

305 05 52 A02 Cm 140 x 42

H Cm
50



SET 4

Manhattan Tower
Tower Manhattan
Tower Manhattan
Manhattan Tower

305 05 52 A04 Cm 260 x 42

H Cm
65



SET 3

Manhattan Tower
 Tower Manhattan
 Tower Manhattan
 Manhattan Tower

305 05 52 A03 Cm 150 x 145

H Cm
 65



Tower

Tower
 Tower
 Tower
 Tower

305 05 42 604 Cm 20 x 20
 305 05 42 605 20 x 20
 305 05 42 606 20 x 20
 305 05 42 607 20 x 20

H Cm
 10
 22
 34
 58



Modulo a croce

Cross-shaped e x tension unit
 Croi x
 Módulo con forma de cruz
 Verbindungskreuz

305 05 42 608 H Cm 9,5

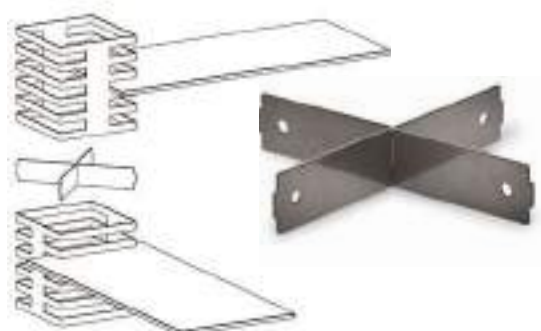

Manhattan

Piano in vetro fumé

Smoky glass top

Dessus en verre fumé

Tablero de cristal fumé

Glasplatte Smoky

	Cm
V87 08 42 Q01	30 x 30
V87 08 42 Q02	42 x 42
V87 08 42 R01	30 x 70
V87 08 42 R02	30 x 100
V87 08 42 R03	42 x 70
V87 08 42 R04	42 x 100



Piano in ardesia

Slate top

Dessus en ardoise

Tablero de pizarra

Schieferplatte

	Cm
V87 09 42 Q01	30 x 30
V87 09 42 Q02	42 x 42
V87 09 42 R01	30 x 70
V87 09 42 R02	30 x 100
V87 09 42 R03	42 x 70
V87 09 42 R04	42 x 100



Piano in mdf

Mdf top

Dessus en mdf

Tablero de mdf

Mdf Platte

	Cm
V87 04 42 Q01	30 x 30
V87 04 42 Q02	42 x 42
V87 04 42 R01	30 x 70
V87 04 42 R02	30 x 100
V87 04 42 R03	42 x 70
V87 04 42 R04	42 x 100



Totem

Totem

Totem

Totem

Totem

	Cm	H Cm
305 05 42 609	24 x 24	14
305 05 42 610	24 x 24	22
305 05 42 611	32,5 x 32,5	14
305 05 42 612	32,5 x 32,5	22





Caratteristiche tecniche

- A** Asportabilità del coperchio a 90° con estrema facilità.
- B** Coperchio leggero e facilmente maneggiabile.
- C** Blocco automatico dell'estrazione del coperchio in fase di lavoro (da 0° a 89°).
- D** Chiusura e apertura frenata del coperchio. Sistema di cerniere brevettate Abert
- E** Superati i 70° il coperchio si apre completamente lasciandolo andare.
- F** La cerniera è un meccanismo a molla, inalterabile nel tempo, non necessita di regolazione e di manutenzione in quanto non ha frizione.
- G** Tutti i meccanismi sono costruiti in pregiati materiali inossidabili, quindi resistenti alla corrosione, agli ambienti umidi e adatti al contatto con gli alimenti.
- H** Lo scaldavivande è progettato per raccogliere la condensa in modo da lasciare il piano di appoggio completamente asciutto.
- I** Può essere utilizzato sia con riscaldamento elettrico sia con fornelli a combustibile solido.

Technical characteristics

- A** Easily removable cover, at 90°.
- B** Light and easy-to-handle cover.
- C** Automatic block of cover pull out when in operation (from 0° to 89°).
- D** Closing and opening slowed by cover. Abert patented system.
- E** Over 70° the cover opens fully when released.
- F** The hinge is a spring mechanism, inalterable in time, it does not need regulation and maintenance as it has no clutch.
- G** All the machineries are built in refined stainless materials, thus resistant to corrosion, humid environment and suitable for food contact.
- H** The chafing dish is designed to collect condensation, In order to keep the support base completely dry.
- I** Both electric warming and solid-fuelburners can be used.



Piastra elettrica Gn 2/3

Electric plate for Ø Cm 30-40 round chafing dish
 Élément électrique pour chafing-dish rond Ø Cm 30-40
 Elemento eléctrica para chafing dish redondo Ø Cm 30-40
 Elektroelement für runden Chafing Dish Ø Cm 30-40

305 05 52 546

305 05 52 611 con regolatore - with regulator



Piastra elettrica Gn 1/1

Electric hot plate
 Plaque électrique
 Placa eléctrica
 Elektrische Platte

305 05 52 547

V77 05 52 PCR2 con regolatore - with regulator



Fornelletto per scaldavivande

Chafing-dish burner
 Porte brûleur pour chafing dish
 Contenedor de combustible para chafing dish
 Brennstoffhalter für Chafing Dish

305 05 52 536



Combustibile per scaldavivande

Solid fuel for chafing dish burner
 Combustible pour chafing dish
 Combustible para chafing dish
 Brennstoff für Chafing Dish

305 05 72 519



Scaldavivande con gambe e coperchio in acciaio inox

Chafing dish with St. Steel stand and cover
Chafing dish avec support et couvercle en acier inox
Chafing dish con soporte y tapa en acero inox
Chafing Dish mit Beinen und Edelstahldeckel

	Cm	H Cm
GN 1/1		
305 05 52 670	63 x 42	31
GN 2/3		
305 05 52 675	46 x 42	32

Completo di due fornelli a combustibile solido e predisposto per piastra elettrica.
 Portavivande GN 1/1 in acciaio incluso

With 1/1 Gastronorm food pan and two solid fuel burners.
Electric heating element available.



Scaldavivande con gambe e coperchio vetro

Chafing dish with glass stand and cover
Chafing dish avec support et couvercle en verre
Chafing dish con soporte y tapa en vidrio
Chafing Dish mit Beinen und Glass deckel

	Cm	H Cm
GN 1/1		
305 05 52 679	63 x 43	33
GN 2/3		
305 05 52 683	46 x 42	32

Completo di due fornelli a combustibile solido e predisposto per piastra elettrica.
 Portavivande GN 1/1 in acciaio incluso

With 1/1 Gastronorm food pan and two solid fuel burners.
Electric heating element available.



Scaldavivande da incasso con coperchio in acciaio inox / vetro

Built-in chafing dish with St. Steel / glass cover
Chafing dish encastrable avec couvercle en acier inox / verre
Chafing dish para empotrar con tapa en acero inox / vidrio
Chafing Dish zum Einbauen mit Edelstahl / Glass Deckel

	Cm	H Cm
GN 1/1		
305 05 52 692	60,5 x 40	39,5
GN 2/3		
305 05 52 694	43 x 40	21

Refrigerato / Thermal

GN 1/1		
305 05 52 705	60,5 x 40	39,5

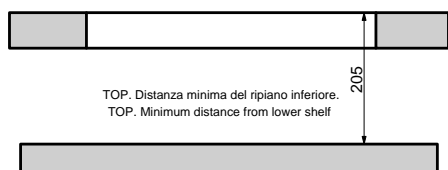
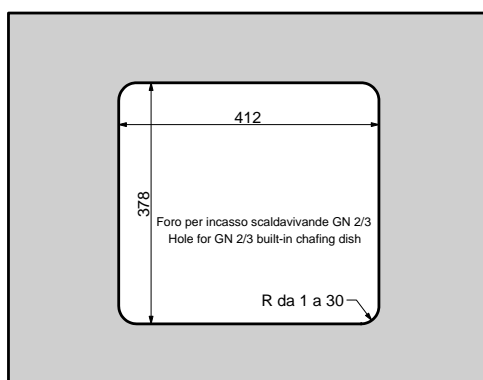

Scaldavivande da incasso con coperchio in acciaio inox

Built-in chafing dish with St. Steel cover
Chafing dish encastrable avec couvercle en acier inox
Chafing dish para empotrar con tapa en acero inox
Chafing Dish zum Einbauen mit Edelstahl Deckel

	Cm	H Cm
GN 1/1		
305 05 52 693	60,5 x 40,5	39,5
GN 2/3		
305 05 52 695	43 x 40	21

Refrigerato / Thermal

GN 1/1		
305 05 52 706	60,5 x 40,5	39,5

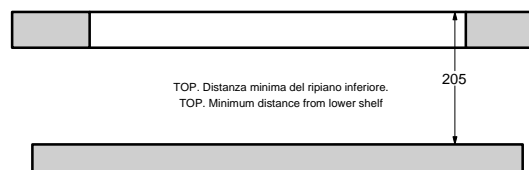
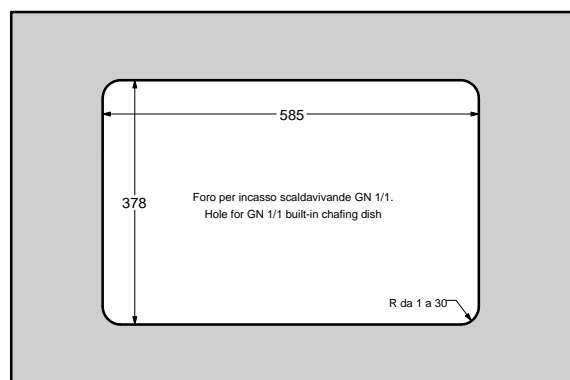



Scaldavivande a incastro GN 1/1

GN 1/1 built-in chafing dish
 Chafing dish encastrable GN 1/1
 Chafing dish empotrable GN 1/1
 Eingebautes Chafing Dish GN 1/1

305 05 52 665

Con coperchio in acciaio inox
 With Stainless steel cover

305 05 52 678

Con coperchio in vetro
 With glass cover

Completo di due fornelli a combustibile solido
 e predisposto per piastra elettrica.
 Portavivande GN 1/1 in acciaio incluso
 Supporti Manhattan esclusi

*With 1/1 Gastronorm food pan and two solid fuel burners.
 Electric heating element available.
 Manhattan stand excluded*



Set refrigerato a incastro GN 1/1

GN 1/1 built-in thermal set
 Set réfrigéré encastrable GN 1/1
 Set refrigerado empotrable GN 1/1
 Eingebautes Thermo-Einsatz GN 1/1

305 05 52 698

Con coperchio in vetro
 With glass cover

Set refrigerato GN 1/1 H.7,2 Cm completo di bacinella in acciaio inox ,
 griglia in acciaio inox , eutettici, vassoio GN 1/1 H.Cm 2 in acciaio inox .
 Supporti Manhattan esclusi

*Thermal set GN 1/1 H. 7,2 Cm with St. Steel pan, St. Steel grid, ice packs,
 St. Steel tray GN 1/1 H. Cm 2.
 Manhattan stand excluded*

Set refrigerato Manhattan affettati e formaggi

Manhattan thermal set, cold cuts/cheese
 Set réfrigéré Manhattan charcuterie(fromages)
 Set refrigerado Manhattan embutidos y quesos
 Gekühltes Set Manhattan für Aufschnitt und Käse

	Cm	h
305 05 52 767	62 x 42	22

GN 1/1 PORCELLANA H 2 Cm
 GN 1/1 PORCELAIN H 2 Cm



Set refrigerato Manhattan per frutta

Manhattan thermal set for fruit
 Set réfrigéré Manhattan pour fruits
 Set refrigerado Manhattan para frutas
 Gekühltes Set Manhattan für Obst

	Cm	h
305 05 52 766	62 x 42	22

3 x GN 1/3 PORCELLANA H 6,5 Cm
 3 x GN 1/3 PORCELAIN H 6,5 Cm



Set refrigerato Manhattan da appoggio

Manhattan thermal set (cold), self-standing
 Set réfrigéré Manhattan à poser
 Set refrigerado Manhattan sobre encimera
 Manhattan Thermoset (kalt), selbststehend

	Cm	h
305 05 52 764	62 x 42	22

GN 1/1 ACCIAIO H 6,5 Cm
 GN 1/1 STAINLESS STEEL H 6,5 Cm



Set riscaldato Manhattan da appoggio

Manhattan thermal set (hot), self-standing
 Set chauffant Manhattan à poser
 Set calentador Manhattan sobre encimera
 Manhattan Thermoset (heiß), selbststehend

	Cm	h
305 05 52 765	62 x 42	22

GN 1/1 ACCIAIO H 6,5 Cm
 GN 1/1 STAINLESS STEEL H 6,5 Cm



Inserto GN 1/1 in acciaio inox

Food pan, GN 1/1 18/10, stainless steel

V01 05 72 G11B

H. 6,5 Cm



Vassoio GN 1/1 in acciaio inox

Tray, Gn 1/1, stainless steel

V01 05 72 G11

H. 2 Cm



Inserto GN 2/3 in acciaio inox

Food pan, GN 2/3 18/10, stainless steel

V01 05 72 G23B

H. 6,5 Cm



Inserto GN 1/3 in acciaio inox

Food pan, GN 1/3 18/10, stainless steel

V01 05 72 G13B

H. 6,5 Cm



Inserto GN 1/2 in acciaio inox

Food pan, GN 1/2 18/10, stainless steel

V01 05 72 G12B

H. 6,5 Cm



Inserto GN 1/1 in porcellana

Food pan, GN 1/1, porcelain

305 21 52 557

H. 6,5 Cm



Inserto GN 1/1 in porcellana

Food pan, GN 1/1, porcelain

3052152672

H. 2 Cm



Inserto GN 2/3 in porcellana

Food pan, GN 2/3, porcelain

305 21 52 583

H. 6,5 Cm



Inserto GN 1/2 in porcellana

Food pan, GN 1/2, porcelain

305 21 52 581

H. 6,5 Cm



Inserto GN 1/3 in porcellana

Food pan, GN 1/3, porcelain

305 21 52 582

H. 6,5 Cm



Piatto piano quadrato in porcellana

Square flat plate, porcelain

263 33 42 649

22 x 22 Cm



Piatto fondo quadrato in porcellana

Square deep plate, porcelain

263 33 42 130

22 x 22 Cm





Classica Buffet



Classica

Distributore caffè linea classica

Classica coffee urn
Distributeur de café Classica
Dispensador de café Classica
Kaffeedispenser Classica

	Lt	Oz	Cm	H Cm
303 ... 52 549	7	245	32 x 25	53
303 ... 52 550	10	350	24 x 32	52



Distributore succhi linea classica

Classica juice dispenser
Distributeur de jus Classica
Dispensador de zumo Classica
Saftspender Classica

	Lt	Oz	Cm	H Cm
303 ... 52 603	8	280	25 x 36	72



**Piastra elettrica
per distributore caffè**

**Electric heating
element for coffee urn**



**Piastra elettrica rettangolare
per scaldavivande gn 1/1**

**Electric heating element
for GN1/1 rectangular chafing dish**



COD. 303 07..... acciaio argentato - electro-plated stainless steel (EPSS)
 COD. 303 03..... acciaio argentato e ottone - electro-plated stainless steel (EPSS) and brass
 COD. 303 05..... acciaio e ottone - stainless steel and brass
 COD. 303 55..... acciaio inossidabile - stainless steel

Scaldavivande tondo linea Classica

Classica round chafing dish
 Chafing dish rond Classica
 Chafing dish redondo Classica
 Chanfing Dish Classica, rund

	Ø Cm	Ø In
303 .. 52 614	40	15,3/4

Con cloche rotante (180°) a scomparsa, fornito di portavivande Gastronorm e due bruciatori a combustibile solido. Predisposto per piastra elettrica.

*With revolving foldaway dome opening at 180°, Gastronorm food pan and two solid fuel burners.
 Electric heating element available.*



Scaldavivande rettangolare linea Classica

Classica rectangular chafing dish
 Chafing dish rectangulaire Classica
 Chafing dish rectangular Classica
 Chafing Disch Classica , rechteckig

	GN	In	Cm	H Cm
303 .. 52 612	1/1	1/1	67 x 43	45

Con cloche rotante (180°) a scomparsa, fornito di portavivande 1/1 Gastronorm e due bruciatori a combustibile solido. Predisposto per piastra elettrica.

*With revolving foldaway dome opening at 180°, 1/1 Gastronorm food pan and two solid fuel burners.
 Electric heating element available.*



Piastra elettrica per scaldavivande tondo Ø Cm 30-40

Electric heating element for Ø Cm 30-40 chafing dish



Fornelletto per scaldavivande

Chafing dish burner



ChafingDishAccessories

Inserto GN 1/1 in acciaio inox

Food pan, GN 1/1 18/10, stainless steel

V01 05 72 G11B

H. 6,5 Cm



Vassoio GN 1/1 in acciaio inox

Tray, Gn 1/1, stainless steel

V01 05 72 G11B

H. 2 Cm



Inserto GN 2/3 in acciaio inox

Food pan, GN 2/3 18/10, stainless steel

V01 05 72 G23B

H. 6,5 Cm



Inserto GN 1/3 in acciaio inox

Food pan, GN 1/3 18/10, stainless steel

V01 05 72 G13B

H. 6,5 Cm



Inserto GN 1/2 in acciaio inox

Food pan, GN 1/2 18/10, stainless steel

V01 05 72 G12B

H. 6,5 Cm



Inserto GN 1/1 in porcellana

Food pan, GN 1/1, porcelain

305 21 52 557

H. 6,5 Cm



Inserto GN 1/1 in porcellana

Food pan, GN 1/1, porcelain

3052152672

H. 2 Cm



Inserto GN 2/3 in porcellana

Food pan, GN 2/3, porcelain

305 21 52 583

H. 6,5 Cm



Inserto GN 1/2 in porcellana

Food pan, GN 1/2, porcelain

305 21 52 581

H. 6,5 Cm



Inserto GN 1/3 in porcellana

Food pan, GN 1/3, porcelain

305 21 52 582

H. 6,5 Cm



Set minestre per scaldavivande rettangolare

Soup tureen set for rectangular chafing dish

Set de soupieres pour chafing dish rectangulaire

Set de soperas para chafing dish rectangular

Suppenchüsselset für Chafing Dish rechteckig

		Cm	In
305 05 52 626	Adattatore - Adapter	1/1	1/1
		Lt	Oz
305 05 15 796	Zuppiera - Soup tureen	4,2	142



Portavivande tondo in acciaio inossidabile

Round food pan, stainless steel
Bac rond en acier inox idable
Cubeta redonda en acero inox idable
Behälter rund, edelstahl rostfrei

	Ø Cm	Ø In
305 05 72 517	40	15,3/4



Portavivande tondo in porcellana

Round food pan, porcelain
Bac rond en porcelaine
Cubeta redonda en porcelana
Porzellanbehälter, rund

	Ø Cm	Ø In
305 21 52 559	40	15,3/4



Inserto scaldavivande tondo in porcellana

Food pan half round chafing dish, porcelain with divider
Bac double en porcelaine pour chafing dish rond
Cubeta en porcelana para chafing dish redondo
Porzellaneinsatz, 2tlg fur chafing dish rund

	Ø Cm	Ø In
305 21 71 951 (1 Pz.)	40	15,3/4



Portauovo per scaldavivande tondo in porcellana

Egg holder for round chafing dish, porcelain
Porte-oeufs en porcelaine pour chafing dish rond
Porta huevos en porcelana para chafing dish redondo
Porzellaneiereinsatz für chafing dish rund

	Cm	Ø In
305 21 71 950	40	15,3/4



Set zuppiera per scaldavivande tondo Cm 40

Soup tureen set for Cm 40 round chafing dish
Set de soupières pour chafing dish rond Cm 40
Set de soperas para chafing dish redondo Cm 40
Suppenchüsselset für Chafing Dish rund Ø Cm 40

	Ø Cm	Ø In
305 05 52 627 Adattatore - Adapter	40	15,3/4
	Lt	Oz
305 05 15 796 Zuppiera - Souptureen	4,2	142



Classica

Alzata rettangolare linea Classica

Classica rectangular stand
Présentoir rectangulaire Classica
Soporte rectangular Classica
Rechteckiger Ständer, Classica

	Cm	In	H Cm	H In
303 .. 52 702	28 x 49	11 x 19,1/4	21	8,1/4

Vassoio refrigerato - Thermal tray

305 .. 54 611 GN 1/1



Alzata tonda linea Classica

Classica round stand
Présentoir rond Classica
Soporte redondo Classica
Runder Ständer, Classica

	Ø Cm	Ø In	H Cm	H In
303 .. 52 703	22	8,5/8	21	8,1/4

Ciotola in porcellana - porcelain bowl

264 02 53 170 28 11



COD. 305 07..... acciaio argentato - electro-plated stainless steel (EPSS)
 COD. 305 03..... acciaio argentato e ottone - electro-plated stainless steel (EPSS) and brass
 COD. 305 05..... acciaio e ottone - stainless steel and brass
 COD. 305 55..... acciaio inossidabile - stainless steel

Distributore Aqva con alzata Classica

Aqva dispenser with Classica stand
 Distributeur Aqva avec support Classica
 Dispensador Aqva con soporte Classica
 Aqua Getränkespender mit Ständer Classica

	Ø Cm	H Cm	Ø In	H in
305 .. 52 712	27	63	10,5/8	24,8



Coppa punch con manici Rubans

Punch bowl with Rubans handles
 Bol à punch avec poignées Rubans
 Champañera con asas Rubans
 Punschale mit Griff Rubans

	Ø Cm	Lt	Ø In	Oz
310 00 43 602	50	20	19,3/4	700





Alzata frutta 2-3-4 piani

Fruit stand, 2-3-4-tier

Plat à fruits sur pied, 2-3-4 étages

Frutero, 2-3-4 pisos

Obstständler, 2-3-4 stufig

		Ø Cm	H Cm	Ø In	H In
310 00 42 564	(2 piani / 2 tier)	30/25	49	11,3/4-9,7/8	19,5/16
310 00 42 565	(3 piani / 3 tier)	40/30/25	69	15,3/4-11,3/4-9,7/8	27
310 00 42 577	(3 piani / 3 tier)	54/40/30	69	21,1/4-15,3/4-11,3/4	27
310 00 42 571	(4 piani / 4 tier)	54/40/30/25	90	21,1/4-15,3/4-11,3/4-9,7/8	35,3/8

COD. 303 07..... acciaio argentato - electro-plated stainless steel (EPSS)
 COD. 303 03..... acciaio argentato e ottone - electro-plated stainless steel (EPSS) and brass
 COD. 303 05..... acciaio e ottone - stainless steel and brass
 COD. 303 55..... acciaio inossidabile - stainless steel

Alzata frutta

Fruit stand
 Plat à fruits sur pied
 Frutero
 Obststände

	Ø Cm	Ø In
310 00 42 574	30	11,3/4
310 00 42 539	40	15,3/4
310 00 42 549	54	21,1/4



Alzata frutta

Fruit stand
 Plat à fruits sur pied
 Frutero
 Obststände

	Ø Cm	Ø In
310 00 42 535	30	11,3/4



Alzata torta

Cake stand
 Presentoir à gâteau x
 Soporte pastel
 Tortenplatte

	Ø Cm	Ø In
310 00 42 526	32	12,5/8



Portaburro tondo

Butter cooler, round
Beurrier rond
Mantequera redonda
Butterkühler, rund

	Ø Cm	H Cm	Ø In	H In
V77 05 09 T32	32	6	12,5/8	2,3/8



Portaformaggi / affettati rettangolare refrigerato - piano in polietilene

Rectangular cheese / cold cuts dish, thermal - Polyethylene board
Plateau fromage / charcuterie rectangulaire réfrigérant - Plaque en polyéthylène
Quesera rectangular refrigerante - Tabla de polietileno
Käse/Wurstwarenplatte - rechteckig, gekühlt, Platte aus Acryl

	Cm	In
V77 05 54 G11 R	53 x 32,5	20,7/8 x 12,3/4



Portaformaggi / affettati tondo refrigerato - piano in polietilene

Round cheese / cold cuts dish, thermal - Polyethylene board
Plateau fromage / charcuterie rond réfrigérant - Plaque en polyéthylène
Quesera redonda refrigerante - Tabla de polietileno
Käse/Wurstwarenplatte - rund, gekühlt, Platte aus Acryl

	Ø Cm	Ø In
V77 05 54 T46 R	46	18,1/8



COD. 303 07..... acciaio argentato - electro-plated stainless steel (EPSS)
COD. 303 03..... acciaio argentato e ottone - electro-plated stainless steel (EPSS) and brass
COD. 303 05..... acciaio e ottone - stainless steel and brass
COD. 303 55..... acciaio inossidabile - stainless steel

Classica

Caraffa vetro acqua frizzante con coperchio basculante

Sparkling water glass pitcher with smart lid

Carafe en verre à eau gazeuse

avec couvercle basculant

Jarra de vidrio agua con gas con tapa basculante

Wasser Karaffe (Kohlen säüve) mit Kippen Kappe

	Lt	Oz
305 05 08 549	1	35

Caraffa vetro con coperchio basculante

Water glass pitcher with smart lid

Carafe en verre avec couvercle basculant

Jarra de vidrio con tapa basculante

Wasser Karaffe mit Kippen Kappe

	Lt	Oz
305 05 08 548	1	35



Caraffa succhi con coperchio

Juice pitcher with lid

Carafe à jus avec couvercle

Jarra zumo con tapa

Saftkrug mit Deckel

	Lt	Oz
305 05 08 539	1,5	53



Caraffa termica

Insulated beverage server

Pot isotherme

Jarra térmica

Termische Karaffe

	Lt	Oz
305 05 08 540	0,60	21
305 05 08 541	1,00	35
305 05 08 542	1,50	53



Caraffa termica conica

Insulated beverage server, conical

Pot isotherme conique

Jarra térmica cónica

Thermische Karaffe, konisch

	Lt	Oz
305 05 08 557	0,30	10
305 05 08 558	0,60	21
305 05 08 559	1,00	35
305 05 08 560	1,50	53



COD. 303 07..... acciaio argentato - electro-plated stainless steel (EPSS)
 COD. 303 03..... acciaio argentato e ottone - electro-plated stainless steel (EPSS) and brass
 COD. 303 05..... acciaio e ottone - stainless steel and brass
 COD. 303 55..... acciaio inossidabile - stainless steel

Caraffa termica cilindrica

Thermal beverage server, cylindrical

Pot isotherme cylindrique

Jarra térmica cilíndrica

Termische Karaffe, cilindrische

Acciaio inossidabile - St. Steel

	Lt	Oz
305 05 08 540	0,60	21
305 05 08 541	1,00	35
305 05 08 542	1,50	53

305 42 08 ...	coperchio black - black lid
305 40 08 ...	coperchio copper - copper lid
305 41 08 ...	coperchio gold - gold lid



Caraffa termica conica

Thermal beverage server, conical

Pot isotherme conique

Jarra térmica cónica

Thermische Karaffe, konisch

Acciaio inossidabile - St. Steel

	Lt	Oz
305 05 08 557	0,30	10
305 05 08 558	0,60	21
305 05 08 559	1,00	35
305 05 08 560	1,50	53

305 42 08 ...	coperchio black - black lid
305 40 08 ...	coperchio copper - copper lid
305 41 08 ...	coperchio gold - gold lid





Sistema **Rail**

Rail System

Modularità in movimento
Modularity in motion



Rail



Carrello Rail rettangolare

Rail è il carrello modulare firmato Broggi, pensato per valorizzare ogni servizio buffet con stile, funzionalità e flessibilità. Disponibile in due formati, compatto e maxi, si integra perfettamente in qualsiasi contesto, dall'hôtellerie all'alta ristorazione. Struttura robusta, design essenziale e dettagli curati fanno di RAIL una soluzione pratica ed elegante per ogni esigenza operativa. I piani sono in legno nero verniciato opaco, incorniciati da un telaio in ferro, per un perfetto equilibrio tra raffinatezza e resistenza.

Rail trolley rectangular

"Rail is the modular trolley by Broggi, designed to elevate any buffet service with style, functionality, and flexibility. Available in two sizes—compact and maxi—it fits seamlessly into any setting, from hotels to fine dining establishments. Its robust structure, essential design, and refined details make RAIL a practical and elegant solution for every operational need. The shelves are made of matte black lacquered wood, framed by an iron structure, offering the perfect balance between sophistication and durability."



Carrello Rail rettangolare nero

Rail trolley rectangular black
 Chariot Rail rectangulaire noir
 Carro Rail rectangular negro
 Rechteckiger Servierwagen "Rail" Farbe Schwarz

	Cm	In
323 18 51 730	160 x 80 H. 90	63.0 x 31.5 H. 35.4



Carrello Rail rettangolare con ripiano forato + compensi

Rail trolley rectangular with perforated shelf + compensators
 Chariot Rail rectangulaire avec tablette perforée + compensateurs
 Carro Rail rectangular con estante perforado + compensadores
 Rechteckiger Servierwagen "Rail" Schwarz mit perforiertem Regal + Ausgleichsgewichte

	Cm	In
323 18 51 733	160 x 80 H. 90	63.0 x 31.5 H. 35.4
2 compensi inclusi / 2 compensators included		

Rail

Componibilità che arreda

La forza di Rail sta nella sua capacità di trasformarsi. Non è solo un carrello, ma un vero elemento d'arredo modulare, capace di adattarsi a stili e ambienti diversi grazie alla sua struttura componibile. Pannelli e cassetti diventano strumenti di stile e organizzazione: ogni dettaglio può essere scelto e combinato per creare una soluzione su misura, funzionale ma anche estetica. Il risultato è un prodotto che arreda con coerenza, esprimendo personalità e valorizzando lo spazio in cui si inserisce.

Design-driven modularity

Rail's true strength lies in its ability to transform. More than just a trolley, it is a fully modular furnishing element, capable of adapting to a variety of styles and spaces thanks to its flexible structure. Panels and drawers become tools of both organization and style: each detail can be selected and combined to create a tailored solution—functional and aesthetic at the same time. The result is a piece that furnishes with coherence, expresses personality, and enhances the environment it inhabits.



(A) Cassetti carrello Rail

Rail trolley drawers
Tiroirs pour chariot Rail
Cajónes para carro Rail
Schubladen für Servierwagen "Rail" mit Schienen

	Cm	In
B 200 45 17 31	74 x 75,8 H. 31	29.13 x 29.88 H. 12.21



Modulo angolare per carrello Rail

Corner module for Rail trolley
Module d'angle pour chariot Rail
Módulo angular para carro Rail
Winkelmodul für Servierwagen "Rail"

	Cm	In
323 04 52 737	80 x 80	31.5 x 31.5







Coperture

Covers
Couvertures
Cubiertas
Abdeckungen



(B) Copertura frontale superiore

Upper front cover
Couverture frontale supérieure
Cubierta frontal superior
Obere Frontabdeckung Farbe

	Cm	In
 323 04 52 719	152 x 37,8	59.84 x 14.88
 323 04 52 720	152 x 37,8	59.84 x 14.88
 323 04 52 721	152 x 37,8	59.84 x 14.88



(C) Copertura frontale inferiore

Lower front cover
Couverture frontale inférieure
Cubierta frontal inferior
Untere Vorderabdeckung Farbe

	Cm	In
 323 04 52 722	152 x 30,8	59.84 x 12.12
 323 04 52 723	152 x 30,8	59.84 x 12.12
 323 04 52 724	152 x 30,8	59.84 x 12.12



(D) Copertura laterale superiore

Upper side cover
Couverture latérale supérieure
Cubierta lateral superior
Obere Seitenabdeckung Farbe

	Cm	In
 323 04 52 725	75,6 x 35,8	29.76 x 14.09
 323 04 52 726	75,6 x 35,8	29.76 x 14.09
 323 04 52 727	75,6 x 35,8	29.76 x 14.09

(E) Copertura laterale inferiore

Lower side cover
Couverture latérale inférieure
Cubierta lateral inferior
Unterseitige Seitenabdeckung Farbe

	Cm	In
 323 04 52 728	75,6 x 30,8	29.76 x 12.12
 323 04 52 729	75,6 x 30,8	29.76 x 12.12
 323 04 52 730	75,6 x 30,8	29.76 x 12.12

3 colorazioni disponibili / Available in 3 colors



Rovere Affumicato

Oak
Chêne
Roble
Eiche



Noce Canaletto

Walnut
Noyer
Nogal
Nussbaum

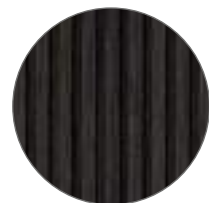

MDF Nero

Black MDF
MDF noir
MDF negro
MDF Schwarz

Rail

Possibili composizioni

La struttura modulare di Rail consente diverse personalizzazioni. È possibile configurarlo con cassetti nella parte inferiore, con pannelli applicati sopra o sotto, oppure con pannellature su tutta la superficie. I rivestimenti sono disponibili in tre finiture: rovere, noce oppure MDF nero, per adattarsi a ogni stile e esigenza operativa. La libertà compositiva rende ogni carrello unico, perfettamente coerente con l'identità del locale e il tipo di servizio.

Configuration options

Rail's modular design allows for multiple custom configurations. It can be equipped with drawers in the lower section, panels above or below, or fully paneled on all sides. Finishes are available in three options: oak, walnut, or black MDF—ensuring adaptability to any décor and operational need. This freedom of composition makes each trolley unique, perfectly aligned with the venue's identity and the type of service offered.



Cassetti

Drawers
Tiroirs
Calzoncillos
Schubladen

Ⓐ 2 cassetti
2 drawers



Coperture superiori e cassetti

Upper covers and drawers
Couvertures supérieures et tiroirs
Cubiertas superiores y cajones
Obere Abdeckungen und Schubladen

Ⓐ 2 cassetti
2 drawers

Ⓑ 1 copertura frontale superiore
1 upper front cover

Ⓓ 2 coperture laterali superiori
2 upper side covers



Coperture inferiori

Lower covers
Couvertures inférieure
Cubiertas inferior
Untere Abdeckungen

- (C) 1 copertura frontale inferiore
1 lower front cover
- (E) 2 coperture laterali inferiori
2 lower side covers



Coperture superiori e coperture inferiori

Upper covers and lower covers
Couvertures supérieures et couvertures inférieure
Cubiertas superiores y cubiertas inferior
Obere Abdeckungen und Untere Abdeckungen

- (B) 1 copertura frontale superiore
1 upper front cover
- (D) 2 coperture laterali superiori
2 upper side covers
- (C) 1 copertura frontale inferiore
1 lower front cover
- (E) 2 coperture laterali inferiori
2 lower side covers



Carrello Rail quadrato

Rail è il carrello modulare firmato Broggi, pensato per valorizzare ogni servizio buffet con stile, funzionalità e flessibilità. Disponibile in due formati, compatto e maxi, si integra perfettamente in qualsiasi contesto, dall'hôtellerie all'alta ristorazione. Struttura robusta, design essenziale e dettagli curati fanno di RAIL una soluzione pratica ed elegante per ogni esigenza operativa. I piani sono in legno nero verniciato opaco, incorniciati da un telaio in ferro, per un perfetto equilibrio tra raffinatezza e resistenza.

Rail trolley square

"Rail is the modular trolley by Broggi, designed to elevate any buffet service with style, functionality, and flexibility. Available in two sizes—compact and maxi—it fits seamlessly into any setting, from hotels to fine dining establishments. Its robust structure, essential design, and refined details make RAIL a practical and elegant solution for every operational need. The shelves are made of matte black lacquered wood, framed by an iron structure, offering the perfect balance between sophistication and durability."



Carrello Rail quadrato nero

Rail trolley square black
Chariot Rail carré noir
 Carro Rail cuadrado negro
 Quadratischer Servierwagen "Rail" Schwarz

	Cm	In
323 18 51 731	80 x 86 H. 90	31.5 x 33.9 H. 35.4



Carrello Rail quadrato con ripiano forato + compenso

Rail trolley square with perforated shelf + compensator
Chariot Rail carré avec tablette perforée + compensateur
 Carro Rail cuadrado con estante perforado + compensadore
 Quadratisches Servierwagen "Rail" Schwarz Regal mit Lochboden
 + Ausgleichsblenden

	Cm	In
323 18 51 732	80 x 86 H. 90	31.5 x 33.9 H. 35.4
1 compenso incluso / 1 compensator included		

Rail

Componibilità che arreda

La forza di Rail sta nella sua capacità di trasformarsi. Non è solo un carrello, ma un vero elemento d'arredo modulare, capace di adattarsi a stili e ambienti diversi grazie alla sua struttura componibile. Pannelli e cassetti diventano strumenti di stile e organizzazione: ogni dettaglio può essere scelto e combinato per creare una soluzione su misura, funzionale ma anche estetica. Il risultato è un prodotto che arreda con coerenza, esprimendo personalità e valorizzando lo spazio in cui si inserisce.

Design-driven modularity

Rail's true strength lies in its ability to transform. More than just a trolley, it is a fully modular furnishing element, capable of adapting to a variety of styles and spaces thanks to its flexible structure. Panels and drawers become tools of both organization and style: each detail can be selected and combined to create a tailored solution—functional and aesthetic at the same time. The result is a piece that furnishes with coherence, expresses personality, and enhances the environment it inhabits.



A Cassetto carrello Rail

Rail trolley drawer
Tiroir pour chariot Rail
Cajón para carro Rail
Schublade für Servierwagen "Rail" mit Schienen

	Cm	In
B 200 45 17 31	74 x 75,8 H. 31	29.13 x 29.88 H. 12.21



Modulo angolare per carrello Rail

Corner module for Rail trolley
Module d'angle pour chariot Rail
Módulo angular para carro Rail
Winkelmodul für Servierwagen "Rail"

	Cm	In
323 04 52 737	80 x 80	31.5 x 31.5







Coperture

Covers
Couvertures
Cubiertas
Abdeckungen



F Copertura frontale superiore

Upper front cover
Couverture frontale supérieure
Cubierta frontal superior
Obere Frontabdeckung Farbe

	Cm	In
 323 04 52 731	78 x 37,8	30.7 x 14.88
 323 04 52 732	78 x 37,8	30.7 x 14.88
 323 04 52 733	78 x 37,8	30.7 x 14.88



G Copertura frontale inferiore

Lower front cover
Couverture frontale inférieure
Cubierta frontal inferior
Untere Vorderabdeckung Farbe

	Cm	In
 323 04 52 734	78 x 30,8	30.7 x 12.12
 323 04 52 735	78 x 30,8	30.7 x 12.12
 323 04 52 736	78 x 30,8	30.7 x 12.12



D Copertura laterale superiore

Upper side cover
Couverture latérale supérieure
Cubierta lateral superior
Obere Seitenabdeckung Farbe

	Cm	In
 323 04 52 725	75,6 x 35,8	29.76 x 14.09
 323 04 52 726	75,6 x 35,8	29.76 x 14.09
 323 04 52 727	75,6 x 35,8	29.76 x 14.09

E Copertura laterale inferiore

Lower side cover
Couverture latérale inférieure
Cubierta lateral inferior
Unterseitige Seitenabdeckung Farbe

	Cm	In
 323 04 52 728	75,6 x 30,8	29.76 x 12.12
 323 04 52 729	75,6 x 30,8	29.76 x 12.12
 323 04 52 730	75,6 x 30,8	29.76 x 12.12

3 colorazioni disponibili - Available in 3 colors



Rovere Affumicato

Oak
Chêne
Roble
Eiche



Noce Canaletto

Walnut
Noyer
Nogal
Nussbaum

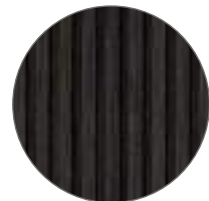

MDF Nero

Black MDF
MDF noir
MDF negro
MDF Schwarz

Rail

Possibili composizioni

La struttura modulare di Rail consente diverse personalizzazioni. È possibile configurarlo con cassetti nella parte inferiore, con pannelli applicati sopra o sotto, oppure con pannellature su tutta la superficie. I rivestimenti sono disponibili in tre finiture: rovere, noce oppure MDF nero, per adattarsi a ogni stile e esigenza operativa. La libertà compositiva rende ogni carrello unico, perfettamente coerente con l'identità del locale e il tipo di servizio.

Configuration options

Rail's modular design allows for multiple custom configurations. It can be equipped with drawers in the lower section, panels above or below, or fully paneled on all sides. Finishes are available in three options: oak, walnut, or black MDF—ensuring adaptability to any décor and operational need. This freedom of composition makes each trolley unique, perfectly aligned with the venue's identity and the type of service offered.



Cassetto

Drawer
Tiroir
Cajón
Schublade

- Ⓐ 1 cassetto
1 drawer



Coperture superiori e cassetto

Upper covers and drawer
Couvertures supérieures et tiroir
Cubiertas superiores y cajón
Obere Abdeckungen und Schublade

- Ⓐ 1 cassetto
1 drawer
- Ⓕ 1 copertura frontale superiore
1 upper front cover
- Ⓖ 2 coperture laterali superiori
2 upper side covers



Coperture inferiori

Lower covers
 Couvertures inférieure
 Cubiertas inferior
 Untere Abdeckungen

- ⓕ 1 copertura frontale inferiore
1 lower front cover
- ⓔ 2 coperture laterali inferiori
2 lower side covers



Coperture superiori e coperture inferiori

Upper covers and lower covers
 Couvertures supérieures et couvertures inférieure
 Cubiertas superiores y cubiertas inferior
 Obere Abdeckungen und Untere Abdeckungen

- ⓕ 1 copertura frontale superiore
1 upper front cover
- ⓓ 2 coperture laterali superiori
2 upper side covers
- ⓖ 1 copertura frontale inferiore
1 lower front cover
- ⓔ 2 coperture laterali inferiori
2 lower side covers



① Piano per mantenimento calore in vetroceramica

Glass ceramic heat retention top
Plan de maintien au chaud en vitrocéramique
Encimera para mantener el calor en vitrocerámica
Platte zur Wärmespeicherung in Glaskeramik

	Cm	In
323 05 52 014	70 x 38,5	27.6 x 15.2



② Sistema refrigerato con piano in vetro acidato

Refrigerated system with etched glass top
Système réfrigéré avec plan en verre dépoli
Sistema refrigerado con encimera en vidrio acidado
Kühlsystem mit satiniertes Glasplatte

	Cm	In
323 05 52 017	70 x 38,5	27.6 x 15.2



③ Piastra a induzione

Induction hob
Plaque à induction
Placa de inducción
Induktionskochfeld

	Cm	In
323 05 52 015	35x38,5	13.8 × 15.2 in



④ Piastra a induzione per Wok

Induction hob for wok
Plaque à induction pour wok
Placa de inducción para wok
Induktionsplatte für Wok

	Cm	In
323 05 52 016	35x38,5	13.8 × 15.2 in



⑤ Compenso in acciaio 18/10

Compensation 18/10 St. Steel
Compensation en acier 18/10
Compensación en acero 18/10
Edelstahl Platte 18/10

	Cm	In
323 05 52 018	35x38,5	13.8 × 15.2 in





⑥ Scaldavivande da incasso con coperchio in acciaio inox

Built-in chafing dish with St. Steel cover
 Chafing dish encastrable avec couvercle en acier inox
 Chafing dish para empotrar con tapa en acero inox
 Chafing Dish zum Einbauen mit Edelstahl Deckel



GN 1/1	Cm	H Cm
305 05 52 693	60,5 x 40,5	39,5

⑦ Scaldavivande da incasso con coperchio in acciaio inox / vetro

Built-in chafing dish with St. Steel / glass cover
 Chafing dish encastrable avec couvercle en acier inox / verre
 Chafing dish para empotrar con tapa en acero inox / vidrio
 Chafing Dish zum Einbauen mit Edelstahl / Glass Deckel

GN 1/1	Cm	H Cm
305 05 52 692	60,5 x 40	39,5

⑧ Compenso in legno per scaldavivande - GN 1/1

Wooden compensation for chafing dish - GN 1/1
 Compensation en bois pour réchauffeur - GN 1/1
 Compensación de madera para chafing dish - GN 1/1
 Holzunterlage für Warmhaltebehälter - GN 1/1

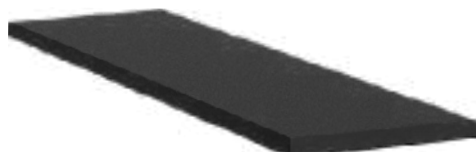

	Cm	In
323 04 52 738	11,5 x 38,5	4 1/2 x 15 1/8

9 Scaldavivande da incasso con coperchio in acciaio inox

Built-in chafing dish with St. Steel cover
 Chafing dish encastrable avec couvercle en acier inox
 Chafing dish para empotrar con tapa en acero inox
 Chafing Dish zum Einbauen mit Edelstahl Deckel



	Cm	H Cm
GN 2/3		
305 05 52 695	43 x 40	21

10 Scaldavivande da incasso con coperchio in acciaio inox / vetro

Built-in chafing dish with St. Steel / glass cover
 Chafing dish encastrable avec couvercle en acier inox / verre
 Chafing dish para empotrar con tapa en acero inox / vidrio
 Chafing Dish zum Einbauen mit Edelstahl / Glass Deckel

	Cm	H Cm
GN 2/3		
305 05 52 694	43 x 40	21

11 Compenso in legno per scaldavivande - GN 2/3

Wooden compensation for chafing dish - GN 2/3
 Compensation en bois pour réchauffeur - GN 2/3
 Compensación de madera para chafing dish - GN 2/3
 Holzunterlage für Warmhaltebehälter - GN 2/3



	Cm	In
323 04 52 739	29 x 38,5	11 1/2 x 15 1/8







Rail

Rail nasce per essere personalizzato

Rail is designed to be customized

Il piano superiore può essere predisposto con fori da 70×38,5cm o 140×38,5 cm, che accolgono moduli tecnici ad incasso: piastre a induzione, piani refrigerati o dimantenimento calore, progettati per integrarsi perfettamente nella struttura e garantire massima efficienza durante il servizio. È la modularità a rendere RAIL uno strumento professionale evoluto: componibile, trasformabile, sempre coerente con le esigenze del momento. Un carrello, molte configurazioni. Infinite possibilità operative.

The top surface can be configured with cut-outs measuring 70×38.5 cm or 140×38.5 cm, which accommodate built-in technical modules: induction hobs, refrigerated or heated surfaces, all engineered to integrate seamlessly into the structure and ensure maximum efficiency during service. Modularity is what makes RAIL an advanced professional tool: it is configurable, adaptable, and always aligned with current needs. One trolley, many configurations. Endless operational possibilities.



Piano manten. calore
Heat retention top
70 x 38,5 cm



Piano refrigerato
Refrigerated system
70 x 38,5 cm



Piastra induzione
Induction hob
35 x 38,5 cm



Piastra induzione wok
Induction hob for wok
35 x 38,5 cm



Compenso in acciaio
Compensation 18/10 st. st.
35 x 38,5 cm

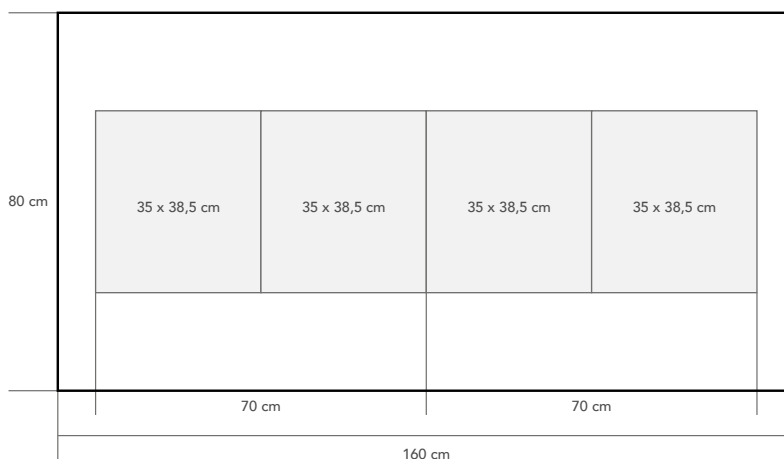
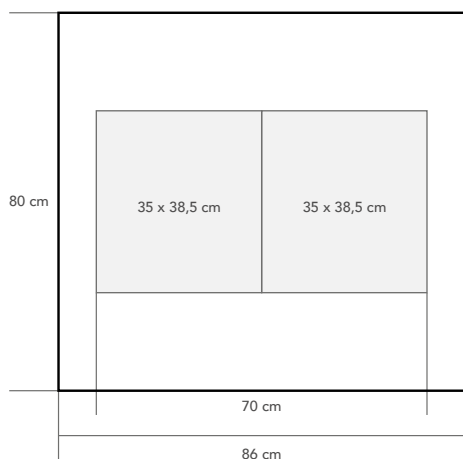



Rail nasce per essere personalizzato

Rail is designed to be customized

RAIL accoglie anche scaldavivande GN 1/1 e GN 2/3, con i relativi compensi, ampliando la gamma di soluzioni disponibili. Questa integrazione consente di mantenere le preparazioni alla giusta temperatura e di organizzare il servizio in modo pratico ed efficiente, sempre in coerenza con la logica modulare del sistema.

RAIL also accommodates built-in chafing dishes in GN 1/1 and GN 2/3 sizes, with their respective adapters, further expanding the range of available solutions. This integration keeps dishes at the right temperature and ensures a practical, efficient service, always in line with the system's modular logic.



Scaldavivande da incasso GN 1/1
GN 1/1 built-in chafing dish
60,5 x 40,5 cm



Compenso in legno GN 1/1
GN 1/1 wooden compensation
11,5 x 38,5 cm



Scaldavivande da incasso GN 2/3
GN 2/3 built-in chafing dish GN 2/3
43 x 40 cm



Compenso in legno GN 2/3
GN 2/3 wooden compensation GN 2/3
29 x 38,5 cm

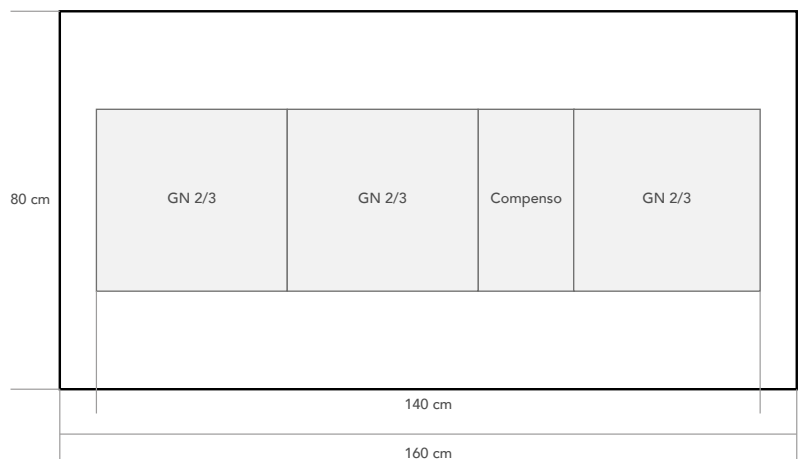
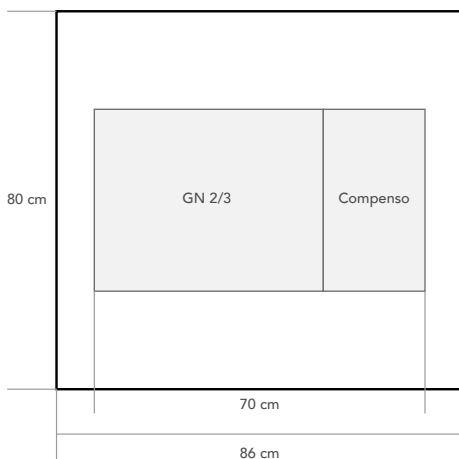
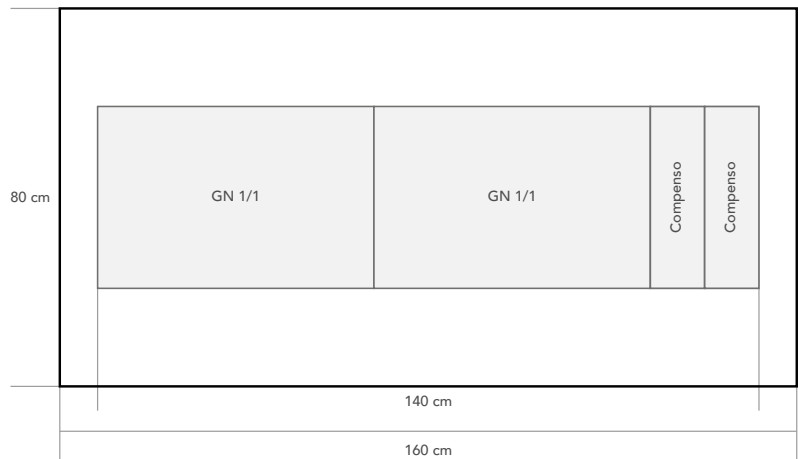
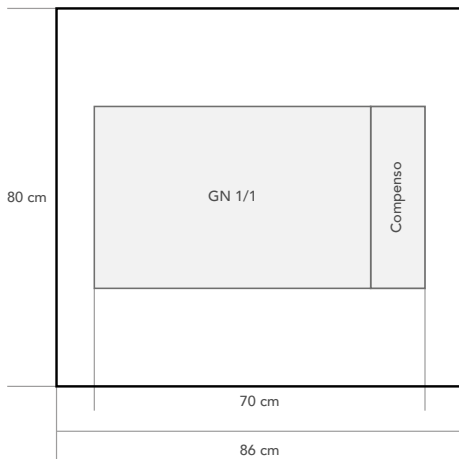

I nuovi carrelli PiGreco, con telaio in acciaio

inossidabile 18/10 e ripiani in legno verniciato opaco, regalano una vera e propria rivoluzione nel campo del servizio.

La presenza di sole due gambe diametralmente opposte permette una facilità di carico fino ad oggi mai sperimentata.

Le linee pulite, moderne ed eleganti, il design brevettato, lo stile accattivante e la cura nei minimi dettagli rendono PiGreco unico nel suo genere.

Disponibile nella versione nero opaco o, a richiesta, in legno chiaro naturale; i carrelli a 2 o 3 ripiani sono componibili e personalizzabili grazie alla vasta gamma di accessori.

The new PiGreco trolleys, with stainless steel structure and matte varnished wood tops, represent a real revolution in the service field.

Only two legs, diametrically opposite, allow easy loading, never experienced before. Clean lines, modern and elegant, patented design, appealing style and care of the smallest details, make PiGreco a one of a kind trolley.

It comes in matte black or, upon request, natural light wood; 2-tier and 3-tier trolleys are modular and customizable thanks to a wide accessories range.

Die neuen Wagen PiGreco, mit Edelstahl 18/10

Gestell und die Bretter aus matt lackiertem Holz, stellen eine echte Revolution im Service-Bereich dar.

Nur zwei Beine, diametral entgegengesetzt, erlauben eine leichte Beladung noch nie bis heute erlebt

Die saubere Linie, modern und elegant, das patentierte Design, ein gewinnendes Stil und eine Pflege in allen Einzelheiten machen PiGreco einzig in seiner Art

Lieferbar matt schwarz oder, auf Wunsch in natürlichem hellem Holz; die 2- und 3-stufige Wagen sind modular und personell gestaltet dank einer breiten Zubehörpalette

Les nouveau x chariots PiGreco, avec cadre en acier

inox idable 18/10 et étagères en bois laqué opaque, représentent une véritable révolution dans le domaine du service. La présence de deux supports, diamétralement opposés, permet une facilité de charge jamais expérimentée jusqu'aujourd'hui.

Les lignes essentielles, modernes et élégantes, le design breveté, le style charmant et le soigne dans les moindres détails rendent PiGreco unique en son genre.

Disponibile dans la version noir opaque ou, sur la demande, en bois clair naturel; les chariots avec 2 ou 3 étagères sont modulables et personnalisables grâce à la vaste gamme des accessoires.

Los nuevos carros de servicio PiGreco, con estructura en acero inoxidable 18/10 y estantes en madera barnizada opaca, representan una verdadera revolución en el campo del servicio.

La presencia de dos soportes solamente, diametralmente opuestos, permite una facilidad de carga nunca experimentada hasta ahora. Las líneas limpias, modernas y elegantes, el diseño patentado, el estilo cautivador y el cuidado de los más mínimos detalles hacen PiGreco único en su género.

Disponibile en la versión negro opaco o, a pedido, en madera clara natural; los carros de 2 o 3 niveles son modulares y personalizables gracias a la vasta gama de accesorios.



Carrelli **PiGreco**

Modern **and**
stylish **structures**



Carrello servire 2 ripiani

Service trolley, 2-tier
 Chariot de service 2 étagères
 Carro servizio 2 niveles
 Servierwagen, 2-stufig

	Cm	H Cm	In	H In
319 04 51 681	90 x 50	82	35,3/8 x 19,3/4	32,1/4



Carrello di servizio adeguato a qualsiasi utilizzo. Base a 2 ripiani alla quale si possono abbinare vari componenti per creare il carrello che meglio risponde alle vostre esigenze.

È dotato di ruote antivibrazione, pivotanti, di cui 2 con freno, adatte ad ogni tipo di pavimentazione. L'aspetto estetico, dalle linee pulite allo stile accattivante, rendono PiGreco unico nel suo genere.

Service trolley suitable for every use. A 2-tier base to which you can combine various components to create the trolley that best meets your requirements.

It is equipped with anti-vibration, pivoting wheels, 2 of which with brake. The aesthetic appearance, with clean lines and appealing style make PiGreco a one of a kind trolley.



Poggiapiatto estraibile in legno
 Wood removable tray



Pratica maniglia in acciaio inossidabile
 Stainless steel handles



Ruota pivotante rivestita con gomma antistatica
 Pivoting wheel with anti-static rubber

Carrello servire 3 ripiani

Service trolley, 3-tier
 Chariot de service 3 étagères
 Carro servizio 3 niveles
 Servierwagen, 3-stufig

	Cm	H Cm	In	H In
319 04 51 682	90 x 50	82	35,3/8 x 19,3/4	32,1/4



Carrello di servizio adeguato a qualsiasi utilizzo. Base a 3 ripiani alla quale si possono abbinare vari componenti per creare il carrello che meglio risponde alle vostre esigenze. Le due gambe agli angoli opposti creano uno spazio tale da agevolare la facilità di carico.

Service trolley suitable for any use. A 3-tier base to which you can combine various components to create the trolley that best meets your requirements. The two legs at opposite corners create a space that allow easy loading.



Telaio resistente in acciaio inossidabile
 Resistant stainless steel structure



Ripiani in legno massiccio verniciato
 Varnished solid wood tiers



Facilità di carico
 Easy loading



Vassoio rett. PiGreco Tea Time

PiGreco Rectangular Tea Time Tray
 Plateau rectangulaire Tea Time PiGreco
 Bandeja rectangular Tea Time PiGreco
 Time Tablett, rechteckig, PiGreco

	Cm	In
319 04 23 873	80 x 50 x h.5	31/2 x 19/2 x h.2



Top dolci/formaggi refrigerato

Pastry/cheese top, refrigerated
 Etagère à pâtisseries ou fromages réfrigérée
 Bandeja postres o quesos refrigerada
 Kühlaufsatz für Kuchen und Käse

	Cm	H Cm	In	H In
319 04 51 683	90 x 50	30	35,3/8 x 19,3/4	11,3/4

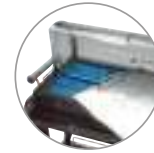

Vassoio estraibile in acciaio
 inossidabile con fori drenaggio condensa
 Stainless steel pull-out tray with holes
 for condensation



Top flambé a gas

Flambé top, gas
 Etagère flambé à gas
 Bandeja flambeado a gas
 Flambieraufsatz, Gas

	Cm	H Cm	In	H In
319 04 51 684	90 x 50	9,5	35,3/8 x 19,3/4	3,3/4



Top bar con ringhiera

Bar top with railing
 Etagère bar avec rack en acier
 Bandeja bar con barandilla
 Aufsatz für Barservierwagen mit Rand

	Cm	H Cm	In	H In
319 04 51 685	90 x 50	9,5	35,3/8 x 19,3/4	3,3/4
319 04 51 686	70 x 50	9,5	27,1/2 x 19,3/4	3,3/4



Top bar con ringhiera

Bar top with railing
 Etagère bar avec rack en acier
 Bandeja bar con barandilla
 Aufsatz für Barservierwagen mit Rand

	Cm	H Cm	In	H In
319 04 51 687	50 x 50	9,5	19,3/4 x 19,3/4	3,3/4
319 04 51 688	40 x 50	9,5	15,3/4 x 19,3/4	3,3/4



Vasca ghiaccio

Ice pan
Bac à glaçons
Cubeta hielo
Eisschale

	Cm	H Cm	In	H In
319 04 51 689	20 x 50	9,5	7,7/8 x 19,3/4	3,3/4



Tagliere acciaio con portacondimenti

Steel tray with condiment holder.
Planche perforée acier avec bac condiments
Planchita perforada acero con porta condimentos
Edelstahlbrett mit Soßenhalter

	Cm	H Cm	In	H In
319 04 51 690	20 x 50	8	7,7/8 x 19,3/4	3,1/8

(in appoggio sulla ringhiera del top bar)
(to be placed on the bar top railing)



Portabottiglie 3 posti

Bottle holder, triple
Porte-bouteilles 3 bouteilles
Porta botellas 3 botellas
Flaschenhalter, 3-fach

	Cm	H Cm	In	H In
319 04 51 691	20 x 50	9,5	7,7/8 x 19,3/4	3,3/4



Portaglacette completo 3 posti

Bottle cooler holder, triple
Support rafraîchisseur à bouteilles 3 bouteilles
Soporte enfriador botellas 3 enfriadores
Weinkühlerhalter, 3-fach

	Cm	H Cm	In	H In
319 04 51 692	20 x 50	21,5	7,7/8 x 19,3/4	8,1/2



Supporto per sorbettiere 2 posti

PiGreco stand for sherbet pots, double
Support pour 2 sorbetières
Soporte para 2 sorbeteras
Nur Halter für Sorbetshalter 2-fach schwarz

	Cm	H Cm	In	H In
319 04 51 693	20 x 50	19	7,7/8 x 19,3/4	7,1/2



Portasorbettiere completo 2 posti

Sherbet pots with stand, double
Support sorbetières avec 2 sorbetières
Soporte para sorbeteras con 2 sorbeteras
Sorbetshalter komplett, 2-fach

	Cm	H Cm	In	H In
319 04 51 694	20 x 50	19	7,7/8 x 19,3/4	7,1/2



Top dolci/formaggi refrigerato

Pastry/cheese top, refrigerated

Etagère à pâtisseries ou fromages réfrigérée

Bandeja postres o quesos refrigerada

Kühlaufsatz für Kuchen und Käse



	Cm	H Cm	In	H In
319 04 51 683	90 x 50	30	35,3/8 x 19,3/4	11,3/4



Top bar con ringhiera

Bar top with railing

Etagère bar avec rack en acier

Bandeja bar con barandilla

Aufsatz für Barservierwagen mit Rand



	Cm	H Cm	In	H In
319 04 51 685	90 x 50	9,5	35,3/8 x 19,3/4	3,3/4



Top flambé a gas

Flambé top, gas

Etagère flambé à gas

Bandeja flambeado a gas

Flambieraufsatz, Gas



	Cm	H Cm	In	H In
319 04 51 684	90 x 50	9,5	35,3/8 x 19,3/4	3,3/4





Top dolci/formaggi 2 piani refrigerato

Pastry/cheese refrigerated top, 2-tier
 Étagère à pâtisseries ou fromages réfrigérée
 Bandeja postres o quesos refrigerada
 Kühlaufsatz für Kuchen und Käse

	Cm	H Cm	In	H In
319 04 51 633	90 x 50	60	35,3/8 x 19,3/4	23 5/8

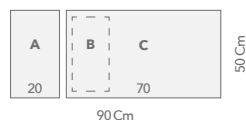

	Cm	H Cm	In	H In
A: 1 x 319 04 51 689	20 x 50	9,5	7,7/8 x 19,3/4	3,3/4
B: 1 x 319 04 51 690				
C: 1 x 319 04 51 686	70 x 50	9,5	27,1/2 x 19,3/4	3,3/4

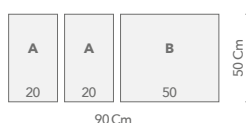

	Cm	H Cm	In	H In
A: 2 x 319 04 51 694	20 x 50	19	7,7/8 x 19,3/4	7,1/2
B: 1 x 319 04 51 687	50 x 50	9,5	19,3/4 x 19,3/4	3,3/4

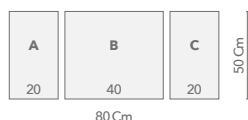

	Cm	H Cm	In	H In
A: 1 x 319 04 51 691	20 x 50	9,5	7,7/8 x 19,3/4	3,3/4
B: 1 x 319 04 51 688	40 x 50	9,5	15,3/4 x 19,3/4	3,3/4
C: 1 x 319 04 51 692	20 x 50	21,5	7,7/8 x 19,3/4	8,1/2

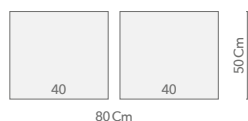

	Cm	H Cm	In	H In
2 x 319 04 51 688	40 x 50	9,5	15,3/4 x 19,3/4	3,3/4

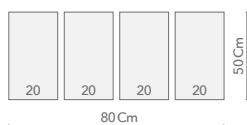

	Cm	H Cm	In	H In
4 x 319 04 51 691	20 x 50	9,5	7,7/8 x 19,3/4	3,3/4

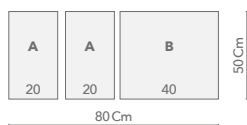

	Cm	H Cm	In	H In
A: 2 x 319 04 51 692	20 x 50	21,5	7,7/8 x 19,3/4	8,1/2
B: 1 x 319 04 51 688	40 x 50	9,5	15,3/4 x 19,3/4	3,3/4

Carrello cocktail

Cocktail trolley

Chariot cocktail

Carro cocktail

Cocktails Servierwagen

	Cm	H Cm	In	H In
319 04 51 699	50 x 90	91,5	35,3/8 x 19,3/4	36

Carrello per il servizio al tavolo ideale per la preparazione di cocktail di ogni tipo. Il carrello è dotato di top in legno con finiture e accessori in acciaio inox lucidato a specchio. Contiene portaglacette, portabottiglie, vasca ghiaccio e tagliere in acciaio con porta condimenti.

Service trolley, perfect to prepare every cocktail. The trolley is provided with wood top with mirror-polished, stainless steel finish and accessories. It comes with bottle cooler holder, bottle holder, ice pan and steel tray with condiment holder.



Tagliere in acciaio con portacondimenti
Steel tray with condiment holder



Portaglacette completo 3 posti
Bottle cooler holder, triple



Portabottiglie 3 posti
Bottle holder, triple

Carrello dolci/formaggi 3 ripiani refrigerato

Trolley for pastry/cheese, 3-tier refrigerated
Chariot pâtisseries/fromages 3 étagères réfrigéré
 Carro postres/queso 3 niveles refrigerado
 Servierwagen für Käse/Desserts mit Kühlung

	Cm	H Cm	In	H In
319 04 51 695	50 x 90	112	35,3/8 x 19,3/4	45,1/8

Carrello a 3 ripiani per il servizio al tavolo di dolci o formaggi oppure per il servizio a buffet, refrigerato con eutettici.
 Il carrello è dotato di top in legno con finiture ed accessori in acciaio inox lucidato a specchio.

3-tier service trolley for dessert or cheese or buffet service, with ice-pack cooling. The trolley is provided with wood top with mirror-polished stainless steel finish and accessories.

Vassoio estraibile in acciaio inossidabile con fori drenaggio condensa
 Stainless steel pull-out tray with holes for condensation

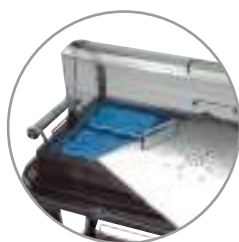

Top refrigerato con eutettici
 Ice-pack cooling top



Vassoio estraibile in acciaio inossidabile con fori drenaggio condensa
 Stainless steel pull-out tray with holes for condensation



Poggiapiatto estraibile in legno
 Wood removable tray

Carrello bar

Bar trolley
Chariot bar
Carro bar
Bar Servierwagen

	Cm	H Cm	In	H In
319 04 51 697	50 x 90	91,5	35,3/8 x 19,3/4	36

Carrello per il servizio al tavolo di liquori e digestivi. Il carrello è dotato di top in legno con ringhiera in acciaio inox lucidata a specchio.

Service trolley for liquor and drinks. The trolley is provided with wood top with mirror-polished stainless steel railing.



Top bar con ringhiera
Bar top with railing



Pratica maniglia in acciaio inossidabile
Practical stainless steel handle



Ruota pivotante rivestita con gomma antistatica
Pivoting wheel with anti-static rubber

Carrello vini/liquori

Wine/liquor trolley
 Chariot vins/liqueurs
 Carro vinos/licores
 Servierwagen für Likör

	Cm	H Cm	In	H In
319 04 51 698	50 x 90	91,5	35,3/8 x 19,3/4	36

Carrello per il servizio al tavolo di liquori e digestivi. Il carrello è dotato di top in legno con ringhiera in acciaio inox lucidata a specchio. Il carrello include anche porta bottiglie e porta glacettes.

Service trolley for liquor and drinks. The trolley is provided with wood top with mirror polished stainless steel railing. It also comes with bottle holder and bottle cooler holder.



Top bar con ringhiera
 Bar top with railing



Portaglacettes completo 3 posti
 Bottle cooler holder, triple



Portabottiglie 3 posti
 Bottle holder, triple

Carrello sorbetti

Sherbet trolley

Chariot sorbets

Carro sorbetes

Servierwagen mit Etagen für Speiseeis und Sorbett

	Cm	H Cm	In	H In
319 04 51 700	50 x 90	101	35,3/8 x 19,3/4	39,3/4

Carrello per il servizio al tavolo di gelato e sorbetti. Il carrello è dotato di top in legno con finiture ed accessori in acciaio inox lucidato a specchio. La sorbettiera è isoterma, a doppio corpo.

Service trolley for ice creams and sherbets. The trolley is provided with wood top with mirror-polished stainless steel finish and accessories. The sherbet pot is isothermal, double-wall.



Top bar con ringhiera
Bar top with railing



Portasorbettiere completo 2 posti
Sherbet pots with stand, double



Facilità di carico
Easy loading

Carrello flambé

Flambé trolley
Chariot flambé
Carro flameado
Flambierwagen

	Cm	H Cm	In	H In
319 04 51 696	50 x 90	91,5	35,3/8 x 19,3/4	36

Carrello per il servizio al tavolo.
Il piano di lavoro è in acciaio inox. Il piano di servizio inferiore ha un portabottiglie laterale con finiture in acciaio inossidabile. Il fornello sul piano superiore, con dispositivo di accensione e regolatore manuale di fiamma, è l'ideale per preparare un perfetto flambé.

Flambé service trolley. The working top is stainless steel. The lower service top has a side bottle opener with stainless steel finish. The burner on the upper top, with ignition device and flame adjuster, is the ideal to prepare a perfect flambé!



Fuoco con regolatore di fiamma
Flambé top



Piano in acciaio Inox
Stainless steel tier



Portabottiglie 3 posti
Bottle holder, triple



Carrelli Linea



Carrello Gueridon Linea

Linea gueridon trolley
Chariot Gueridon Linea
Carro Gueridon Lineay
Linea Gueridon-Wagen

	Cm	H Cm	In	H In
327 18 51 001	70 x 35	73	27,1/2 x 13,3/4	28,3/4



Carrello Gueridon Linea

Linea gueridon trolley
Chariot Gueridon Linea
Carro Gueridon Lineay
Linea Gueridon-Wagen

	Cm	H Cm	In	H in
327 18 51 002	80 x 50	82	31,1/2 x 19,3/4	32,1/4



Top Bar Linea

Linea bar top
 Dessus à bar Linea
 Encimera bar Linea
 Linea-Baroberteil

	Cm	In
327 18 51 010	70 x 35	27,1/2 x 13,3/4
327 18 51 011	80 x 50	31,1/2 x 19,3/4

**Top Pane Linea**

Linea bread top
 Dessus à pain Linea
 Encimera pan Linea
 Linea Brotaufsatz

	Cm	In
327 05 51 012	70 x 35	27,1/2 x 13,3/4

**Top Dolci Linea**

Linea dessert top
 Dessus à dessert Linea
 Encimera postres Linea
 Linea Dessertaufsatz

	Cm	In
327 05 51 013	70 x 35	27,1/2 x 13,3/4



Carrello completo pane

Complete trolley for bread

Chariot complet à pain

Carro completo pan

Kompletter Servierwagen für Brot

	Cm	In
327 18 51 031	70 x 35	27,1/2 x 13,3/4





Carrello completo bar

Complete trolley for bar service

Chariot complet à bar

Carro completo bar

Kompletter Servierwagen für den Barservice

	Cm	In
327 18 51 030	70 x 35	27,1/2 x 13,3/4
327 18 51 040	80 x 50	31,1/2 x 19,3/4



Carrello completo dolci/formaggi

Complete trolley for dessert/cheese

Chariot complet à dessert/fromages

Carro completo postres/quesos

Kompletter Servierwagen für Dessert & Käse

	Cm	In
327 18 51 032	70 x 35	27,1/2 x 13,3/4

I carrelli della linea Classica di Broggi sono realizzati

in legno massello di faggio verniciato con tinta a base di acqua nel rispetto della normativa europea in materia di idoneità al contatto con gli alimenti. La struttura del carrello, monoblocco ed autoportante, è molto robusta. La lavorazione artigianale è effettuata con l'utilizzo di macchine CNC e le parti metalliche sono realizzate in acciaio inossidabile AISI 304. Tutta la gamma è fornita nella classica ed elegante colorazione mogano Broggi. Hanno 4 ruote pivotanti da 125 mm di diametro con freno di stazionamento meccanico e rivestimento in silicone morbido ed adatte a superare le asperità del pavimento. È possibile produrre versioni in colori speciali su richiesta del cliente con un sovrapprezzo da stabilire. Altrettanto su richiesta del cliente è possibile realizzare versioni speciali dei carrelli con funzioni diverse. Ogni carrello è fornito di imballo singolo e pallettizzato.

Classica trolleys by Broggi are made from solid

beechwood, varnished using water-based paints in accordance with European regulations on suitability for food contact. The freestanding, one-piece frame of the trolley is very sturdy. CNC machines are used for a careful manufacturing process and metal parts are made of AISI 304 stainless steel. The entire range comes in the classic and elegant Broggi mahogany colour. The trolley features four Ø125-mm swivel casters plus mechanical brake and a soft silicone coating, suitable to adjust to uneven and rugged floors. Upon request trolleys in special colours can be made at a surcharge to be defined. Special trolley versions featuring different functions can also be made upon request. Each trolley is delivered in a single package and palletised.

Die Servierwagen der Linie Classica von Broggi sind

aus massivem Buchenholz, lackiert mit Farblack auf Wasserbasis nach den Vorgaben der europäischen Richtlinie für Gegenstände, die mit Lebensmitteln in Berührung kommen. Der Servierwagen zeichnet sich durch eine sehr robuste, selbsttragende Blockstruktur aus. Die handwerkliche Fertigung erfolgt unter dem Einsatz von CNC Maschinen, die Metallteile sind aus rostfreiem Stahl AISI 304. Die gesamte Serie steht im klassisch eleganten Farbton Mahagoni Broggi zur Verfügung. Der Wagen hat 4 Drehräder von 125 mm Durchmesser mit mechanischer Feststellbremse und weicher Silikonbeschichtung, die für alle Arten von Fußböden geeignet ist. Nach Kundenwunsch können Ausführungen in anderen Farben gegen Aufschlag nach Vereinbarung hergestellt werden. Außerdem sind spezielle Kundenanfertigungen von Servierwagen mit verschiedenen Funktionen möglich. Jeder Wagen wird einzeln verpackt auf Palletten geliefert.

Les chariots de la ligne Classica de Broggi sont réalisés

en bois de hêtre verni avec une peinture à base d'eau en conformité avec la réglementation européenne en matière d'aptitude au contact avec les aliments. La structure du chariot, monobloc et autoportante, est très solide. Le travail artisanal est effectué à l'aide de machines CNC et les pièces métalliques sont réalisées en acier inox AISI 304. Toute la gamme est fournie dans la classique et élégante couleur acajou Broggi. Ils ont 4 roues pivotantes de 125 mm de diamètre avec frein de stationnement mécanique et revêtement en silicone souple et appropriées pour surmonter les aspérités du plancher. Il est possible de produire des versions dans des couleurs spéciales à la demande du client avec un supplément à fixer. Toujours à la demande du client, il est possible de réaliser des versions spéciales des chariots avec des fonctions différentes. Chaque chariot est équipé d'emballage individuel et palettisé.

Los carros de la línea Classica de Broggi son

elaborados con madera maciza de haya barnizada con tinte a base de agua en el respeto de la normativa europea en materia de idoneidad para el contacto con los alimentos. La estructura del carro, monoblock y autoportante, es muy robusta. La elaboración artesanal se efectúa con el empleo de máquinas CNC y las partes metálicas son realizadas con acero inoxidable AISI 304. Toda la gama es suministrada en la clásica y elegante tonalidad caoba Broggi. Tienen 4 ruedas pivotantes de 125 mm de diámetro con freno de estacionamiento mecánico y revestimiento de silicona blanda adecuadas para superar las asperezas del piso. Es posible producir versiones de colores especiales a solicitud del cliente con un sobreprecio a establecer. Igualmente a solicitud del cliente es posible realizar versiones especiales de los carros con funciones diversas. Cada carro está dotado de embalaje singular y palletizado.

Carrelli
Classica



Carrello bolliti e arrosti

Roast beef and boiled meet trolley
Table roulante à boeuf et plat du jour
Carro para carne asada y cocidos
Fleisch-Menüwagen

Carrello per servire al tavolo i bolliti, con due portavivande grandi e uno più stretto, che possono essere regolabili in altezza e consentono di tagliare i bolliti senza toglierli dalla vasca.

Trolley to serve boiled meat, with two big food pans and a narrow one that can be adjusted in height, allowing to cut the meat without taking it out from the pan.

Carrello arrosti composto da tagliere in corian e due contenitori per salsa 14 x 14 Cm H. 12 Cm.

Roast beff trolley composed of corian carving board and two sauce container 14 x 14 Cm H. 12 Cm.



Poggiapiatto ribaltabile in acciaio inossidabile
Stainless steel plate stand, folding



Termostato regolabile e termometro digitale
Adjustable thermostat and digital thermometer



Supporto portacoltelli estraibile
Pull-out knife holder



Carrello arrosti

Roast beef trolley
 Table roulante à boeuf
 Carro para carne asada
 Fleischwagen

	Cm	H Cm
318 04 51 528	96 x 58	97
	In	H In
	37,7/8 x 22,7/8	38,1/4



Carrello bolliti

Boiled meat trolley
 Table roulante à plat du jour
 Carro para cocidos
 Menüwagen

	Cm	H Cm
318 04 51 522	96 x 58	97
	In	H In
	37,7/8 x 22,7/8	38,1/4

Carrello refrigerato ventilato

Ventilated refrigerated trolley
 Table roulante réfrigérée ventilée
 Carro refrigerado ventilado
 Wagen, mit Gelüfteter Kühlung

	Cm	H Cm	In	H In
318 04 51 581 Refrigerato / Refrigerated	92 x 52	105	43,1,1/4 x 23,5/8	43,114

Struttura in legno massello con piani impiallacciati. Vasca in acciaio inox AISI 304, dimensioni mm 700 x 395 x 90h. Foro sul fondo vasca per scarico condensa. Rubinetto per scarico acqua. Cupola in plexiglass semicilindrica con apertura su due lati. Pannello comandi con termostato digitale ed interruttore di accensione con spia luminosa. Tensione rete 230 Volt monofase 50/60hz. Cavo elettrico spiralato. Potenza 152 W. Temperatura di esercizio compresa tra 4°C e 10°C. Condensatore 3W. Ruote pivotanti mm 125 di cui due con freno. Dimensioni massime Cm 92 x 52 x 105h.

*Solid wood structure with veneer decks
 AISI 304 stainless steel pan with dimensions mm 700 x 395 x 90h.
 Condense outlet hole on the bottom.
 Water outlet tap.
 Plexiglass semi-cylindrical dome cover with opening on two sides.
 Operation panel with digital thermostat and power switch with Indicator light.
 230 Volt voltage, single phase 50/60hz
 Electric spiral cable.
 Power 152 W.
 Operating temperature between 4°C and 10°C.
 3W evaporator.
 Pivoting wheels mm 125, with two brakes.
 Maximum dimensions Cm 92 x 52 x 105h.*



Piano d'appoggio estraibile
 Pull-out top deck



Bordo metallico antiurto
 Shockproof metal edge



Cloche in plexiglass a due elementi semicircolari rientranti
 Plexiglass dome with two semicircular re-entering elements
 Apribile su ambo i lati
 Opening in both directions

Carrello flambé a gas

Flambé trolley
Table roulante à flambée
Carro para flameado
Flambierwagen

	Cm	H Cm	In	H In
318 04 51 539	90 x 52	90	35,3/8 x 20,1/2	35,3/8

Carrello per il servizio del flambé al tavolo. Il piano di lavoro è in corian. Il piano di servizio inferiore ha una ringhiera di protezione ed è presente un portabottiglie laterale in acciaio inossidabile.

Il fornello ha la griglia asportabile ed il bruciatore ha un dispositivo di sicurezza termocoppia secondo la normativa CE, vano portabombola in legno, dispositivo di accensione piezoelettrico e regolatore di fiamma. È disponibile in legno color ebano.

*Flambé service trolley.
The working deck is corian.
The service lower deck has a protective barrier and a side stainless steel bottle holder.
The stove has a removable grate and the burner has a thermocouple security device complying with CE regulations, a wooden gas cylinder cabinet, a piezoelectric ignition device and a flame adjuster.
It is available in ebony colour wood.*



Cestello porta bottiglie / spezie
in acciaio inossidabile
Stainless steel bottle / spice holder



Fuoco con griglia asportabile
Stove with removable grate



Dispositivo di accensione piezoelettrico
e regolatore di fiamma
Piezoelectric ignition device
and flame adjuster

Classica

Carrello Omicron

Omicron trolley

Table roulante Omicron

Carro Omicron

Omicron Servierwagen

	Cm	H Cm	In	H In
318 04 51 680	92 x 52	120	36,1/4 x 20,1/2	47,1/4

Carrello per il servizio di dolci o formaggi. L'estrema maneggevolezza e le dimensioni contenute rendono il carrello adatto al servizio tra i tavoli. Cloche in plexiglass con apertura bilaterale. Il piano, refrigerato con piastre eutectiche, è ad avanzamento automatico con apertura cloche. Ruote pivotanti di cui due con freno.

Cheese and dessert trolley

Ex treme manageability and small dimensions make it ideal for table service. Plexiglass cloche with two sides opening. The top, refrigerated with ice packs, slides automatically by opening the cloche. Pivoting wheels, two of which with brake with barrier.



Maniglia in acciaio inox
Stainless steel handle



Piano ad avanzamento automatico
Automatic sliding top



Piano refrigerato con piastre eutectiche
Top refrigerated with ice packs



Vassoio estraibile in acciaio inossidabile con fori drenaggio condensa
Stainless steel pull-out tray with holes for condensation

Carrello Sigari

Cigar trolley

*Chariot à cigares**Carro de servicio para puros**Servierwagen mit Zigarrenhalter*

	Cm	H Cm	In	H In
318 04 51 678	92 x 52	98	36,1/4 x 20,1/2	32,1/4

Con alzata liquori

318 04 51 679	92 x 52	125	36,1/4 x 20,1/2	49,1/4
---------------	---------	-----	-----------------	--------



Carrello per il servizio di sigari.

Cassetta sigari umidificata, realizzata in legno di cedro, vetrine in vetro con chiusura di sicurezza, umidificatore professionale, igrometro analogico per il controllo dell'umidità.

Il carrello, con l'aggiunta del top bar/liquori e alzata per calici, diventa l'ideale anche per il servizio di liquori.

Ruote pivotanti di cui due con freno.

Cigar trolley.

Cigar humidifier box , cedar wood, glass windows with safety lock, analog hygrometer for humidity control.

The trolley, with the bar/liqueur top and the goblet top, is the ideal for liqueur service. Pivoting wheels, two of which with brake.



Cassette sigari umidificate in legno di cedro
Cigar humidifier boxes, cedar wood



Igrometro analogico per il controllo dell'umidità
Analog hygrometer for humidity control



Vetrine con chiusure di sicurezza
Glass windows with safety lock

Carrello servire champagne tondo

Round champagne service trolley
Table roulante de service à champagne
Carro de servicio para champán
Servierwagen für Champagne. rund

	Ø Cm	H Cm	Ø In	H In
318 04 51 583	83	83	32,3/4	32,3/4

Coppa champagne Rubans non inclusa
 Punch baul not included

Coppa punch con manici Rubans

Punch bowl with Rubans handles
Bol à punch avec poignées Rubans
Champañera con asas Rubans
Punchschale mit Griff Rubans

	Ø Cm	Lt	Ø In	Oz
310 00 43 602	50	30	19,3/4	1014

Carrello tondo per il servizio di champagne di ø 83 cm.
 Il carrello ha 16 fori per bicchieri del ø di 9 cm e lo spazio per posizionare una coppa champagne.
 Ideale per il servizio al tavolo di champagne e non solo.
 Ruote pivotanti di cui due con freno.

*Round champagne trolley, ø 83 cm.
 The trolley has 16 holes for glasses, ø 9 cm, and room for a champagne bowl.
 Ideal for table service of champagne and more. Pivoting wheels, two of which with brake.*



Coppa champagne Rubans Ø Cm50
 Rubans champagne bowl, Ø Cm50



Piano di servizio inferiore con ringhiera di protezione
 Lower service deck with protective barrier



Sede alloggio bicchieri
 Champagne glass seat

Carrello tondo Liquori

Liquor trolley, round
 Chariot rond à liqueurs
 Carro redondo licores
 Spirituosenwagen, rund

	Cm	H Cm	In	H In
318 04 51 717	83	83	32,7	32,7



Bordo metallico antiurto
 Shock proof metal edge



Piano d'appoggio estraibile
 Pull-out top deck



Piano di servizio inferiore
 con ringhiera di protezione
 Lower service deck with
 protective barrier

Classica

Carrello servire

Service trolley
Table roulante de service
Carro de servicio
Servierwagen

	Cm	H Cm	In	H In
318 04 51 519	92 x 52	98	36,1/4 x 20,1/2	32,1/4

Carrello di servizio, funzionale per tutti gli utilizzi. È in legno color ebano e può essere dotato di tops diversi, specifici per l'uso. Il carrello servire può diventare carrello per presentazione del pesce, carrello bar liquori, carrello dolci e formaggi refrigerato, carrello per insalata ed antipasti, carrello per gelati e sorbetti.

Service trolley, functional for all uses. It is in ebony colour wood, and can be provided with different specific tops. The service trolley can be a fish display trolley, a liquor trolley, a refrigerated trolley for pastry and cheese, a salad and hors d'oeuvre trolley, or an ice-cream and sherbet trolley.



Maniglie in acciaio inox
Stainless steel handles



Ruota pivotante rivestita
con gomma antistatica
Pivoting wheel with
anti-static rubber tyre



Piano di servizio inferiore
con ringhiera di protezione
Lower service deck with
protective barrier

Carrello servire 3 piani

Service trolley, 3-tier
 Chariot de service 3 étagères
 Carro servicio 3 niveles
 Servierwagen, 3-stufig

	Cm	H Cm	In	H In
318 04 51 646	92 x 52	98	36,1/4 x 20,1/2	32,1/4

Il nuovo carrello di servizio con tre ripiani, funzionale per tutti gli utilizzi.
 È in legno color ebano e può essere dotato di tops diversi, specifici per l'uso.

*The new 3-shelves service trolley, functional for all uses.
 It is in ebony colour wood, and can be provided with different specific tops.*



Bordo metallico antiurto
 Shock proof metal edge



Piano d'appoggio estraibile
 Pull-out top deck



Piano di servizio inferiore
 con ringhiera di protezione
 Lower service deck with
 protective barrier

Classica



Top bar / liquori con alzata per calici per carrello servire

Service trolley liquor top with goblet stand

318 04 51 526	Cm 84 x 45	H Cm 46	In 33 x 17,3/4	H In 18,1/8
---------------	---------------	------------	-------------------	----------------



Top bar / liquori per carrello servire

Service trolley liquor top

318 04 51 520	Cm 84 x 45	In 33 x 17,3/4
---------------	---------------	-------------------



Top gelati e sorbetti per carrello servire

Service trolley ice-cream and sherbet top

318 04 51 542	Cm 84 x 45	In 33 x 17,3/4
---------------	---------------	-------------------



Top servire liquori

Liquor service top

318 04 51 705	Cm 84 x 45	In 33 x 17,3/4 in
---------------	---------------	----------------------



Carrello servire

Service trolley with pull-out top deck

318 04 51 519	Cm 92 x 52	H Cm 82	In 36,1/4 x 20,1/2	H In 32,1/4
---------------	---------------	------------	-----------------------	----------------



Top refrigerato per presentazione pesce per carrello servire

Service trolley refrigerated top for fish display

	Cm	In
318 04 51 543	84 x 45	33 x 17,3/4



Top dolci e formaggi refrigerato per carrello servire

Service trolley refrigerated top for pastry and cheese

	Cm	H Cm	In	H In
318 04 51 521	79 x 44	29	31,1/8 x 17,3/8	11,1/2



Top pasticceria 2 piani refrigerato per carrello servire

Dessert refrigerated top for service trolley, 2-tier

	Cm	H Cm	In	H In
318 04 51 675	76 x 42	52	30 x 16,1/2	20,1/2



Carrello servire 3 piani

Service trolley with pull-out top deck

	Cm	H Cm	In	H In
318 04 51 646	92 x 52	82	36,1/4 x 20,1/2	32,1/4

Carrello servire pasticceria/formaggi

Service trolley with refrigerated top for cheese

Table roulante de service avec étagère à fromages réfrigérée

Carro de servicio con bandeja para quesos refrigerante

Servierwagen mit Etage für Käse mit Kühlung

318 04 51 547 Refrigerato / Refrigerated

Cm	H Cm	In	H In
92 x 52	112	36,1/4 x 20,1/2	44

Carrello per il servizio al tavolo di dolci o formaggi oppure per il servizio a buffet, refrigerato con eutettici. Il carrello è dotato di top in legno color ebano con finiture e accessori in acciaio inox lucidato a specchio.

Service trolley for cheese and pastry or buffet service, with ice-pack cooling. The trolley is provided with an ebony colour top, with mirror-polished stainless steel finishing and accessories.



Piano d'appoggio estraibile
Pull-out top deck



Set dolci e formaggi
Pastry and cheese set



Vassoio estraibile in acciaio inossidabile con fori drenaggio condensa
Stainless steel pull-out tray with holes for condensation

Carrello servire con top gelati e sorbetti

Service trolley with ice-cream and sherbet top

Table roulante de service avec étagère à glaces et sorbets

Carro de servicio con bandeja para helados y sorbetes

Servierwagen mit Etage für Speiseeis und Sorbett

	Cm	H Cm	In	H In
318 04 51 549	92 x 52	120	36,1/4 x 20,1/2	47,1/4

Carrello per il servizio al tavolo di gelato e sorbetti. Il carrello è dotato di top in legno color ebano con finiture e accessori in acciaio inossidabile lucidato a specchio. La sorbettiera è isotermica, a doppio corpo.

Service trolley for ice-creams and sherbets. The trolley is provided with ebony colour wooden top, mirror-polished stainless steel finishing and accessories. The sherbet pot is isothermal, double-wall.



Sorbettiera isotermica
Isothermal sherbet pot



Piano con 4 sorbettiere
Deck with 4 sherbet pots



Piano d'appoggio estraibile
Pull-out top deck

Carrello servire con top refrigerato per presentazione pesce

Service trolley with refrigerated top for fish display
Table roulante de service avec étagère réfrigérée à poisson
Carro de servicio con bandeja refrigerante para pescado
Servierwagen mit Etage für Fisch mit Kühlung

	Cm	H Cm	In	H In
318 04 51 544	92 x 52	85	36,1/4 x 20,1/2	33,1/2

Carrello per la presentazione del pesce fresco, refrigerato direttamente con ghiaccio. Il carrello è dotato di top in legno color ebano e di piano inferiore con ringhiera.

Trolley for fresh fish display with ice cooling. The trolley is provided with ebony colour wooden top and lower deck with barrier.



Vasca estraibile in acciaio
Pull-out stainless steel pan



Piano d'appoggio estraibile
Pull-out top deck



Refrigerazione con ghiaccio
Ice cooling

Carrello servire con top bar / liquori e alzata per calici

Service trolley with liquor top and goblet stand

Table roulante de service avec étagère à liqueurs et tablette pour verres à pied

Carro de servicio con bandeja para licores y bandejita para copas

Servierwagen mit Etage für Likör und Gläser

	Cm	H Cm	In	H In
318 04 51 546	92 x 52	127	36,1/4 x 20,1/2	50

Carrello per il servizio al tavolo di liquori e digestivi. Il carrello è dotato di top in legno color ebano con finiture e accessori in acciaio inox lucidato a specchio. Pratico anche nella versione con l'alzata per calici con ringhiera di protezione.

Service trolley for liquor and digestives. The trolley is provided with ebony colour wooden top, mirror-polished stainless steel finishing and accessories. It is practical also in its version with the goblet stand with protective barrier. It is practical also in its version with the goblet stand with protective barrier.



Alzata per calici con ringhiera di protezione
Goblet stand with protective barrier



Ancoraggio a rotaia per calici
Rail fixing for goblets



Ruota pivotante rivestita con gomma antistatica
Pivoting wheel with anti-static rubber tyre

Classica

Carrello servire con top bar

LiquoriService trolley with liquor top
Table roulante de service avec étagère à liqueurs
Carro de servicio con bandeja para licores
Servierwagen mit Etage für Likör

	Cm	H Cm	In	H In
318 04 51 545	92 x 52	100	36,1/4 x 20,1/2	39,1/2

Carrello per il servizio al tavolo di liquori e digestivi. Il carrello è dotato di top in legno color ebano con finiture e accessori in acciaio inox lucidato a specchio.

Service trolley for liquor and digestives. The trolley is provided with ebony colour wooden top, mirror-polished stainless steel finishing and accessories.



Piano di servizio inferiore
Lower service deck



Piano d'appoggio estraibile
Pull-out top deck



Ringhiera di protezione superiore e maniglie in acciaio inox
Top deck protective barrier with stainless steel handles

Carrello Gueridon lusso

Gueridon trolley, de lu x e

Table roulante guéridon de lu x e

Carro queridon lujo

Gueridonwagen De Lu x e

	Cm	H Cm	In	H In
318 04 51 524	78 x 48	80	30,3/4 x 19	31,1/2
318 04 51 662	70 x 35	74	27,1/2 x 13,3/4	29,1
318 04 51 661	50 x 35	74	27,1/2 x 13,3/4	29,1

Carrello per il servizio al tavolo di dolci, pesce o formaggi, oppure per il servizio a buffet.

Service trolley for pastry, fish, cheese or buffet.



Gamba sagomata deluxe
Deluxe shaped leg



Piano inferiore con bordo
Lower deck with edge



Ruota pivotante rivestita
con gomma antistatica
Pivoting wheel with anti-static
rubber tyre

Classica

Gamma colori

I carrelli Broggi possono essere prodotti, oltre che nel tradizionale color ebano, anche in alcuni colori speciali, come raffigurato nella tabella sottostante.

IMPORTANTE

Essendo il legno un prodotto naturale, i colori qui riprodotti sono indicativi. I nostri prodotti potrebbero essere soggetti a piccole variazioni di colore, lucentezza o intensità di venature che rientrano nella tolleranza. Eventuali differenze cromatiche rispetto ai campioni o a precedenti spedizioni non costituiscono quindi motivo di reclamo.

Colour range

In addition to the traditional ebony colour, Broggi trolleys can be also manufactured in some special colours, as shown in the table.

IMPORTANT

Being wood a natural product, the colours shown here are indicative only. Our products could have slight colour, brightness or intensity grain variations, within tolerance limits. Possible colour differences in comparison with samples or previous shipments are not reasons for claim.

Gamme de couleurs

Les tables roulantes Broggi peuvent être produits, en plus que dans la couleur ébène traditionnelle, aussi dans quelques couleurs spéciales, représentées dans le tableau.

IMPORTANT

Puisque le bois est un produit naturel, les couleurs reproduites ici sont indicatives. Nos produits pourraient être sujets à des petites variations dans la couleur, dans le brillant où dans l'intensité des veinures qui rentrent dans la tolérance. D'éventuelles différences chromatiques en ce qui concerne les échantillons où les livraisons précédentes ne constituent donc pas une raison de réclamation valable.

Gama de colores

Los carros Broggi pueden ser producidos, además de en el tradicional color ébano, en algunos colores especiales también, como ilustrado en la tabla.

IMPORTANTE

Siendo la madera un producto natural, los colores aquí reproducidos son indicativos. Nuestros productos podrían tener pequeñas variaciones de color, brillo o intensidad de veta en los límites de tolerancia. Eventuales diferencias cromáticas con las muestras o las expediciones anteriores no constituyen motivos de reclamación

Farben

Unsere Mehrzweckwagen werden nicht nur in Ebenholz sondern auch in Sonderfarben produziert (Tabelle).

WICHTIG

Die abgebildeten Farben sind unverbindlich; Holz ist ein Naturprodukt. Unregelmässigkeiten in Farbe und Masserung sind ein Zeichen dafür. Gebeizte Oberflächen können in Farbe und Glanzgrad von Farbmustern oder früheren Lieferungen abweichen. Dies ist kein Reklamationsgrund.



Cod. 51 **Mogano chiaro**

Light mahogany
Acajou clair
Caoba claro
Mahogani hell



Cod. 52 **Mogano**

Mahogany
Acajou
Caoba
Mahogani

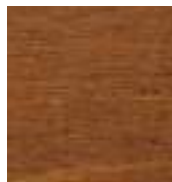

Cod. 54 **Noce scuro**

Dark walnut
Noyer foncé
Nogal oscuro
Nuss dunkel

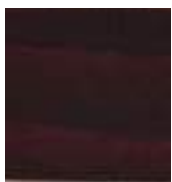

Cod. 55 **Palissandro**

Rosewood
Palissandre
Palisandro
Palisander

Manutenzione Wood

Wood Maintenance

MANUTENZIONE ARTICOLI IN LEGNO

Il legno è un materiale naturale e vivo, per questo è un'ottima materia prima per arredi, complementi e oggettistica.

Garantisce solidità, sicurezza e durata negli anni ma richiede anche interventi di manutenzione per conservare tutte le sue caratteristiche.

Esistono prodotti specifici per pulire e proteggere il legno nel rispetto della naturalezza di questo nobile materiale.

Come togliere i graffi dal legno:

In commercio esistono molti prodotti adatti per rimuovere i graffi dal legno come lucidanti pigmentati per mobili, applicabili con un panno pulito.

Per graffi particolarmente lievi o bordi sciupati è possibile usare dei markers per il ritocco che riescono a coprire graffi e segni di usura.

Per graffi più profondi è possibile usare una stecca di cera (del colore compatibile a quella del legno da riparare).

WOOD PRODUCTS MAINTENANCE

Wood is a natural and live material, consequently, it is an excellent raw material for furniture, accessories and objects.

It guarantees solidity, safety and durability over the years, however, it also requires maintenance in order to preserve all its characteristics.

There are specific products to clean and protect wood, respecting the naturalness of this noble material.

How to remove scratches from wood:

In the market there are many products suitable for removing scratches from wood like pigmented polishes, which can be applied with a clean cloth.

For light scratches or worn edges you can use touch-up markers, which can cover scratches and signs of wear.

For deep scratches you can use a wax stick (of colour compatible with the wood that needs repair).

Manutenzione PVD

PVD Maintenance

ISTRUZIONI D'USO E DI MANUTENZIONE PER LA POSATERIA ED IL VASSELLAME IN PVD

Lavare accuratamente i prodotti prima di utilizzarli per la prima volta. Dopo ogni utilizzo evitare di lasciare per tempi prolungati gli articoli sporchi a contatto con i residui alimentari e/o immersi nel liquido di rigoverno. Alcune sostanze contenute negli alimenti sono infatti dannose per il PVD e ne alterano l'aspetto. È quindi importante lavare gli articoli utilizzati subito dopo l'uso.

In caso di lavaggio manuale utilizzare acqua calda e sapone neutro, risciacquare con abbondante acqua tiepida ed asciugare scrupolosamente tutti gli articoli dopo il lavaggio per evitare la formazione di macchie dovute a depositi calcarei contenuti nell'acqua. Evitare tassativamente l'utilizzo di pomice, paglietta d'acciaio, spugnette o panni impregnati di polveri abrasive.

In caso di lavaggio in lavastoviglie utilizzare un programma a temperatura non superiore a 60°C. Tenere separati i coltelli dalle altre posate (forchette e cucchiari) e da altri articoli in acciaio inox. Escludere detersivi sintetici a base di cloro e con fosfati superiori al 10%, ossigeno o prodotti comunque candeggianti. È consigliabile estrarre ed asciugare accuratamente con un panno morbido tutti i pezzi subito dopo il lavaggio, anche se comprende un ciclo di asciugatura automatica. Non lasciare le posate e gli articoli in PVD nell'ambiente umido della lavastoviglie ma asciugarli e riporli in un ambiente asciutto.

Evitare di sottoporre i pezzi trattati in PVD a operazioni di pulizia o asciugatura utilizzando asciugatori o lucidatori automatici con azione di granuli, ceramici o paste/liquidi abrasivi. Possono essere invece utilizzati il tutolo di mais o detersivi non clorurati contenenti farina fossile.

Non utilizzare lavastoviglie a osmosi.

In caso di leggero viraggio del colore o macchie calcaree persistenti pulire con panno morbido e aceto e successivamente risciacquare con abbondante acqua tiepida e asciugare accuratamente.

PVD CUTLERY AND PLATE INSTRUCTION OF USE AND MAINTENANCE

Wash up carefully the PVD items before their first use.

Do not leave for a long time the dirty items in contact with alimentary residues and/or immersed all together in the washing water. Some substances contained in the aliments are in fact harmful for PVD and could alter its surface aspect. So it's very important to wash up all articles immediately after their use.

In case of hand wash use hot water and a good neutral detergent to wash them up; later on rinse out with abundant tepid water and meticulously dry all articles after the washing to avoid eventually forming of stains of limestone contained in the water. Pumice, steel wool, sponge or cloth saturated with abrasive powder have to be strictly excluded.

In case of wash with dishwasher use a washing program at temperature not higher than 60°C. Take knives separated from other cutlery (forks and spoons) and other stainless steel kitchenware. Do not use to wash any synthetic detergents at chlorine and with phosphates in % more than 10%, oxygen base or similar detergents bleaching. Remove and dry meticulously all cutlery after the washing with a soft cloth, even if the dishwasher has a cycle of automatic drying (this is to remove to surface of cutlery any limestone stains). Do not leave cutlery in the humidity of dishwasher but dry and put them in a dry room.

You could use cutlery dryer polisher machines with corncob powder. Do not use ceramics or similar and scrupulously avoid any abrasive liquid.

Do not use osmosis dishwasher machine.

In case of slight shading of color, or persistent limestone spots, clean with soft cloth and vinegar.

Manutenzione Alpacca e Acciaio Argentato

EPNS and EPSS Maintenance

ISTRUZIONI D'USO E DI MANUTENZIONE PER LA POSATERIA ED IL VASSELLAME IN ACCIAIO ARGENTATO E ALPACCA ARGENTATA

Lavare accuratamente i prodotti nuovi Utilizzare per il lavaggio acqua calda ed un buon sapone neutro, risciacquare in seguito con abbondante acqua tiepida ed asciugare scrupolosamente tutti gli articoli. Non utilizzare per il lavaggio detersivi sintetici a base di cloro o prodotti comunque candeggianti. Pomice, paglietta d'acciaio, spugnette o panni impregnati di polveri abrasive devono essere altresì rigorosamente esclusi. Possono invece essere utilizzati detersivi non clorurati contenente farina fossile. È consigliato il lavaggio degli articoli argentati subito dopo il loro utilizzo. Qualora questo non fosse possibile è comunque importante non lasciare per caso di utilizzo degli articoli a pranzo articoli a cena, andrebbero lavati entro la mattina del giorno seguente). Nel caso fosse necessario un prelavaggio, questo deve essere fatto relativamente breve. Gli articoli non vanno infatti lasciati in ammollo quanto alcune sostanze contenute negli alimenti sono dannose per l'argentatura galvanica e ne alterano l'aspetto. Le lame dei coltelli prodotte con un pregiato acciaio inossidabile, sono sensibili agli attacchi corrosivi sviluppati dall'acido acetico, citrico, lattico ed in particolare da cloruro di sodio, presenti negli alimenti.

È importante, sia in fase di prelavaggio che durante il lavaggio, tenere separate le normali posate (cucchiai, forchette, cucchiaini...) dai coltelli e da altri oggetti metallici presenti in cucina.

Nel caso di lavaggio in lavastoviglie le posate devono essere inserite in cestelli verticali di plastica e tenute separate dai coltelli.

Asciugare accuratamente gli articoli con un panno morbido subito dopo il lavaggio, anche se il lavaggio è eseguito in lavastoviglie che prevede un ciclo di asciugatura automatica. Questo è necessario per evitare l'eventuale formazione di macchie dovute a depositi calcarei contenuti nell'acqua.

Non lasciare le posate nell'ambiente umido della lavastoviglie una volta terminato il ciclo di lavaggio, ma asciugarle e riporle in un ambiente asciutto.

Per lo stoccaggio degli articoli argentati si consiglia l'utilizzo di casse in plastica con coperchio che evitano il passaggio di aria e luce che faciliterebbero l'ossidazione dell'argento. È molto importante riporre gli articoli nella cassa perfettamente asciutti. Per evitare rigature si consiglia di non inserire alla rinfusa gli articoli ma di riporli ordinatamente e proteggere i vari strati con un panno morbido. Questo sistema di stoccaggio evita il rilavaggio degli articoli prima del loro utilizzo.

L'argento per sua natura è portato a solforarsi in presenza dell'aria e della luce, assumendo prima o poi una colorazione scura più o meno uniforme. Ciò avviene anche per il contatto con alcune sostanze presenti negli alimenti (limone, aceto, maionese o salse, tuorlo d'uovo...) ed in tal caso si può notare la formazione di macchie. Si tratta comunque di un fenomeno naturale che non danneggia il rivestimento d'argento degli articoli ma che ne altera l'aspetto. Per ridare all'argenteria il suo originale splendore sono disponibili in commercio alcuni prodotti antiossidanti specifici per la pulizia dell'argento e appositamente preparati da case qualificate. Si sconsiglia l'uso frequente della Burnishing Machine. Utilizzare al massimo 2/3 volte l'anno e con sfere di acciaio inox AISI 304 (per evitare magnetizzazioni dell'argento), di piccolo diametro (Ø max 3 mm). Successivamente gli articoli devono essere lucidati utilizzando tutolo di mais.

Un utilizzo più frequente della Burnishing Machine e l'utilizzo di sfere non idonee provoca inevitabilmente danni al prodotto con conseguente asportazione dell'argento dagli articoli e la corrosione dello stesso nella parte argentata magnetizzata.

INSTRUCTION OF USE AND MAINTENANCE OF SILVER PLATED STAINLESS STEEL AND ELECTRO-PLATED NICKEL SILVER CUTLERY AND HOLLOWWARE

Wash the new products carefully before use. Use hot water to wash them and a good neutral detergent; then, rinse out with tepid water and dry all the items thoroughly. When washing, do not use chlorinated detergents nor products containing bleach. Pumice, steel wool, sponges or cloths saturated with abrasive powders must be strictly avoided. However, detergents without chloride containing fossil flour can be used. The washing of plated items after use is recommended. In case that would not be possible, it is however important not to leave for more than 12 hours the dirty items in contact with food leftovers (e.g.: if the items are used at lunch, they should be washed within the evening; if the items are used at dinner, they should be washed within the following morning). In case a prewash was needed, it must be carried out just before the washing and for a relatively short time. In fact, the items must not be soaked in the washing solution for too long, since some substances contained in food are damaging for the electroplating and change its appearance. Knives blades are manufactured with a valuable stainless steel and are sensitive to the corrosion attacks developed by acetic, citric and lactic acid and in particular to sodium chloride present in food.

In case of washing in dishwasher, spoons and forks must be placed into plastic vertical baskets and kept separated from knives.

Dry the items thoroughly immediately after the washing with a soft cloth, even if your dishwasher has a dry cycle. That is necessary in order to avoid the possible formation of stains caused by calcareous deposits contained in the water.

Do not leave the cutlery in the humid environment of the dishwasher once the washing finishes; dry them and store them in a dry place.

For the storage of the silver plated items it is recommended the use of plastic box es with cover, in order to avoid air and light that could facilitate the oxidation of silver. It is very important that the items are replaced in the box perfectly dry. In order to avoid scratches, it is recommended not to place the items in the box randomly, but to place them in an orderly way and protect the various layers with a soft cloth. This storage method avoids the rewashing of the items before they are used.

Silver by its nature tends to tarnish with air and light, getting unevenly darker sooner or later. This is due to the contact with some substances contained in food (lemon, vinegar, mayonnaise or sauces, egg yolk...) and in this case you can notice the formation of stains. However, this is a natural event that does not damage the silver coating of the items but simply changes their appearance. In order to restore its original splendor to silverware, there are available in the market some antioxidant products for silver cleaning and specially prepared by qualified companies.

The frequent use of the Burnishing Machine is not recommended. You can use it twice or three times a year maximum, with AISI 304 stainless steel spheres (to avoid silver magnetization), small diameter (Ø max 3 mm). After that, the items must be polished using corn powder.

A more frequent use of the Burnishing Machine and the use of non suitable spheres inevitably causes damages to the products with the consequent removal of the silver coating from the items and the corrosion of the same in the magnetized silvered part.

Manutenzione Acciaio

St. Steel Maintenance

ISTRUZIONI D'USO E DI MANUTENZIONE PER LA POSATERIA ED IL VASELLAME IN ACCIAIO

Lavare accuratamente i prodotti nuovi Utilizzare per il lavaggio acqua calda ed un buon sapone neutro, risciacquare in seguito con abbondante acqua tiepida ed asciugare scrupolosamente tutti gli articoli. Non utilizzare per il lavaggio detersivi sintetici a base di cloro o prodotti comunque candeggianti. Pomice, paglietta d'acciaio, spugnette o panni impregnati di polveri abrasive devono essere altresì rigorosamente esclusi. Possono invece essere utilizzati detersivi non clorurati contenente farina fossile. È consigliato il lavaggio degli articoli subito dopo il loro utilizzo. Qualora questo non fosse possibile è comunque importante non lasciare per caso di utilizzo degli articoli a pranzo articoli a cena, andrebbero lavati entro la mattina del giorno seguente). Nel caso fosse necessario un prelavaggio, questo deve essere fatto relativamente breve. Gli articoli non vanno infatti lasciati in ammollo quanto alcune sostanze contenute negli alimenti sono dannose e ne alterano l'aspetto. Le lame dei coltelli prodotte con un pregiato acciaio inossidabile, sono sensibili agli attacchi corrosivi sviluppati dall'acido acetico, citrico, lattico ed in particolare da cloruro di sodio, presenti negli alimenti.

È importante, sia in fase di prelavaggio che durante il lavaggio, tenere separate le normali posate (cucchiai, forchette, cucchiaini...) dai coltelli e da altri oggetti metallici presenti in cucina.

Nel caso di lavaggio in lavastoviglie le posate devono essere inserite in cestelli verticali di plastica e tenute separate dai coltelli.

Asciugare accuratamente gli articoli con un panno morbido subito dopo il lavaggio, anche se il lavaggio è eseguito in lavastoviglie che prevede un ciclo di asciugatura automatica. Questo è necessario per evitare l'eventuale formazione di macchie dovute a depositi calcarei contenuti nell'acqua.

Non lasciare le posate nell'ambiente umido della lavastoviglie una volta terminato il ciclo di lavaggio, ma asciugarle e riporle in un ambiente asciutto.

INSTRUCTION OF USE AND MAINTENANCE OF STAINLESS STEEL CUTLERY AND HOLLOWWARE

Wash the new products carefully before use. Use hot water to wash them and a good neutral detergent; then, rinse out with tepid water and dry all the items thoroughly. When washing, do not use chlorinated detergents nor products containing bleach. Pumice, steel wool, sponges or cloths saturated with abrasive powders must be strictly avoided. However, detergents without chloride containing fossil flour can be used. The washing of items after use is recommended. In case that would not be possible, it is however important not to leave for more than 12 hours the dirty items in contact with food leftovers (e.g.: if the items are used at lunch, they should be washed within the evening; if the items are used at dinner, they should be washed within the following morning). In case a prewash was needed, it must be carried out just before the washing and for a relatively short time. In fact, the items must not be soaked in the washing solution for too long, since some substances contained in food are damaging for the electroplating and change its appearance. Knives blades are manufactured with a valuable stainless steel and are sensitive to the corrosion attacks developed by acetic, citric and lactic acid and in particular to sodium chloride present in food.

In case of washing in dishwasher, spoons and forks must be placed into plastic vertical baskets and kept separated from knives.

Dry the items thoroughly immediately after the washing with a soft cloth, even if your dishwasher has a dry cycle. That is necessary in order to avoid the possible formation of stains caused by calcareous deposits contained in the water.

Do not leave the cutlery in the humid environment of the dishwasher once the washing finishes; dry them and store them in a dry place.





