



Broggi 1818

Buffet 2024





Decò



Cubo Decò

Decò cube
Cube Decò
Cubo Decò
Decò Würfel

ACCIAIO - St. steel

	base Cm	H Cm	base in.	H in.
326 05 42 001	15 x 15	15,0	5,9 x 5,9	5,9
326 05 42 002	20 x 20	20,0	7,9 x 7,9	7,9
326 05 42 003	25 x 25	25,0	9,8 x 9,8	9,8

ACCIAIO DORATO - Gilded st. steel

	base Cm	H Cm	base in.	H in.
326 28 42 001	15 x 15	15,0	5,9 x 5,9	5,9
326 28 42 002	20 x 20	20,0	7,9 x 7,9	7,9
326 28 42 003	25 x 25	25,0	9,8 x 9,8	9,8

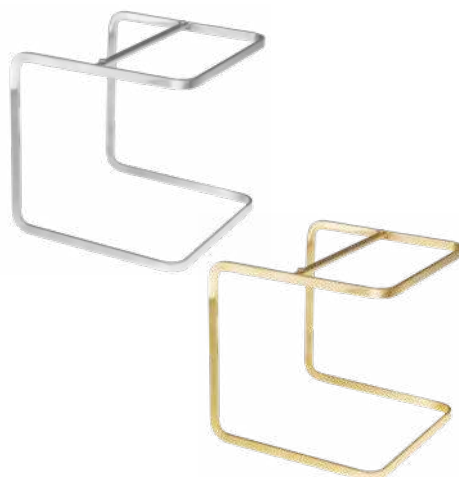

Piano Decò, quadrato

Decò top, square
Dessus Decò carré
Tablero Decò cuadrado
Platte Decò quadrat

MARMO DI CARRARA - Carrara marble

	base Cm	H Cm	base in.	H in.
326 22 42 001	15 x 15	1,2	5,9 x 5,9	0,5
326 22 42 002	20 x 20	1,2	7,9 x 7,9	0,5
326 22 42 003	25 x 25	1,2	9,8 x 9,8	0,5

HPL

	base Cm	H Cm	base in.	H In
326 64 42 001	15 x 15	1,2	5,9 x 5,9	0,5
326 64 42 002	20 x 20	1,2	7,9 x 7,9	0,5
326 64 42 003	25 x 25	1,2	9,8 x 9,8	0,5

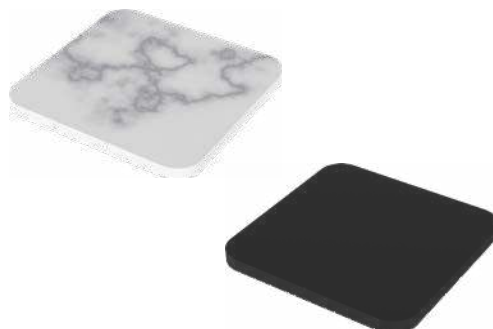

Piano Decò, rettangolare

Decò top, rectangular
Dessus Decò rectangulaire
Tablero Decò rectangular
Platte Decò rechteckig

MARMO DI CARRARA - Carrara marble

	base Cm	H Cm	base in.	H In
326 22 42 004	15 x 50	1,2	5,9 x 19,7	0,5
326 22 42 005	20 x 60	1,2	7,9 x 23,6	0,5
326 22 42 006	25 x 70	1,2	9,8 x 27,6	0,5

HPL

	base Cm	H Cm	base in.	H In
326 64 42 004	15 x 50	1,2	5,9 x 19,7	0,5
326 64 42 005	20 x 60	1,2	7,9 x 23,6	0,5
326 64 42 006	25 x 70	1,2	9,8 x 27,6	0,5



Cilindro Decò

Decò cylinder
Cylindre Decò
Cilindro Decò
Decò Zylinder

ACCIAIO - St. steel

	base Ø Cm	H Cm	base Ø in.	H in
326 05 42 004	20	15	7,9	5,9
326 05 42 005	20	25	7,9	9,8

ACCIAIO DORATO - Gilded st. steel

	base Ø Cm	H Cm	base Ø in.	H in
326 28 42 004	20	15	7,9	5,9
326 28 42 005	20	25	7,9	9,8

**Piano Decò, tondo**

Decò top, square
Dessus Decò ronde
Tablero Decò redondo
Platte Decò runden

MARMO DI CARRARA - Carrara marble

	base Ø Cm	H Cm	base in.	H In
326 22 42 007	15	1,2	5,9	0,5
326 22 42 008	19	1,2	7 1/2	0,5
326 22 42 009	20	1,2	7,9	0,5

HPL

	base Ø Cm	H Cm	base in.	H In
326 64 42 007	15	1,2	5,9	0,5
326 64 42 008	19	1,2	7 1/2	0,5
326 64 42 009	20	1,2	7,9	0,5

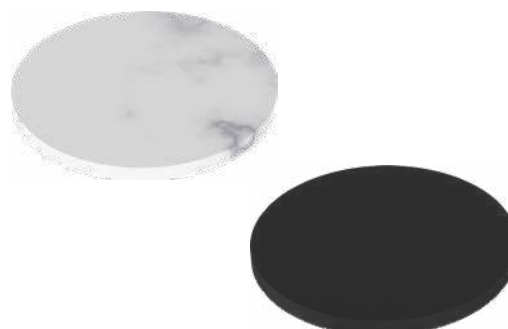
**Cestino pane Decò su alzata tonda**

Decò bread basket on round standl
Corbeille à pain Decò sur support rond
Cesta pan Decò sobre soporte redondo
Brotkorb Decò, rund

ACCIAIO - St. steel

	Ø Cm	H Cm	In	H In
326 05 24 010	20	15	7,9	5,9
326 05 24 011	20	25	7,9	9,8

ACCIAIO DORATO - Gilded st. steel

	Ø Cm	H Cm	In	H In
326 28 24 010	20	15	7,9	5,9
326 28 24 011	20	25	7,9	9,8





Distributore vetro doppio corpo

Dispenser, glass, double-wall

*Distributeur verre double parois**Dispensador cristal doble pared**Spender, Glas, doppelwandig***ACCIAIO/MARMO - chromed/Marble**

	Lt	Oz
326 05 52 003	2,5	84,5

ACCIAIO/HPL - chromed/HPL

	Lt	Oz
326 05 52 004	2,5	84,5

**Distributore vetro doppio corpo**

Dispenser, glass, double-wall

*Distributeur verre double parois**Dispensador cristal doble pared**Spender, Glas, doppelwandig***DORATO/MARMO - gilded/Marble**

	Lt	Oz
326 28 52 003	2,5	84,5

DORATO/HPL - gilded/HPL

	Lt	Oz
326 28 52 004	2,5	84,5





Distributore succhi Decò

Decò juice dispenser
 Distributeur de jus Decò
 Dispensador zumo Decò
 Müslispender Decò;

ACCIAIO/MARMO - steel/Marble

	Lt	Oz
326 05 52 005	8	270,5

ACCIAIO/HPL - steel/HPL

	Lt	Oz
326 05 52 006	8	270,5

**Distributore succhi Decò**

Decò juice dispenser
 Distributeur de jus Decò
 Dispensador zumo Decò
 Müslispender Decò;

ACCIAIO/MARMO - chromed/Marble

	Lt	Oz
326 28 52 005	8	270,5

ACCIAIO DORATO/HPL - gilded steel/HPL

	Lt	Oz
326 28 52 006	8	270,5



Distributore cereali Decò

Decò cereal dispenser
Distributeur céréales Decò
Dispensador cereales Decò
Müslispender Decò

ACCIAIO/MARMO - chromed/Marble

	Lt	Oz
326 05 52 001	3	101

ACCIAIO/HPL - chromed/HPL

	Lt	Oz
326 05 52 002	3	101



Distributore cereali Decò

Decò cereal dispenser
Distributeur céréales Decò
Dispensador cereales Decò
Müslispender Decò

DORATO/MARMO - gilded/Marble

	Lt	Oz
326 28 52 001	3	101

DORATO/HPL - gilded/HPL

	Lt	Oz
326 28 52 002	3	101



Distributore caffè Decò

Decò coffee urn
 Distributeur de café
 Dispensador café
 Kaffeespender Decò

ACCIAIO/MARMO - chromed/Marble

	Lt	Oz
326 05 52 007	7	236,7
326 05 52 009	10	338,1

ACCIAIO/HPL - chromed/HPL

	Lt	Oz
326 05 52 008	7	236,7
326 05 52 010	10	338,1

**Distributore caffè Decò**

Decò coffee urn
 Distributeur de café
 Dispensador café
 Kaffeespender Decò

DORATO/MARMO - gilded/Marble

	Lt	Oz
326 28 52 007	7	236,7
326 28 52 009	10	338,1

DORATO/HPL - gilded/HPL

	Lt	Oz
326 28 52 008	7	236,7
326 28 52 010	10	338,1

**Piastra elettrica scalda-caffè**

Coffee-warmer electric plate
 Plaque chauffante électrique à café
 Placa eléctrica calientacafé
 Kaffeewärmer mit elektrischer Platte

305 05 52 576







Vassoio ringhiera Decò in filo di acciaio

Decò tray with railing steel wire
 Plateau Decò avec rambarde en acier
 Bandeja Decò con barandilla en acero
 Platte Decò mit Edelstahlreling

FILO DI ACCIAIO - Railing steel wire

	Cm	H Cm	In	H In
326 05 23 010	40 x 40	7	15,3/4 x 15,3/4	2,3/4
326 05 23 011	60 x 40	7	23,5/8 x 15,3/4	2,3/4

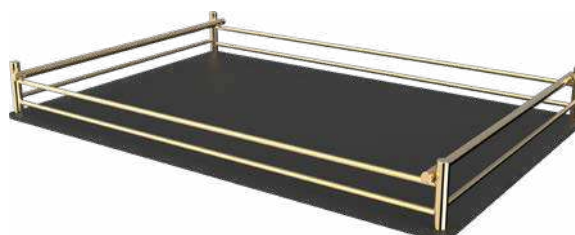
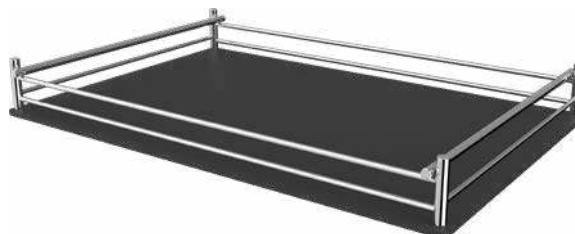

FILO DI ACCIAIO DORATO - Railing gilded steel wire

	Cm	H Cm	In	H In
326 28 23 010	40 x 40	7	15,3/4 x 15,3/4	2,3/4
326 28 23 011	60 x 40	7	23,5/8 x 15,3/4	2,3/4

FILO DI ACCIAIO CON PANNINO - Steel wire railing and fabric

	Cm	H Cm	In	H In
326 05 23 012	60 x 40	7	23,5/8 x 15,3/4	2,3/4



FILO DI ACCIAIO DORATO CON PANNINO

Gilded steel wire railing and fabric

	Cm	H Cm	In	H In
326 28 23 012	60 x 40	7	23,5/8 x 15,3/4	2,3/4





Portacaraffe Decò refrigerato

Decò jug stand, refrigerated
 Support pour carafes Decò réfrigéré
 Soporte para jarras Decò refrigerado
 Flaschenhalter Decò, gekühlt

ACCIAIO - St.steel

	Cm	H Cm	In	H In
326 05 24 001	52,5 x 20	9	20,5/8 x 7,7/8	3,1/2

ACCIAIO DORATO - Gilded st.steel

	Cm	H Cm	In	H In
326 28 24 001	52,5 x 20	9	20,5/8 x 7,7/8	3,1/2



Barella Decò

Tray
 Plateau
 Bandeja
 Tablett

CON PIANO IN HPL - HPL top

	Cm	H Cm	In	H In
326 05 23 001	52,5 x 20	5	20,5/8 x 7,7/8	2

CON PIANO IN HPL DORATO - HPL top, gilded

	Cm	H Cm	In	H In
326 28 23 001	52,5 x 20	5	20,5/8 x 7,7/8	2



Supporto alto per ciotole

bowl stand, high
Support pour bols haut
Soporte para boles alto
Schüsselständer, hoch

ACCIAIO - St.steel

	Cm	H Cm	In	H In
326 05 42 011	52,5 x 20	20	20,5/8 x 7,7/8	7,7/8

ACCIAIO DORATO - Gilded st.steel

	Cm	H Cm	In	H In
326 28 42 011	52,5 x 20	20	20,5/8 x 7,7/8	7,7/8

Ciotole artesano o ciotole urban non incluse
 Artesano bowls or urban bowls not included

**Supporto alto per vasi**

Jar stand, hig
Support pour pots en verre haut
Soporte para jarrones de cristal alto
Glasständer, hoch

ACCIAIO - St.steel

	Cm	H Cm	In	H In
326 05 42 010	52,5 x 20	20	20,5/8 x 7,7/8	7,7/8

ACCIAIO DORATO - Gilded st.steel

	Cm	H Cm	In	H In
326 28 42 010	52,5 x 20	20	20,5/8 x 7,7/8	7,7/8

Vasi in vetro non incluso / Glass jars with lid not included

**Supporto medio per ciotole**

bowl stand, medium
Support pour bols moyen
Soporte para boles mediano
Schüsselständer, mittel

ACCIAIO - St.steel

	Cm	H Cm	In	H In
326 05 42 013	52,5 x 20	13,5	20,5/8 x 7,7/8	5,3/8

ACCIAIO DORATO - Gilded st.steel

	Cm	H Cm	In	H In
326 28 42 013	52,5 x 20	13,5	20,5/8 x 7,7/8	5,3/8

Ciotole artesano o ciotole urban non incluse
 Artesano bowls or urban bowls not included

**Supporto medio per vasi**

Jar stand, medium
Support pour pots en verre moyen
Soporte para jarrones de cristal mediano
Glasständer, mittel

ACCIAIO - St.steel

	Cm	H Cm	In	H In
326 05 42 012	52,5 x 20	13,5	20,5/8 x 7,7/8	5,3/8

ACCIAIO DORATO - Gilded st.steel

	Cm	H Cm	In	H In
326 28 42 012	52,5 x 20	13,5	20,5/8 x 7,7/8	5,3/8

Vasi in vetro non incluso / Glass jars with lid not included







Alzata scaffale Decò 2 piani

Decò 2-shelf stand

Etagère Decò 2 étages

Estante Decò 2 estantes Regalständer

Decò mit 2 Böden

ACCIAIO/HPL - Chromed/hpl

	Cm	H Cm	In	H In
326 05 42 020	15 x 50	25,5	6 x 19,7/8	10
326 05 42 021	20 x 60	25,5	7,7/8 x 23 5/8	10



ACCIAIO/MARMO - Chromed/marble

	Cm	H Cm	In	H In
326 05 42 022	15 x 50	25,5	6 x 19,7/8	10
326 05 42 023	20 x 60	25,5	7,7/8 x 23 5/8	10



DORATO/HPL - Gilded/hpl

	Cm	H Cm	In	H In
326 28 42 020	15 x 50	25,5	6 x 19,7/8	10
326 28 42 021	20 x 60	25,5	7,7/8 x 23 5/8	10



DORATO/MARMO - gilded/marble

	Cm	H Cm	In	H In
326 28 42 022	15 x 50	25,5	6 x 19,7/8	10
326 28 42 023	20 x 60	25,5	7,7/8 x 23 5/8	10



Portaformaggi refrigerato Decò con bascula

Decò cheese dish, thermal with roll-top cover
 Plateau à fromage réfrigéré Decò avec bascule
 Porta queso refrigerado Decò con bascula
 Käseplatte Decò, gekühlt mit Rolltop-Cover,

ACCIAIO - St.steel

	Cm	In
326 05 54 002	52 x 32	20,1/2 x 12,5/8

ACCIAIO DORATO - Gilded st.steel

	Cm	In
326 28 54 002	52 x 32	20,1/2 x 12,5/8



Vassoio formaggi refrigerato Decò

Decò cheese tray, thermal
 Plateau à fromage réfrigéré Decò
 Bandeja queso refrigerado Decò
 Käseplatte Decò, gekühlt

ACCIAIO - St.steel

	Cm	In
326 05 54 001	52 x 32	20,1/2 x 12,5/8

ACCIAIO DORATO - Gilded st.steel

	Cm	In
326 28 54 001	52 x 32	20,1/2 x 12,5/8





Nature Buffet



Nature

Alzata torta in noce bassa

Cake stand, walnut

Présentoir à gâteau x en bois de noyer

Presentación tarta en madera de nogal

Tortenplatte Walnussholz

Noce - Walnut

	Ø Cm	Ø In	H Cm	H In
305 54 42 673 (small)	28	11	14	5,5
305 54 42 674 (medium)	33	12,9	14	5,5
305 54 42 675 (large)	37	14,5	14	5,5



Alzata torta in noce alta

Cake stand, walnut

Présentoir à gâteau x en bois de noyer

Presentación tarta en madera de nogal

Tortenplatte Walnussholz

Noce - Walnut

	Ø Cm	Ø In	H Cm	H In
305 54 42 676 (small)	28	11	21	8,2
305 54 42 677 (medium)	33	12,9	21	8,2
305 54 42 678 (large)	37	14,5	21	8,2



**Coperchio a bascula
adatto per alzate Ø37Cm
suitable for stands Ø37Cm**

Transparent round rolltop cover
Cloche basculante ronde transparente
Rolltophaube - rund
Campana redonda transparente

SAN

	Ø Cm	Ø In
V76 12 15 T01	34	13,3/8



**Cupola in vetro
adatto per alzate Ø28Cm
suitable for stands Ø28Cm**

Dome cover, glass
Cloche en verre
Campana de vidrio
Cloche aus Glas

Vetro - Glass

	Ø Cm	Ø In
404 10 42 610	25	9,8



**Cupola in policarbonato
adatto per alzate Ø28Cm
suitable for stands Ø28Cm**

Dome cover, acrylic
Cloche en acrylique
Campana de acrilico
Cloche aus Polycarbonat

Polycarbonato - Polycarbonat

	Ø Cm	Ø In
305 12 53 625	26	10,2



Nature

Alzata pasticceria Noce

Cake stand, walnut

Présentoir à gâteau x en bois de noyer

Soporte pasteles en madera de nogal

Tortenplatte Walnussholz

Noce - Walnut

	Ø Cm	H Cm	Ø In	H In
305 54 42 692	16	9 Cm	6,1/4	3,1/2



Alzata pasticceria 2 piani

Petit fours stand

Plat à petits fours sur pied

Petit Four Stand

Soporte pasteles

Noce - Walnut

	H Cm	H In
305 54 42 671 (2 posti)	23,5 x 24,4	12



Alzata pasticceria 3 piani

Petit fours stand

Plat à petits fours sur pied

Petit Four Stand

Soporte pasteles

Noce - Walnut

	H Cm	H In
305 54 42 670 (3 posti)	43 x 41,5	12



Piattino rettangolare

Rectangular plate - Plato rectangular

Plat rectangulaire - Rechteckige Teeller

Porcellana - Porcelain

	Cm	In
264 00 42 669	18 x 11	7 x 4,3



Ciotolina a goccia

Bowl - Bol

Bol - Schüssel

Porcellana - Porcelain

V87 21 42 001

Cm	In
8 x 7 x 4	3,1 x 1,5



Piattino quadrato porcellana

Square saucer - Platillo cuadrado

Soucoupe carrée - Quadratische teller

Porcellana - Porcelain

	Cm	In
322 21 22 691	10 x 10	3,9 x 3,9



Coppetta rotonda

Round bowl - Bol redondo

Bol rond - Runde Schüssel

Porcellana - Porcelain

	Ø Cm	Ø In
V87 21 42 005	7	2,7





Distributore Aqva con alzata Nature

Aqva dispenser with Nature stand

Distributeur Aqva avec support Nature

Dispensador Aqva con soporte Nature

Aqua Getränkespender mit Ständer Nature

	Cm	In	H Cm	H In
305 44 52 711	26 x 26	38	10,1/4 x 10,1/4	31,1/2
nero/black				

305 05 52 711	26 x 26	38	10,1/4 x 10,1/4	31,1/2
cromato/chromed				

Distributore Aqva con base in noce

Aqva dispenser with walnut wood stand

Distributeur Aqva avec support en bois de noyer

Dispensador Aqva con soporte en madera de nogal

Getränkespender Aqva mit Ständer aus Walnussholz

Noce e vetro - Walnut and glass

	H Cm	H In
305 54 52 728	63	24.8







Nature



Piano in noce massello

Solid walnut wood top

Dessus en bois massif noyer

Tabla de madera maciza de nogal

Top Walnuss massiv

	Cm	In
305 54 42 629	30 x 30	11,3/4 x 11,3/4
305 54 42 630	70 x 30	27,1/2 x 11,3/4
305 54 42 631	100 x 30	39,3/8 x 11,3/4



Piano in ardesia

Slate top

Dessus en ardoise

Tabla de pizarra

Top Schiefer

	Cm	In
V87 09 42 Q01	30 x 30	11,3/4 x 11,3/4
V87 09 42 R01	70 x 30	27,1/2 x 11,3/4
V87 09 42 R02	100 x 30	39,3/8 x 11,3/4



Piano in pietra lavica

Lava top

Dessus en pierre de lave

Tabla de piedra lávica

Top Lavastein

	Cm	In
305 60 42 633	30 x 30	11,3/4 x 11,3/4
305 60 42 634	70 x 30	27,1/2 x 11,3/4
305 60 42 635	100 x 30	39,3/8 x 11,3/4



Vassoio per alzate rettangolare

Tray for podia, rectangular
 Plateau pour supports rectangulaire
 Bandeja rectangular para soportes
 Tablett Walnuss, rechteckig

Noce - Walnut

	Cm	H Cm	In	H In
305 54 23 854	35 x 52,5	4,5	13,3/4 x 20,5/8	1,3/4

**Vassoio per alzate rettangolare**

Tray for podia, rectangular
 Plateau pour supports rectangulaire
 Bandeja rectangular para soportes
 Tablett Walnuss, rechteckig

Noce - Walnut

	Cm	H Cm	In	H In
305 54 23 855	35 x 52,5	8	13,3/4 x 20,5/8	3,1/8

**Vassoio per alzate rettangolare**

Tray for podia, rectangular
 Plateau pour supports rectangulaire
 Bandeja rectangular para soportes
 Tablett Walnuss, rechteckig

Noce - Walnut

	Cm	H Cm	In	H In
305 54 23 853	17,5 x 52,5	4,5	6,7/8 x 20,5/8	1,3/4

**Vassoio alzata Nature in legno**

Nature tray, walnut wood
 Plateau Nature en bois noyer
 Bandeja Nature en madera de nogal
 Tablett Walnuss rechteckig

	Cm	H Cm	In	H In
305 54 23 886	26 x 35	4,5	10,2 x 13,8	1,3/4

**Base inclinata per vassoi**

Inclined base for rectangular trays
 Base inclinée pour plateau x rectangulair
 Base inclinada para bandejas
 Basistablett mit Kante rechteckig

Noce - Walnut

	Cm	H Cm	In	H In
305 54 23 856	35 x 52,5	6,7	13,3/4 x 20,5/8	2,1/2



Nature

Alzata quadrata nera opaca

Square podium

Support carré

Soporte cuadrado

Podest quadratisch

NERA OPACA - matte black

	Cm	H Cm	In	H In
305 44 42 621	18 x 18	20	7 x 7	7,7/8
305 44 42 622	18 x 18	25	7 x 7	9,7/8
305 44 42 623	18 x 18	30	7 x 7	11,3/4

CROMATA - cromed

	Cm	H Cm	In	H In
305 05 42 621	18 x 18	20	7 x 7	7,7/8
305 05 42 622	18 x 18	25	7 x 7	9,7/8
305 05 42 623	18 x 18	30	7 x 7	11,3/4



Alzata rettangolare

Rectangular podium

Support rectangulaire

Soporte rectangular

Podest rechteckig

NERA OPACA - matte black

	Cm	H Cm	In	H In
305 44 42 625	17,5 x 52,5	13,5	6,7/8 x 20,5/8	5,3/4
305 44 42 626	17,5 x 52,5	20	6,7/8 x 20,5/8	7,7/8

CROMATA - cromed

	Cm	H Cm	In	H In
305 05 42 625	17,5 x 52,5	13,5	6,7/8 x 20,5/8	5,3/4
305 05 42 626	17,5 x 52,5	20	6,7/8 x 20,5/8	7,7/8



Alzata rettangolare

Rectangular podium

Support rectangulaire

Soporte rectangular

Podest rechteckig

NERA OPACA - matte black

	Cm	H Cm	In	H In
305 44 42 627	35 x 52,5	13,5	13,3/4 x 20,5/8	5,3/4
305 44 42 628	35 x 52,5	20	13,3/4 x 20,5/8	7,7/8

CROMATA - cromed

	Cm	H Cm	In	H In
305 05 42 627	35 x 52,5	13,5	13,3/4 x 20,5/8	5,3/4
305 05 42 628	35 x 52,5	20	13,3/4 x 20,5/8	7,7/8

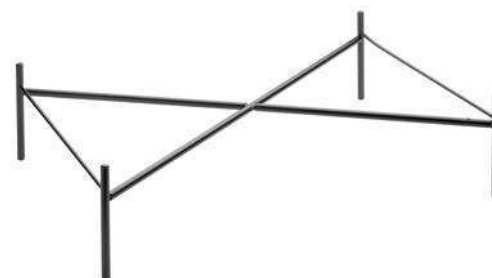

Alzata rettangolare per porcellane

Rectangular podium for porcelain items

Support rectangulaire pour articles en porcelaine

Soporte rectangular para artículos de porcelana

Podest rechteckig für Artikel aus Porzellan

NERA OPACA - matte black

	Cm	H Cm	In	H
305 44 42 624	12 x 40	13,5	4,3/4 x 15,3/4	5,3/4
305 44 42 632	12 x 40	20	4,3/4 x 15,3/4	7,7/8

CROMATA - cromed

	Cm	H Cm	In	H
305 05 42 624	12 x 40	13,5	4,3/4 x 15,3/4	5,3/4
305 05 42 632	12 x 40	20	4,3/4 x 15,3/4	7,7/8





Cestino pane per alzata quadrata

Bread basket for square podium

Corbeille à pain pour support carré

Cesta para pan para soporte cuadrado

Brotkorb für Podium quadratisch

Misto lino - Linen blend

	Cm	H Cm	In	H In
305 29 24 588	18 x 18	20	7 x 7	7,7/8



Alzata quadrata nera opaca

Matte black square podium

Support carré noir

Soporte cuadrado negro mate

Podest quadratisch Schwarz

	Cm	H Cm	In	H In
305 44 42 621	18 x 18	20	7 x 7	7,7/8
305 44 42 622	18 x 18	25	7 x 7	9,7/8
305 44 42 623	18 x 18	30	7 x 7	11,3/4



Cestino pane per alzata rettangolare

Bread basket for rectangular podium

Corbeille à pain pour support rectangulaire

Cesta para pan para soporte rectangular

Brotkorb für Podium rechteckig Cm

Misto lino - Linen blend

	Cm	H Cm	In	H In
305 29 24 589	17,5 x 52,5	13,5	6,7/8 x 20,5/8	5,3/4
305 29 24 590	17,5 x 52,5	20	6,7/8 x 20,5/8	7,7/8



Alzata rettangolare nera opaca

Matt black rectangular podium

Support rectangulaire noir

Soporte rectangular negro mate

Podest rechteckig Schwarz

	Cm	H Cm	In	H In
305 44 42 625	17,5 x 52,5	13,5	6,7/8 x 20,5/8	5,3/4
305 44 42 626	17,5 x 52,5	20	6,7/8 x 20,5/8	7,7/8



Nature



Base legno per 3 ciotole in porcellana

Wood base fitting 3 porcelain bowls
 Base en bois pour 3 bols en porcelaine
 Base de madera para 3 boles de porcelana
 Holzbasis für 3 Porzellan Bols

Noce - Walnut

	Cm	H Cm	In	H In
305 54 54 608	17,5 x 52,5	2,5	6,7/8 x 20,5/8	1



Ciotola Artesano

Artesano bowl
 Bol Artesano
 Bol Artesano
 Artesano bol

Porcellana - Porcelain

	Lt	Oz
264 02 51 900	0,6	21



Ciotola Urban

Urban bowl
 Bol Urban
 Bol Urban
 Urban bol

Porcellana - Porcelain

	Lt	Oz
263 45 21 900	0,6	21



Base in legno con 3 fori

Wood base with 3 holes

Base en bois avec 3 trous

Base de madera con 3 agujeros

Holzbasis mit 3 runden Ausschnitten

Noce - Walnut

	Cm	H Cm	In	H In
305 54 54 609	17,5 x 52,5	2,5	6,7/8 x 20,5/8	1

**Vaso in vetro con coperchio**

Glass jar with lid

Pot en verre avec couvercle

Jarrón de vidrio con tapa

Glasdose mit Deckel

Vetro - Glass

	Ø Cm	H Cm	In	H In
404 10 31 304	14	17,5	5,1/2	6,7/8
404 10 31 305	14	23	5,1/2	9
404 10 31 306	14	29,5	5,1/2	11,5/8

**Coppetta affinity**

Affinity bowl

Bol Affinity

Bol Affinity

Affinity Bol

Porcellana - Porcelain

	Ø Cm	Ø In
264 00 43 800	15	6

**Coperchio per coppetta in vetro**

Lid for glass bowl

Couvercle pour bol en verre

Tapa para bol de vidrio

Deckel für Glasschale

Inox 18/10 - St. Steel

	Ø Cm	Ø In
B01 12 52 640	15	6

**Coppetta in vetro**

Glass bowl

Bol en verre

Bol de vidrio

Glasschale

Vetro - Glass

	Ø Cm	Ø In
V76 08 52 004	15	6







Nature

Piatto ovale Artesano

Artesano oval bowl
Coupe ovale Artesano
Plato oval Artesano
Artesano Schale oval

Porcellana - Porcelain

	Cm	In
264 02 53 844	55 x 17	21,5/8 x 6,3/4



Insalatiera Artesano

Artesano salad bowl
Saladier Artesano
Ensaladera Artesano
Artesano Schüssel rund

Porcellana - Porcelain

	Ø Cm	Ø In
264 02 53 170	28	11



Piatto presentazione Artesano

Artesano presentation bowl
Coupe présentation Artesano
Plato presentación Artesano
Artesano Präsentationsschale rund

Porcellana - Porcelain

	Ø Cm	Ø In
264 02 53 760	37	14,1/2





Alzata rettangolare per porcellane

Rectangular podium for porcelain items

Support rectangulaire pour articles en porcelaine

Soporte rectangular para artículos de porcelana

Podest rechteckig für Artikel aus Porzellan

Nero opaco - Matte black

	Cm	H Cm	In	H
305 44 42 624	12 x 40	13,5	4,3/4 x 15,3/4	5,3/4
305 44 42 632	12 x 40	20	4,3/4 x 15,3/4	7,7/8

Cromato - Chromed

	Cm	H Cm	In	H
305 05 42 624	12 x 40	13,5	4,3/4 x 15,3/4	5,3/4
305 05 42 632	12 x 40	20	4,3/4 x 15,3/4	7,7/8



Alzata quadrata

Square podium

Support carré

Soporte cuadrado

Podest quadratisch

Nero opaco - Matte black

	Cm	H Cm	In	H In
305 44 42 621	18 x 18	20	7 x 7	7,7/8
305 44 42 622	18 x 18	25	7 x 7	9,7/8
305 44 42 623	18 x 18	30	7 x 7	11,3/4

Cromato - Chromed

	Cm	H Cm	In	H In
305 05 42 621	18 x 18	20	7 x 7	7,7/8
305 05 42 622	18 x 18	25	7 x 7	9,7/8
305 05 42 623	18 x 18	30	7 x 7	11,3/4







Nature



Secchio champagne

Champagne bucket
Seau à champagne
Cubo champàn
Champagnerkühler

Tiglio - Lime wood

	Ø Cm	Ø In
305 54 43 628	20	7,7/8



Coppa punch

Punch bucket
Bol à punch
Champañera
Punch Bol mit Einsatz

Tiglio - Lime wood

	ØCm	Ø In
305 54 43 629	40	15,3/4



Tagliere con cinghia acciaio

Cutting board with st. steel belt

*Planche à découper**Tabla de cortar con cinturón de acero**Schneidbrett mit Edelstahlband***Noce - Walnut**

	Ø Cm	Ø In
305 04 71 980	40	15,3/4

**Tagliere pane in noce**

Cutting board, walnut wood

*Planche à découper**Brotschneidebrett Walnussholz**Tabla de cortar*

	Cm	In
Tagliere e vassoio - Cutting board with tray		
305 54 54 618	52.5 x 35	20,6 x 13,7

Tagliere - Cutting board		
305 54 54 617	52.5 x 35	20,6 x 13,7

Vassoio - Tray		
305 54 23 854	52.5 x 35	20,6 x 13,7

**Vassoio refrigerato**

Thermal tray

*Plateau réfrigéré**Bandeja refrigerada**Thermo-Platte***Noce - Walnut**

	Cm	In
305 54 52 730	52,5 x 32,5	20,5/8 x 12,3/4



Nature



Set piastra con alzata

Hot buffet set with podium
Buffet chaud avec support
Set plancha con soporte
Hot Buffet Set mit Podest

Nero opaco - Matte black

	Cm	H Cm	In	H In
305 44 54 614	17,5 x 52,5	13,5	6,7/8 x 20,5/8	5,3/4

Cromato - Chromed

	Cm	H Cm	In	H in
305 05 54 614	17,5 x 52,5	13,5	6,7/8 x 20,5/8	5,3/4

Piatto torta con cloche Nature Buffet

Cake plate with Nature Buffet dome cover
Plat à gâteau avec cloche Nature Buffet
Plato tarta con cúpula Nature Buffet
Tortenplatte mit Glocke Nature Buffet

	Ø Cm	Ø In
305 54 42 699	40	15,3/4



Alzata quadrata per piatto torta quadrato

Square podium for square cake plate
Support carré pour plat à gâteau carré
Soporte cuadrado para plato pastel cuadrado
Podest quadratisch

	Cm	H Cm	In	H In
305 54 42 667	26 x 26	20	10,2 x 10,2	7,7/8

● nero - black

305 05 42 667	26 x 26	20	10,2 x 10,2	7,7/8
---------------	---------	----	-------------	-------

● cromato - cromato



Piatto torta con cloche non incluso / Cake plate not included



Cavalletto portaetichetta per buffet

Buffet easel for tags

Chevalet porte-nom pour buffet

Soporte caballete para etiqueta para buffet

Aufsteller Produktinfo

Acciaio inox 18/10 - St. Steel

	Cm	H Cm	In	H In
V01 05 19 001	7 x 7	15	2,3/4 x 2,3/4	6

Tavoletta nera per cavalletto

Black tag for easel

Plaque noire pour chevalet

Etiqueta negra para soporte caballete

Schild für Produktinfo

Plexiglass

	Cm	In
V01 12 19 001	10 x 7,5	4 x 3



Nature

Rinfrescacaaraffe 4 comparti

Thermal pitcher, 4-pc set
Rafraîchisseur à 4 carafes
Enfriador para 4 jarras
Thermo-Karaffeheber 4 Stck.

Noce - Walnut

	Cm	H Cm	In	H In
305 54 24 586	28 x 28	9	11 x 11	3,1/2



Caraffa vetro con coperchio basculante

Glass pitcher Lt.1,5 with rolltop lid
Carafe à eau avec couvercle basculante
Jarra vidrio con tapa giratoria
Wasserkaraffe

ACQUA NATURALE/STILL WATER

	Cm	H Cm	Lt	Oz
305 05 08 548	29	11,4	1	35

ACQUA FRIZZANTE/SPARKLING WATER

	Cm	H Cm	Lt	Oz
305 05 08 549	29	11,4	1	35



Coppa macedonia

Thermal fruit salad bowl
Rafraîchisseur salade de fruits
Bol macedonia de frutas refrigerado
Thermo-Fruchtsalatschale

Noce - Walnut

	Cm	In
305 54 52 641	28 x 28	11 x 11



Set 2 coppe yogurt

Thermal yogurt set, 2-bowl
Set 2 bols yaourt réfrigérés
Set 2 boles yogur refrigerados
Thermo-Schalen 2 Stck.

Noce - Walnut

	Cm	In
305 54 52 640	21,5 x 38,5	8,1/2 x 15,1/8



Rinfrescacaraffe 2 comparti

Double thermal pitcher
Rafraîchisseur à 2 carafes
Enfriador para 2 jarras
Thermo-Karaffenthaler 2 Stck.

Noce - Walnut

	Cm	In
305 54 52 634	21,5 x 38,5	8,1/2 x 15,1/8

**Rinfrescacaraffe 1 comparto**

Thermal pitcher, individual
Rafraîchisseur à carafes individuel
Enfriador de jarras individual
Thermo-Karaffenthaler 1 Stck.

Noce - Walnut

	Cm	In
305 54 52 731	21,5 x 21,5	8,1/2 x 8,1/2

**Caraffa succhi con coperchio**

Juice pitcher with lid
Carafe à jus avec couvercle
Jarra zumo con tapa
Saftkrug mit Deckel

	Lt	Oz
305 05 08 539	1,5	53



Nature

Distributore succhi

Thermal juice dispenser
Distributeur de jus réfrigéré
Dispensador de zumo refrigerado
Thermo-Saftspender

Noce - Walnut

	Lt	Oz	Cm	H Cm	In	H In
305 54 52 644	3,5	122,5	23 x 32	48	9 x 12,5/8	19
305 54 52 633	7	245	28 x 35,5	53	11 x 14	20,7/8



Distributore caffè

Coffee urn
Distributeur de café
Dispensador de café
Kaffeespender

Noce - Walnut

	Lt	Oz	Cm	H Cm	In	H In
305 54 52 631	7	245	28 x 35,5	54	11 x 14	21,1/4
305 54 52 632	10	350	28 x 35,5	62	11 x 14	24,3/8



Distributore cereali

Cereal dispenser
Distributeur céréales
Dispensador cereales
Cerealispender 1-fach

Noce - Walnut

	Lt	Oz	Cm	H Cm	In	H In
305 54 52 636	4	122,5	23 x 32	56	9 x 12,5	22



Vassoio formaggi refrigerato

Thermal cheese/cold cuts tray
 Plateau à fromage/charcuterie réfrigéré
 Bandeja quesos/embutidos refrigerada
 Thermo-Aufschnittplatte

Noce - Walnut

	Cm	H cm	In	H In
305 54 54 577	52 x 32,5	21,5	20,5/8 x 12,3/4	8,1/2



Vassoio refrigerato

Thermal tray, ice packs on demand
 Plateau réfrigéré, blocs réfrigérants sur demande
 Bandeja refrigerada, acumuladores de frío disponibles
 Thermo-Platte, Kühlelemente auf Anfrage

Noce - Walnut

	Cm	H cm	In	H In
305 54 52 699	52.5 x 32.5	4	20,5/8 x 12,3/4	1,5/8



EUTETTICI INCLUSI

ICE PACKS INCLUDED

BLOCS RÉFRIGÉRANTS INCLUS

ACUMULADORE DE FRÍO INCLUIDOS

KÜHLAKKUS INKLUSIVE

Vassoio yogurt refrigerato con ghiaccio

Zeta ice thermal yogurt tray
 Plateau à yaourts réfrigéré à glace Zeta
 Bandeja yogures refrigerable con hielo Zeta
 Joghurtablett Zeta, mit Eis kühlbar

Noce - Walnut

	Cm	H cm	In	H In
305 54 52 638	52.5 x 32.5	4	20,5/8 x 12,3/4	1,5/8



Jambee

Jambee distributore marmellata/miele con base in legno

Jambee jam/honey dispenser with wood base

Distributeur confiture/miel Jambee avec base en bois

Jambee distribuidor de mermelada/miel con base de madera

Jambee Konfitür/honigspender mit Holzbasis

Noce - Walnut

	Lt	Oz	Cm	In
305 05 52 721	0,7	23	12,5 x 34,5 H Min 40,5 H Ma x 54	5 x 13,5/8 H Min 16 H Ma x 21,1/4
305 05 52 722	1	33,8	12,5 x 34,5 H Min 48 H Ma x 70	5 x 13,5/8 H Min 18,7/8 H Ma x 27,1/2



Jambee

Jambee

Jambee

Jambee

Jambee

Acciaio Inox 18/10 - St. Steel

	Lt	Oz	Cm	In
V77 0552 DMB	0,7	23	12,5 x 34,5 H Min 39 H Ma x 54	5 x 13,5/8 H Min 15,3/8 H Ma x 21,1/4
V77 0552 DMC	1	33,8	12,5 x 34,5 H Min 47 H Ma x 69	5 x 13,5/8 H Min 18,1/2 H Ma x 27,1/8



Erogatore a siringa

Syringe nozzle
 Embout seringue
 Ausgieberspritze
 Boquilla jeringa

Inox 18/10 - St. Steel

Z77 4652 DMA



Pistone con coperchio

Piston with lid
 Piston avec couvercle
 Kolben mit Deckel
 Pistón con tapa

Inox 18/10, Metacrilato e PP - St. Steel, Methacrylate and PP

	Lt
Z77 9852 DMA	0,7
Z77 9852 DMA1	1



Contentitore

Container
 Conteneur
 Behälter
 Contenedor

Metacrilato - Methacrylate

	Lt
Z77 2052 DMA	0,7
Z77 2052 DMA1	1

Tappo

Cap
 Capsule
 Stöpsel
 Tapón

Metacrilato - Methacrylate

Z77 1352 DMA

Targhetta porta etichetta

Label plate
 Plaque porte-étiquette
 Schild Etikettenhalter
 Placa porta etiqueta

Metacrilato - Methacrylate

Z77 5752 DMA1





Zeta Buffet



Distributore caffè

Coffee urn
Distributeur de café
Dispensador de café
Kaffeespender

	Lt	Cm	H Cm
305 05 52 631 <input checked="" type="checkbox"/>	7	25 x 35	54
305 45 52 631 <input type="checkbox"/>			
305 05 52 632 <input checked="" type="checkbox"/>	10	25 x 35	62
305 45 52 632 <input type="checkbox"/>			



Distributore succhi refrigerato

Thermal juice dispenser
Distributeur de jus réfrigéré
Dispensador de zumo refrigerado
Thermo-Saftspender

	Lt	Cm	H Cm
305 05 52 633 <input checked="" type="checkbox"/>	7	25 x 35	53
305 45 52 633 <input type="checkbox"/>			
305 05 52 644 <input checked="" type="checkbox"/>	3,5	18 x 30	48
305 45 52 644 <input type="checkbox"/>			



Distributore cereali

Cereal dispenser
 Distributeur céréales
 Dispensador cereales
 Cerealienspender 1-fach

305 05 52 636
 305 45 52 636

Kg	Cm	H Cm
1,5	15 x 24	58

**Distributore cereali 2 comparti**

Double cereal dispenser
 Distributeur céréales double
 Dispensador cereales doble
 Cerealienspender 2-Fach

305 05 52 635
 305 45 52 635

Kg	Cm	H Cm
2 x 1,5	25 x 32	58



Zeta



Rinfrescacaraffe 2 comparti

Double thermal pitcher
Rafraîchisseur à 2 carafes
Enfriador para 2 jarras
Thermo-Karaffenhalter 2 Stck.

	Cm	H Cm	Lt
305 05 52 634 ■	42 x 24	22	1,5
305 45 52 634 □			

**Caraffa succhi con coperchio**

Juice pitcher with lid
Carafe à jus avec couvercle
Jarra zumo con tapa
Saftkrug mit Deckel

	Lt	Oz
305 05 08 539	1,5	53

**Rinfrescacaraffe 4 comparti acciaio inox**

Thermal pitcher 4-pc set
Rafraîchisseur à 4 carafes
Enfriador para 4 jarras
Thermo-Karaffehalter 4 Stck.

	Cm	In	H Cm	H In
305 05 24 586 ■	30 x 30	11,8 x 11,8	8,5	3,3
305 45 24 586 □				

* caraffe incluse / included pitcher

**Caraffa vetro con coperchio basculante**

Glass pitcher Lt.1,5 with rolltop lid
Carafe à eau avec couvercle basculante
Jarra vidrio con tapa giratoria
Wasserkaraffe

ACQUA NATURALE/STILL WATER

	Cm	H Cm	Lt	Oz
305 05 08 548	29	11,4	1	35

ACQUA FRIZZANTE/SPARKLING WATER

	Cm	H Cm	Lt	Oz
305 05 08 549	29	11,4	1	35



Rinfrescabottiglie termico 3 posti

3-bottle cooler
Rafraichisseur à 3 bouteilles
Enfriador para 3 botellas
Flaschenkühler 3-Fach

305 05 52 646 ■ Cm H Cm
 42 x 24 23,5
 305 45 52 646 □



Set 2 coppe yogurt refrigerate

Thermal yogurt set, 2-bowl
Set 2 bols yaourt réfrigérés
Set 2 boles yogur refrigerados
Thermo-Schalen 2 Stck.

305 05 52 640 ■
 305 45 52 640 □
 Cm 42 x 24 x H. 13,5 Ø 15 Cm Lt 0,5



Set 2 coppe macedonia refrigerate

Thermal fruit-salad set, 2-bowl
Set 2 bols salade de fruits réfrigérés
Set 2 boles macedonia de frutas refrigerados
Thermo-Fruchtsalatschale 2 Stck. schwarz

305 05 52 637 ■
 305 45 52 637 □
 Cm 55 x 34,5 x H 16 Ø 23 Cm Lt 1,8



Coppa macedonia refrigerata

Thermal fruit salad bowl
Rafraichisseur salade de fruits
Bol macedonia de frutas refrigerado
Thermo-Fruchtsalatschale

305 05 52 641 ■
 305 45 52 641 □
 Cm 30 x 30 x H 16 Ø 23 Cm Lt 1,8





Supporto alto per 3 coppette

3-bowl podium, tall
Support haut à 3 coupelles
Soporte alto para 3 boles
Buffetständer 3 Bowlst

	Cm	H Cm	Ø Cm	Lt.
305 05 54 580 ■	42,5 x 15	19	12	0,25
305 45 54 580 □				

Supporto basso per 3 coppette

Podium 3-bowl, short
Support bas à 3 coupelles
Soporte bajo para 3 boles
Buffetständer 3 Bowlst

	Cm	H Cm	Ø Cm	Lt.
305 05 54 579 ■	42,5 x 15	11,5	12	0,25
305 45 54 579 □				

Coperchio in metacrilato con pom. per coppa

Bowl cover
Couvercle metachrilè pour coupe en verre
Tapa acrílica con pom. para boles
Acryldeckel m. Griff f. Glassch.

	Ø Cm
305 12 15 798	12



Supporto alto per 2 coppe cereali con coperchio

2-bowl podium with lids, tall
Support haut à 2 coupes avec couvercles
Soporte alto para 2 boles con tapas
Buffetständer 2 Bowlst mit Deckel

	Cm	H. Cm	Ø Cm	Lt
305 05 54 607 ■	62 x 28	30	23	1,8
305 45 54 607 □				

Supporto basso per 2 coppe cereali con coperchio

2 bowl podium with lids, short
Support bas à 2 coupes avec couvercles
Soporte bajo para 2 boles con tapas
Buffetständer 2 Bowlst mit Deckel

	Cm	H Cm	Lt
305 05 54 606 ■	55 x 28	10	1,8
305 45 54 606 □			





Vassoio formaggi ed affettati refrigerato

Thermal cheese/cold cuts tray
 Plateau à fromage/charcuterie réfrigéré
 Bandeja quesos/embutidos refrigerada
 Thermo-Aufschnittplatte

	Cm	H Cm
305 05 54 577 <input checked="" type="checkbox"/>	55 x 34,5	20
305 45 54 577 <input type="checkbox"/>		



Vassoio refrigerato, eutetici a richiesta

Thermal tray, ice packs on demand
 Plateau réfrigéré, blocs réfrigérants sur demande
 Bandeja refrigerada, acumuladores de frío disponibles
 Thermo-Platte, Kühlelemente auf Anfrage

	Cm	H Cm
305 05 52 699 <input checked="" type="checkbox"/>	55 x 34,5	4
305 45 52 699 <input type="checkbox"/>		



Vassoio yogurt Zeta refrigerato con ghiaccio

Zeta ice thermal yogurt tray
 Plateau à yaourts réfrigéré à glace Zeta
 Bandeja yogures refrigerable con hielo Zeta
 Joghurttablett Zeta, mit Eis kühlbar

	Cm	H Cm
305 05 52 638 <input checked="" type="checkbox"/>	55 x 34,5	4
305 45 52 638 <input type="checkbox"/>		



Cestino pane acciaio inox

Bread basket with roll-top cover
 Corbeille à pain avec couvercle roll-top
 Cesta pan con tapa roll-top
 Brotkorb mit Rolltop

	Cm	H Cm
305 05 52 650 <input checked="" type="checkbox"/>	55 x 34,5	25
305 45 52 650 <input type="checkbox"/>		

**Cestino portapane con cloche**

Bread basket with roll-top cover
 Corbeille à pain avec couvercle roll-top
 Cesta pan con tapa roll-top
 Rattan Brotkorb mit Rolltop

	Cm	H Cm
305 05 52 642 <input checked="" type="checkbox"/>	55 x 34,5	30
305 45 52 642 <input type="checkbox"/>		

**Tagliere pane con base**

Bread cutting board with base
 Planche à pain avec plateau
 Tabla de cortar con base
 Brotschneidebrett

	Cm	H Cm
305 05 54 578 <input checked="" type="checkbox"/>	55 x 34,5	6
305 45 54 578 <input type="checkbox"/>		



Scaldabrioche

Croissant warmer
 Chauffe-croissants
 Calienta croissants
 Croissantwärmer



Cm	H Cm
55 x 34,5	24,3

305 05 52 651 ■
 305 45 52 651 □



Alzata filo per basi GN 1/1

Wire stand for GN 1/1
 Support en fil pour GN 1/1
 Soporte en hilo para GN 1/1
 Buffetständer mit GN 1/1 Einsatz

Cm	H Cm
305 05 42 597 57,5 x 35,8	27,6



Supporto con schermo igienico GN 1/1

Stand with hygienic shield
 Ecran hygiénique
 Pantalla higiénica
 Buffetständer mit Hygieneplatte

Cm
305 12 53 609 59 x 34,4



Alzata torta con cloche

Cake stand with roll-top cover
 Présentoir à gâteau x avec couvercle roll-/top
 Presentación tarta con tapa roll-top
 Tortenplatte mit Rolltop

	Ø Cm	Base Cm	H Cm
305 05 42 600 <input checked="" type="checkbox"/>	38	18 x 18	37,2
305 45 42 600 <input type="checkbox"/>			



Coppa punch

Punch bowl
 Bol à punch
 Champañera
 Punch Bowl

	Ø Cm	Base Cm	H Cm
305 05 43 613 <input checked="" type="checkbox"/>	40	18 x 18	33
305 45 43 613 <input type="checkbox"/>			



Vassoio multifunzione rettangolare

Ectangular multipurpose tray
 Plateau multi-usage rectangulaire
 Bandeja multiuso rectangular
 Multifunktionstablett rechteckig

	Cm	H Cm
305 05 52 652 <input checked="" type="checkbox"/>	55 x 34,5	4
305 45 52 652 <input type="checkbox"/>		



Vassoio multifunzione quadrato

Square multipurpose tray
 Plateau multi-usage carré
 Bandeja multiuso cuadrada
 Multifunktionstablett viereckig

	Cm	H Cm
305 05 52 654 <input checked="" type="checkbox"/>	30 x 30	4
305 45 52 654 <input type="checkbox"/>		





Manhattan Buffet



Manhattan

SET 1

Manhattan Tower
Tower Manhattan
Tower Manhattan
Manhattan Tower

305 05 52 A01 Cm H Cm
 140 x 42 65



SET 2

Manhattan Tower
Tower Manhattan
Tower Manhattan
Manhattan Tower

305 05 52 A02 Cm H Cm
 140 x 42 50



SET 3

Manhattan Tower
Tower Manhattan
Tower Manhattan
Manhattan Tower

305 05 52 A03 Cm H Cm
 150 x 145 65



SET 4

Manhattan Tower
Tower Manhattan
Tower Manhattan
Manhattan Tower

305 05 52 A04 Cm H Cm
 260 x 42 65



Tower

Tower
Tower
Tower
Tower

	Cm	H Cm
305 05 42 604	20 x 20	10
305 05 42 605	20 x 20	22
305 05 42 606	20 x 20	34
305 05 42 607	20 x 20	58



Modulo a croce

Cross-shaped e x tension unit
Croi x
Módulo con forma de cruz
Verbindungskreuz

	H Cm
305 05 42 608	9,5

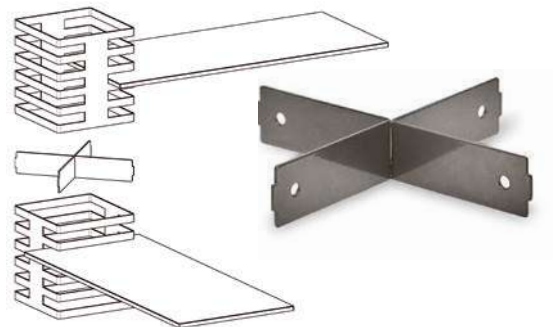

Coppa quadrata in vetro

Bowl, square, glass
Bol carré en verre
Bol cuadrado de cristal
Quadratische Glasschale

	Cm	H cm
V87 04 42 Q01	34 x 34	11



Manhattan

Piano in vetro fumé

Smoky glass top

Dessus en verre fumé

Tablero de cristal fumé

Glasplatte Smoky

	Cm
V87 08 42 Q01	30 x 30
V87 08 42 Q02	42 x 42
V87 08 42 R01	30 x 70
V87 08 42 R02	30 x 100
V87 08 42 R03	42 x 70
V87 08 42 R04	42 x 100



Piano in ardesia

Slate top

Dessus en ardoise

Tablero de pizarra

Schieferplatte

	Cm
V87 09 42 Q01	30 x 30
V87 09 42 Q02	42 x 42
V87 09 42 R01	30 x 70
V87 09 42 R02	30 x 100
V87 09 42 R03	42 x 70
V87 09 42 R04	42 x 100



Piano in mdf

Mdf top

Dessus en mdf

Tablero de mdf

Mdf Platte

	Cm
V87 04 42 Q01	30 x 30
V87 04 42 Q02	42 x 42
V87 04 42 R01	30 x 70
V87 04 42 R02	30 x 100
V87 04 42 R03	42 x 70
V87 04 42 R04	42 x 100



Totem

Totem

Totem

Totem

Totem

	Cm	H Cm
305 05 42 609	24 x 24	14
305 05 42 610	24 x 24	22
305 05 42 611	32,5 x 32,5	14
305 05 42 612	32,5 x 32,5	22





Caratteristiche tecniche

- A** Asportabilità del coperchio a 90° con estrema facilità.
- B** Coperchio leggero e facilmente maneggiabile.
- C** Blocco automatico dell'estrazione del coperchio in fase di lavoro (da 0° a 89°).
- D** Chiusura e apertura frenata del coperchio. Sistema di cerniere brevettate Abert
- E** Superati i 70° il coperchio si apre completamente lasciandolo andare.
- F** La cerniera è un meccanismo a molla, inalterabile nel tempo, non necessita di regolazione e di manutenzione in quanto non ha frizione.
- G** Tutti i meccanismi sono costruiti in pregiati materiali inossidabili, quindi resistenti alla corrosione, agli ambienti umidi e adatti al contatto con gli alimenti.
- H** Lo scaldavivande è progettato per raccogliere la condensa in modo da lasciare il piano di appoggio completamente asciutto.
- I** Può essere utilizzato sia con riscaldamento elettrico sia con fornelli a combustibile solido.

Technical characteristics

- A** Easily removable cover, at 90°.
- B** Light and easy-to-handle cover.
- C** Automatic block of cover pull out when in operation (from 0° to 89°).
- D** Closing and opening slowed by cover. Abert patented system.
- E** Over 70° the cover opens fully when released.
- F** The hinge is a spring mechanism, inalterable in time, it does not need regulation and maintenance as it has no clutch.
- G** All the machineries are built in refined stainless materials, thus resistant to corrosion, humid environment and suitable for food contact.
- H** The chafing dish is designed to collect condensation, In order to keep the support base completely dry.
- I** Both electric warming and solid-fuelburners can be used.



Piastra elettrica Gn 2/3

Electric plate for Ø Cm 30-40 round chafing dish
Élément électrique pour chafing-dish rond Ø Cm 30-40
Elemento eléctrica para chafing dish redondo Ø Cm 30-40
Elektroelement für runden Chafing Dish Ø Cm 30-40

305 05 52 546

305 05 52 611 con regolatore - with regulator



Piastra elettrica Gn 1/1

Electric hot plate
Plaque électrique
Placa eléctrica
Elektrische Platte

305 05 52 547

V77 05 52 PCR2 con regolatore - with regulator



Fornelletto per scaldavivande

Chafing-dish burner
Porte brûleur pour chafing dish
Contenedor de combustible para chafing dish
Brennstoffhalter für Chafing Dish

305 05 52 536



Combustibile per scaldavivande

Solid fuel for chafing dish burner
Combustible pour chafing dish
Combustible para chafing dish
Brennstoff für Chafing Dish

305 05 72 519



Scaldavivande con gambe e coperchio in acciaio inox

Chafing dish with St. Steel stand and cover
 Chafing dish avec support et couvercle en acier inox
 Chafing dish con soporte y tapa en acero inox
 Chafing Dish mit Beinen und Edelstahldeckel

	Cm	H Cm
GN 1/1		
305 05 52 670	63 x 42	31
GN 2/3		
305 05 52 675	46 x 42	32

Completo di due fornelli a combustibile solido e predisposto per piastra elettrica.
 Portavivande GN 1/1 in acciaio incluso

*With 1/1 Gastronorm food pan and two solid fuel burners.
 Electric heating element available.*



Scaldavivande con gambe e coperchio acciaio inox /vetro

Chafing dish with St. Steel/glass stand and cover
 Chafing dish avec support et couvercle en acier inox / verre
 Chafing dish con soporte y tapa en acero inox / vidrio
 Chafing Dish mit Beinen und Edelstahl / Glass deckel

	Cm	H Cm
GN 1/1		
305 05 52 679	63 x 43	33
GN 2/3		
305 05 52 683	46 x 42	32

Completo di due fornelli a combustibile solido e predisposto per piastra elettrica
 Portavivande GN 1/1 in acciaio incluso

*With 1/1 Gastronorm food pan and two solid fuel burners.
 Electric heating element available.*



Scaldavivande da incasso con coperchio in acciaio inox / vetro

Built-in chafing dish with St. Steel / glass cover
Chafing dish encastrable avec couvercle en acier inox / verre
Chafing dish para empotrar con tapa en acero inox / vidrio
Chafing Dish zum Einbauen mit Edelstahl / Glass Deckel

	Cm	H Cm
GN 1/1		
305 05 52 692	60,5 x 40	39,5
GN 2/3		
305 05 52 694	43 x 40	21

Refrigerato / Thermal

GN 1/1		
305 05 52 705	60,5 x 40	39,5

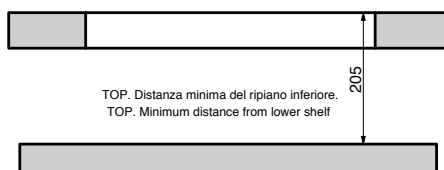
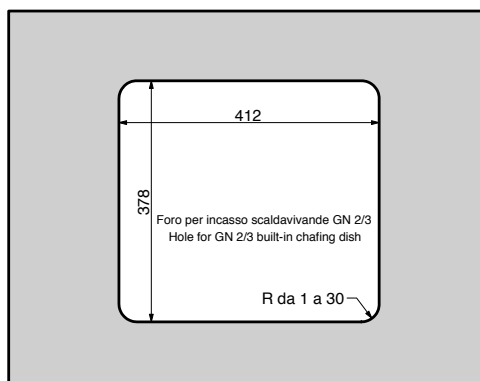

Scaldavivande da incasso con coperchio in acciaio inox

Built-in chafing dish with St. Steel cover
Chafing dish encastrable avec couvercle en acier inox
Chafing dish para empotrar con tapa en acero inox
Chafing Dish zum Einbauen mit Edelstahl Deckel

	Cm	H Cm
GN 1/1		
305 05 52 693	60,5 x 40,5	39,5
GN 2/3		
305 05 52 695	43 x 40	21

Refrigerato / Thermal

GN 1/1		
305 05 52 706	60,5 x 40,5	39,5

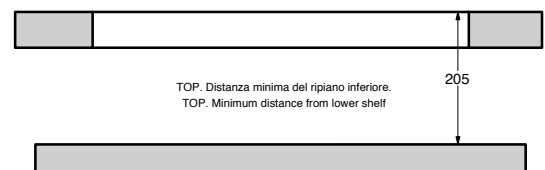
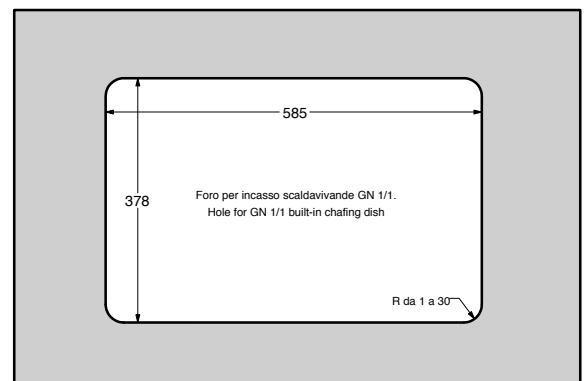



Scaldavivande a incastro GN 1/1

GN 1/1 built-in chafing dish
Chafing dish encastrable GN 1/1
Chafing dish empotrable GN 1/1
Eingebautes Chafing Dish GN 1/1

305 05 52 665

Con coperchio in acciaio inox
With Stainless steel cover

305 05 52 678

Con coperchio in vetro
With glass cover

Completo di due fornelli a combustibile solido e predisposto per piastra elettrica.
 Portavivande GN 1/1 in acciaio incluso
 Supporti Manhattan esclusi

*With 1/1 Gastronorm food pan and two solid fuel burners.
 Electric heating element available.
 Manhattan stand e x cluded*

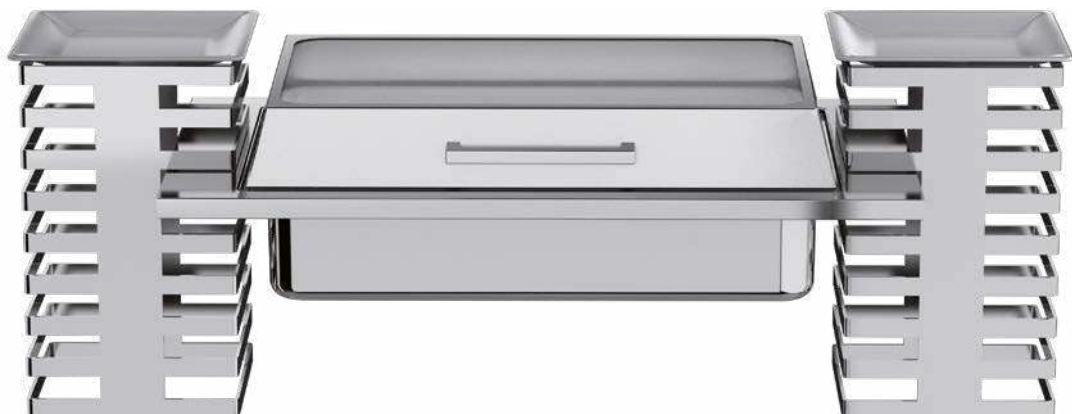

Set refrigerato a incastro GN 1/1

GN 1/1 built-in thermal set
Set réfrigéré encastrable GN 1/1
Set refrigerado empotrable GN 1/1
Eingebautes Thermo-Einsatz GN 1/1

305 05 52 698

Con coperchio in vetro
With glass cover

Set refrigerato GN 1/1 H.7,2 Cm completo di bacinella in acciaio inox , griglia in acciaio inox , eutettici, vassoio GN 1/1 H.Cm 2 in acciaio inox .
 Supporti Manhattan esclusi

*Thermal set GN 1/1 H. 7,2 Cm with St. Steel pan, St. Steel grid, ice packs,
 St. Steel tray GN 1/1 H. Cm 2.
 Manhattan stand e x cluded*

Set refrigerato Manhattan affettati e formaggi

Manhattan thermal set, cold cuts/cheese

Set réfrigéré Manhattan charcuterie(fromages)

Set refrigerado Manhattan embutidos y quesos

Gekühltes Set Manhattan für Aufschnitt und Käse

Cm h

305 05 52 767 62 x 42 22

GN 1/1 PORCELLANA H 2 Cm

+ inglese (GN 1/1 PORCELLANA H 2 Cm)



Set refrigerato Manhattan per frutta

Manhattan thermal set for fruit

Set réfrigéré Manhattan pour fruits

Set refrigerado Manhattan para frutas

Gekühltes Set Manhattan für Obst

Cm h

305 05 52 766 62 x 42 22

3 x GN 1/3 PORCELLANA H 6,5 Cm

+inglese (3 x GN 1/3 PORCELLANA H 6,5 Cm)



Set refrigerato Manhattan da appoggio

Manhattan thermal set (cold), self-standing

Set réfrigéré Manhattan à poser

Set refrigerado Manhattan sobre encimera

Manhattan Thermoset (kalt), selbststehend

Cm h

305 05 52 764 62 x 42 22

GN 1/1 ACCIAIO H 6,5 Cm

+inglese (GN 1/1 ACCIAIO H 6,5 Cm)



Set riscaldato Manhattan da appoggio

Manhattan thermal set (hot), self-standing

Set chauffant Manhattan à poser

Set calentador Manhattan sobre encimera

Manhattan Thermoset (heiß), selbststehend

Cm h

305 05 52 765 62 x 42 22

GN 1/1 ACCIAIO H 6,5 Cm

+inglese (GN 1/1 ACCIAIO H 6,5 Cm)



Inserto GN 1/1 in acciaio inox

Food pan, GN 1/1 18/10, stainless steel

V01 05 72 G11B

H. 6,5 Cm



Vassoio GN 1/1 in acciaio inox

Tray, Gn 1/1, stainless steel

V01 05 72 G11

H. 2 Cm



Inserto GN 2/3 in acciaio inox

Food pan, GN 2/3 18/10, stainless steel

V01 05 72 G23B

H. 6,5 Cm



Inserto GN 1/3 in acciaio inox

Food pan, GN 1/3 18/10, stainless steel

V01 05 72 G13B

H. 6,5 Cm



Inserto GN 1/2 in acciaio inox

Food pan, GN 1/2 18/10, stainless steel

V01 05 72 G12B

H. 6,5 Cm



Inserto GN 1/1 in porcellana

Food pan, GN 1/1, porcelain

305 21 52 557

H. 6,5 Cm



Inserto GN 1/1 in porcellana

Food pan, GN 1/1, porcelain

3052152672

H. 2 Cm



Inserto GN 2/3 in porcellana

Food pan, GN 2/3, porcelain

305 21 52 583

H. 6,5 Cm



Inserto GN 1/2 in porcellana

Food pan, GN 1/2, porcelain

305 21 52 581

H. 6,5 Cm



Inserto GN 1/3 in porcellana

Food pan, GN 1/3, porcelain

305 21 52 582

H. 6,5 Cm



Piatto piano quadrato in porcellana

Square flat plate, porcelain

263 33 42 649

22 x 22 Cm



Piatto fondo quadrato in porcellana

Square deep plate, porcelain

263 33 42 130

22 x 22 Cm





A still life composition featuring a silver buffet tray with fruit, a white bowl of pears, and books on a wooden table in front of a bookshelf. The tray holds several slices of watermelon, a cantaloupe, and a kiwi. To the left, a white bowl is filled with yellow pears. In the foreground, two books (one blue, one red) are stacked on the table. The background is a white-painted wooden bookshelf filled with various books. The text "Classica Buffet" is overlaid in the center.

Classica Buffet

Classica

Distributore caffè linea classica

Classica coffee urn

Distributeur de café Classica

Dispensador de café Classica

Kaffeedispenser Classica

	Lt	Oz	Cm	H Cm
303 ... 52 549	7	245	32 x 25	53
303 ... 52 550	10	350	24 x 32	52



Distributore succhi linea classica

Classica juice dispenser

Distributeur de jus Classica

Dispensador de zumo Classica

Saftspender Classica

	Lt	Oz	Cm	H Cm
303 ... 52 603	8	280	25 x 36	72



**Piastra elettrica
per distributore caffè**

**Electric heating
element for coffee urn**



**Piastra elettrica rettangolare
per scaldavivande gn 1/1**

**Electric heating element
for GN1/1 rectangular chafing dish**



COD. 303 07..... acciaio argentato - electro-plated stainless steel (EPSS)
 COD. 303 03..... acciaio argentato e ottone - electro-plated stainless steel (EPSS) and brass
 COD. 303 05..... acciaio e ottone - stainless steel and brass
 COD. 303 55..... acciaio inossidabile - stainless steel

Scaldavivande tondo linea Classica

Classica round chafing dish
 Chafing dish rond Classica
 Chafing dish redondo Classica
 Chafing Dish Classica, rund

	Ø Cm	Ø In
303 .. 52 614	40	15,3/4

Con cloche rotante (180°) a scomparsa, fornito di portavivande Gastronorm e due bruciatori a combustibile solido. Predisposto per piastra elettrica.

*With revolving foldaway dome opening at 180°, Gastronorm food pan and two solid fuel burners.
 Electric heating element available.*



Scaldavivande rettangolare linea Classica

Classica rectangular chafing dish
 Chafing dish rectangulaire Classica
 Chafing dish rectangular Classica
 Chafing Disch Classica , rechteckig

	GN	In	Cm	H Cm
303 .. 52 612	1/1	1/1	67 x 43	45

Con cloche rotante (180°) a scomparsa, fornito di portavivande 1/1 Gastronorm e due bruciatori a combustibile solido. Predisposto per piastra elettrica.

*With revolving foldaway dome opening at 180°, 1/1 Gastronorm food pan and two solid fuel burners.
 Electric heating element available.*



Piastra elettrica per scaldavivande tondo Ø Cm 30-40

Electric heating element for Ø Cm 30-40 chafing dish



Fornelletto per scaldavivande

Chafing dish burner



Classica

Alzata rettangolare linea Classica

Classica rectangular stand
Présentoir rectangulaire Classica
Soporte rectangular Classica
Rechteckiger Ständer, Classica

	Cm	In	H. Cm.	H In	
303 .. 52 702	28 x 49	11 x 19,1/4	21	8,1/4	

Vassoio refrigerato - Thermal tray

305 .. 54 611 GN 1/1



Alzata tonda linea Classica

Classica round stand
Présentoir rond Classica
Soporte redondo Classica
Runder Ständer, Classica

	Ø Cm	Ø In	H Cm.	H In	
303 .. 52 703	22	8,5/8	21	8,1/4	

Ciotola in porcellana - porcelain bowl

264 02 53 170 28 11



COD. 305 07..... acciaio argentato - electro-plated stainless steel (EPSS)
 COD. 305 03..... acciaio argentato e ottone - electro-plated stainless steel (EPSS) and brass
 COD. 305 05..... acciaio e ottone - stainless steel and brass
 COD. 305 55..... acciaio inossidabile - stainless steel

Distributore Aqva con alzata Classica

Aqva dispenser with Classica stand
 Distributeur Aqva avec support Classica
 Dispensador Aqva con soporte Classica
 Aqua Getränkespender mit Ständer Classica

	Ø Cm	H Cm	Ø In	H In
305 .. 52 712	27	63	10,5/8	24,8



Coppa punch con manici Rubans

Punch bowl with Rubans handles
 Bol à punch avec poignées Rubans
 Champañera con asas Rubans
 Punschschale mit Griff Rubans

	Ø Cm	Lt	Ø In	Oz
310 00 43 602	50	20	19,3/4	700





Alzata frutta 2-3-4 piani

Fruit stand, 2-3-4-tier

Plat à fruits sur pied, 2-3-4 étages

Frutero, 2-3-4 pisos

Obstständler, 2-3-4 stufig

		Ø Cm	H Cm	Ø In	H In
310 00 42 564	(2 piani / 2 tier)	30/25	49	11,3/4-9,7/8	19,5/16
310 00 42 565	(3 piani / 3 tier)	40/30/25	69	15,3/4-11,3/4-9,7/8	27
310 00 42 577	(3 piani / 3 tier)	54/40/30	69	21,1/4-15,3/4-11,3/4	27
310 00 42 571	(4 piani / 4 tier)	54/40/30/25	90	21,1/4-15,3/4-11,3/4-9,7/8	35,3/8

COD. 303 07..... acciaio argentato - electro-plated stainless steel (EPSS)
 COD. 303 03..... acciaio argentato e ottone - electro-plated stainless steel (EPSS) and brass
 COD. 303 05..... acciaio e ottone - stainless steel and brass
 COD. 303 55..... acciaio inossidabile - stainless steel

Alzata frutta

Fruit stand
 Plat à fruits sur pied
 Frutero
 Obstständer

	Ø Cm	Ø In
310 00 42 574	30	11,3/4
310 00 42 539	40	15,3/4
310 00 42 549	54	21,1/4



Alzata frutta

Fruit stand
 Plat à fruits sur pied
 Frutero
 Obstständer

	Ø Cm	Ø In
310 00 42 535	30	11,3/4



Alzata torta

Cake stand
 Presentoir à gâteau x
 Soporte pastel
 Tortenplatte

	Ø Cm	Ø In
310 00 42 526	32	12,5/8



Portaburro tondo

Butter cooler, round
Beurrier rond
Mantequera redonda
Butterkühler, rund

	Ø Cm	H Cm	Ø In	H In
V77 05 09 T32	32	6	12,5/8	2,3/8



Portaformaggi / affettati rettangolare refrigerato - piano in polietilene

Rectangular cheese / cold cuts dish, thermal - Polyethylene board
Plateau fromage / charcuterie rectangulaire réfrigérant - Planche en polyéthylène
Quesera rectangular refrigerante - Tabla de polietileno
Käse/Wurstwarenplatte - rechteckig, gekühlt, Platte aus Acryl

	Cm	In
V77 05 54 G11 R	53 x 32,5	20,7/8 x 12,3/4



Portaformaggi / affettati tondo refrigerato - piano in polietilene

Round cheese / cold cuts dish, thermal - Polyethylene board
Plateau fromage / charcuterie rond réfrigérant - Planche en polyéthylène
Quesera redonda refrigerante - Tabla de polietileno
Käse/Wurstwarenplatte - rund, gekühlt, Platte aus Acryl

	Ø Cm	Ø In
V77 05 54 T46 R	46	18,1/8



COD. 303 07..... acciaio argentato - electro-plated stainless steel (EPSS)
 COD. 303 03..... acciaio argentato e ottone - electro-plated stainless steel (EPSS) and brass
 COD. 303 05..... acciaio e ottone - stainless steel and brass
 COD. 303 55..... acciaio inossidabile - stainless steel

**Caraffa vetro acqua frizzante
 con coperchio basculante**

Sparkling water glass pitcher with smart lid
 Carafe en verre à eau gazeuse
 avec couvercle basculant
 Jarra de vidrio agua con gas con tapa basculante
 Wasser Karaffe (Kohlen säüve) mit Kippen Kappe

	Lt	Oz
305 05 08 549	1	35



**Caraffa vetro
 con coperchio basculante**

Water glass pitcher with smart lid
 Carafe en verre avec couvercle basculant
 Jarra de vidrio con tapa basculante
 Wasser Karaffe mit Kippen Kappe

	Lt	Oz
305 05 08 548	1	35

Caraffa succhi con coperchio

Juice pitcher with lid
 Carafe à jus avec couvercle
 Jarra zumo con tapa
 Saftkrug mit Deckel

	Lt	Oz
305 05 08 539	1,5	53



Caraffa succhi

Juice pitcher
 Carafe à jus
 Jarra zumo
 Saftkrug
 (Argentata - silver plated)

	Lt	Oz
310 07 08 546	2,0	70



Caraffa termica

Insulated beverage server

Pot isotherme

Jarra térmica

Termische Karaffe

	Lt	Oz
305 05 08 540	0,60	21
305 05 08 541	1,00	35
305 05 08 542	1,50	53



Caraffa termica conica

Insulated beverage server, conical

Pot isotherme conique

Jarra térmica cónica

Thermische Karaffe, konisch

	Lt	Oz
305 05 08 557	0,30	10
305 05 08 558	0,60	21
305 05 08 559	1,00	35
305 05 08 560	1,50	53



COD. 303 07..... acciaio argentato - electro-plated stainless steel (EPSS)
 COD. 303 03..... acciaio argentato e ottone - electro-plated stainless steel (EPSS) and brass
 COD. 303 05..... acciaio e ottone - stainless steel and brass
 COD. 303 55..... acciaio inossidabile - stainless steel

Caraffa termica cilindrica

Thermal beverage server, cylindrical

Pot isotherme cylindrique

Jarra térmica cilíndrica

Termische Karaffe, zylindrische

Acciaio inossidabile - St. Steel

	Lt	Oz
305 05 08 540	0,60	21
305 05 08 541	1,00	35
305 05 08 542	1,50	53

305 42 08 ...	coperchio black - black lid
305 40 08 ...	coperchio copper - copper lid
305 41 08 ...	coperchio gold - gold lid



Caraffa termica conica

Thermal beverage server, conical

Pot isotherme conique

Jarra térmica cónica

Termische Karaffe, konisch

Acciaio inossidabile - St. Steel

	Lt	Oz
305 05 08 557	0,30	10
305 05 08 558	0,60	21
305 05 08 559	1,00	35
305 05 08 560	1,50	53

305 42 08 ...	coperchio black - black lid
305 40 08 ...	coperchio copper - copper lid
305 41 08 ...	coperchio gold - gold lid



ChafingDishAccessories

Inserto GN 1/1 in acciaio inox

Food pan, GN 1/1 18/10, stainless steel

V01 05 72 G11B

H. 6,5 Cm



Vassoio GN 1/1 in acciaio inox

Tray, Gn 1/1, stainless steel

V01 05 72 G11B

H. 2 Cm



Inserto GN 2/3 in acciaio inox

Food pan, GN 2/3 18/10, stainless steel

V01 05 72 G23B

H. 6,5 Cm



Inserto GN 1/3 in acciaio inox

Food pan, GN 1/3 18/10, stainless steel

V01 05 72 G13B

H. 6,5 Cm



Inserto GN 1/2 in acciaio inox

Food pan, GN 1/2 18/10, stainless steel

V01 05 72 G12B

H. 6,5 Cm



Inserto GN 1/1 in porcellana

Food pan, GN 1/1, porcelain

305 21 52 557

H. 6,5 Cm



Inserto GN 1/1 in porcellana

Food pan, GN 1/1, porcelain

3052152672

H. 2 Cm



Inserto GN 2/3 in porcellana

Food pan, GN 2/3, porcelain

305 21 52 583

H. 6,5 Cm



Inserto GN 1/2 in porcellana

Food pan, GN 1/2, porcelain

305 21 52 581

H. 6,5 Cm



Inserto GN 1/3 in porcellana

Food pan, GN 1/3, porcelain

305 21 52 582

H. 6,5 Cm



Set minestre per scaldavivande rettangolare

Soup tureen set for rectangular chafing dish
Set de soupieres pour chafing dish rectangulaire
Set de soperas para chafing dish rectangular
Suppenhüßelset für Chafing Dish rechteckig

		Cm	In
305 05 52 626	Adattatore - Adapter	1/1	1/1
		Lt	Oz
305 05 15 796	Zuppiera - Soup tureen	4,2	142



Portavivande tondo in acciaio inossidabile

Round food pan, stainless steel
Bac rond en acier inox idable
Cubeta redonda en acero inox idable
Behälter rund, edelstahl rostfrei

	Ø Cm	Ø In
305 05 72 517	40	15,3/4



Portavivande tondo in porcellana

Round food pan, porcelain
Bac rond en porcelaine
Cubeta redonda en porcelana
Porzellanbehälter, rund

	Ø Cm	Ø In
305 21 52 559	40	15,3/4



Inserto scaldavivande tondo in porcellana

Food pan half round chafing dish, porcelain with divider
Bac double en porcelaine pour chafing dish rond
Cubeta en porcelana para chafing dish redondo
Porzellaninsert, 2tlg für chafing dish rund

	Ø Cm	Ø In
305 21 71 951 (1 Pz.)	40	15,3/4



Portauovo per scaldavivande tondo in porcellana

Egg holder for round chafing dish, porcelain
Porte-oeufs en porcelaine pour chafing dish rond
Porta huevos en porcelana para chafing dish redondo
Porzellanereinsatz für chafing dish rund

	Cm	Ø In
305 21 71 950	40	15,3/4



Set zuppiere per scaldavivande tondo Cm 40

Soup tureen set for Cm 40 round chafing dish
Set de soupières pour chafing dish rond Cm 40
Set de soperas para chafing dish redondo Cm 40
Suppenchüsselset für Chafing Dish rund Ø Cm 40

	Ø Cm	Ø In
305 05 52 627 Adattatore - Adapter	40	15,3/4
	Lt	Oz
305 05 15 796 Zuppiera - Souptureen	4,2	142





Aqva



Distributore bevande riscaldato

Heated beverage dispenser
Distributeur de boissons chauffé
Dispensador de bebidas calentado
Getränkspender, aufgewärmt

	Lt	Oz	H Cm.	H In
305 05 52 708	5	169	80	31,1/2



Samovar riscaldato

Heated Samovar
Samovar chauffé
Samovar calentado
Samovar aufgewärmt

	Lt	Oz
305 05 52 707	5 + 1	169 + 35

Teiera in vetro / Glass teapot

305 08 02 580	1	35
---------------	---	----



- 1 Regolatore di temperatura (dai 45°C ai 95°C)
Temperature regulator (from 45°C to 95°C)
- 2 Tasto ON - OFF
ON-OFF button
- 3 Spie luminose/Spie lumineuse:
 - temperatura resistenza >80°C
temperature of the resistance is > di 80°
 - il livello del liquido è sotto al minimo
level of liquid is below minimum
 - lampeggiante - il liquido è in fase di riscaldamento
flashing: the liquid heating up
 - fisso - il liquido ha raggiunto la temperatura desiderata
fi x ed: it has reached the temperature set on the control knob

Distributore Aqva con base in marmo di Carrara

Aqva dispenser with Carrara marble stand

Distributeur Aqva avec support en Carrara marbre

Dispensador Aqva con soporte en Carrara mármol

Getränkspender Aqva mit Ständer aus Carrara Marmor

Marmo di Carrara e vetro - Carrara Marble and glass

	H Cm	H In
305 54 52 729	63	24.8

Il nostro **AQVA** è innovativo, per il suo design elegante ed originale e perché permette, grazie alla doppia parete, di avere una lentissima dispersione della temperatura del liquido interno.

Our **AQVA** is innovative for having an elegant and original design and because it allows, thanks to the double wall, to have an extremely low temperature dispersion of the inside liquid.



FREDDO

Mantenimento della temperatura delle bevande per 5/6 ore senza bisogno di fonti refrigeranti. Test effettuati ad una temperatura ambiente di 20°C (68°F)

COLD

Maintenance of drinks temperature for 5/6 hours without cooling element. Test carried out at 20°C (68°F) room temperature.

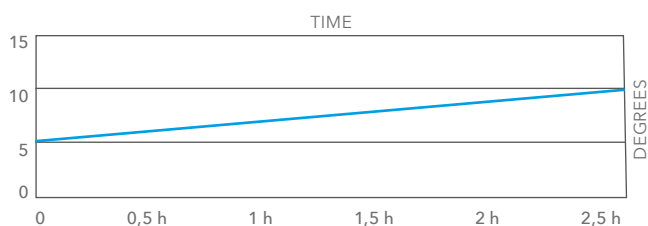

CALDO

Mantenimento della temperatura della bevanda per 4/5 ore senza bisogno di fonti di calore

HOT

Maintenance of drinks temperature for 4/5 hours without heating element.

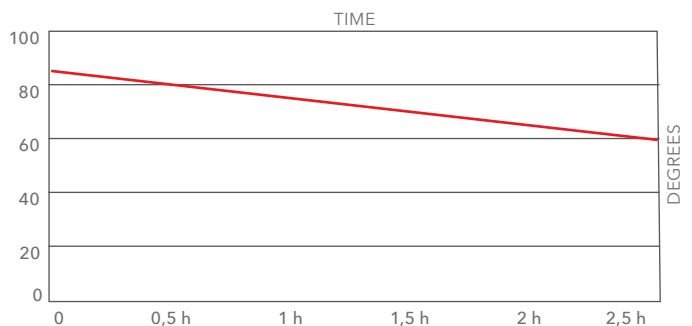

Distributore Aqva con alzata Nature

Aqva dispenser with Nature stand
 Distributeur Aqva avec support Nature
 Dispensador Aqva con soporte Nature
 Aqua Getränkespender mit Ständer Nature

	Cm	H Cm	In	H in
305 44 52 711 nero/black	26 x 26	38	10,1/4 x 10,1/4	31,1/2
305 05 52 711 cromato/chromed	26 x 26	38	10,1/4 x 10,1/4	31,1/2



Distributore Aqva con base in noce

Aqva dispenser with walnut wood stand
 Distributeur Aqva avec support en bois de noyer
 Dispensador Aqva con soporte en madera de nogal
 Getränkespender Aqva mit Ständer aus Walnussholz
 Noce e vetro - Walnut and glass

	H Cm	H In
305 54 52 728	63	24.8





Distributore Aqva con alzata Classica

Aqva dispenser with Classica stand
 Distributeur Aqva avec support Classica
 Dispensador Aqva con soporte Classica
 Aqua Getränkespender mit Ständer Classica

	Ø Cm	H Cm	Ø In	H in
305 55 52 712	27	80	10,5/8	31,1/2

cromato/chromed

305 07 52 712	27	80	10,5/8	31,1/2
---------------	----	----	--------	--------

acciaio argentato/electro-plated stainless steel (EPSS)



Distributore bevande caldo/freddo

Hot and cold beverage dispenser
 Distributeur de boissons chaud/froid
 Dispensador de bebidas caliente/frío
 Getränkespender warm/kalt

	Lt	Oz	H Cm.	H In
305 05 52 709	5	169	80	31,1/2



Gennaro



Espositore piccola pasticceria

Petits fours display
 Présentoir à petits fours
 Soporte para pasteles
 Ständer für kleine Gebäcke



	Ø mm	H mm	Ø In	H In	Fori/holes
607 N0 71 933	490	423	19,1/4	16,1/2	60
607 P0 68 115	340	300	13,3/8	11,3/4	32
607 P0 68 117	165	145	6,1/2	6,1/2	9

Paletta pasticceria Acciaio Inox

Server for petit fours small St.Steel
 Petite pelle à petits fours Acier Inox
 Pala pequeña para pastelitos Acero Inox
 Gebäckzange, Edelstahl

	Cm	In
3050581708	5	2
3050581711 con piega	3,7 x 9	1,5/8 x 3,1/2







Italo

Cottura - Cooking



Mantenimento del calore - Heat-keeping





Piano a induzione con supporto in acciaio

Induction cooktop with steel countertop
 Plaque à induction avec table de travail en acier
 Placa de inducción con encimera en acero
 Induktionskochplatte mit Arbeitsplatte Edelstahl

	Cm	In
305 05 52 725	30 x 38,5	23,5/8 x 15,1/8

Compenso in acciaio

Steel countertop
 Table de travail en acier
 Encimera en acero
 Arbeitsplatte Edelstahl

	Cm	In
305 05 52 727	30 x 38,5	11,3/4 x 15,1/8

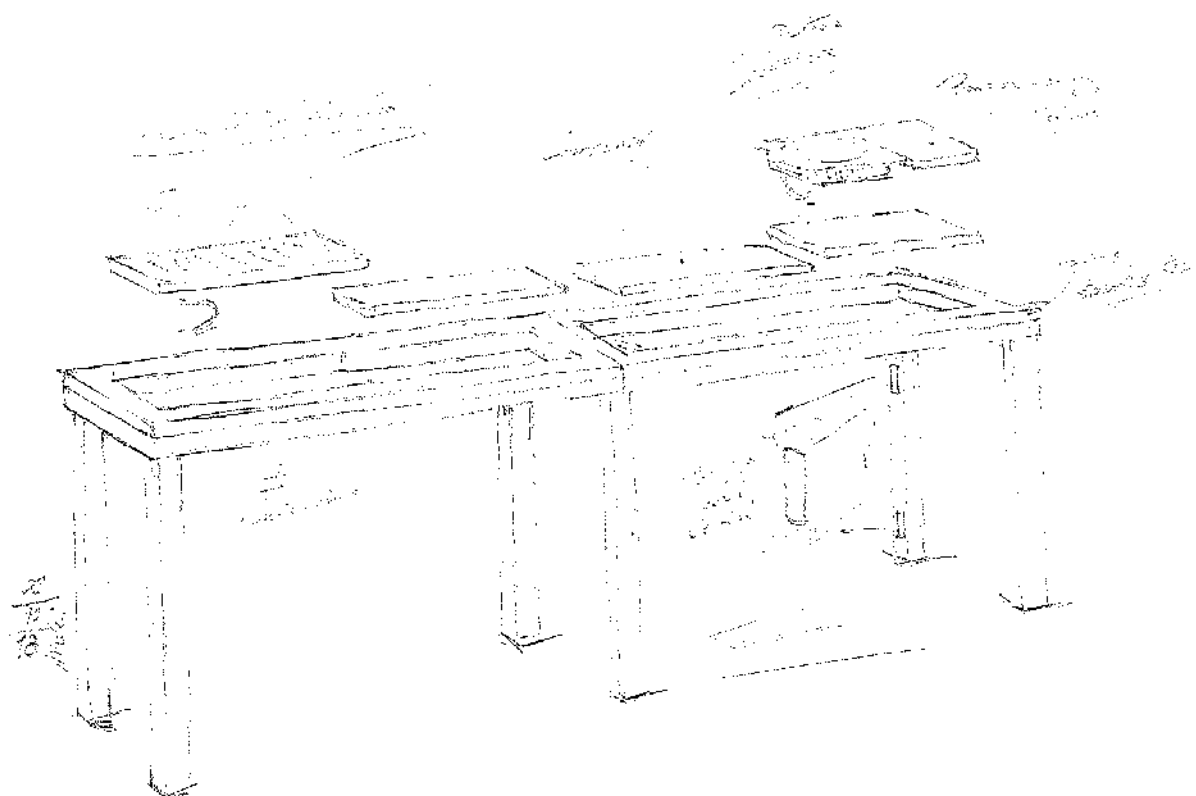



Scaldavivande da incasso con coperchio in acciaio inox

Built-in chafing dish with St. Steel cover
Chafing dish encastrable avec couvercle en acier inox
Chafing dish para empotrar con tapa en acero inox
Chafing Dish zum Einbauen mit Edelstahl Deckel

	Cm	H Cm
GN 1/1		
305 05 52 693	60,5 x 40,5	39,5

Refrigerato / Thermal

GN 1/1		
305 05 52 706	60,5 x 40,5	39,5

Scaldavivande da incasso con coperchio in acciaio inox /vetro

Built-in chafing dish with St. Steel / glass cover
Chafing dish encastrable avec couvercle en acier inox / verre
Chafing dish para empotrar con tapa en acero inox / vidrio
Chafing Dish zum Einbauen mit Edelstahl / Glass Deckel

	Cm	H Cm
GN 1/1		
305 05 52 692	60,5 x 40	39,5

Refrigerato / Thermal

GN 1/1		
305 05 52 705	60,5 x 40	39,5

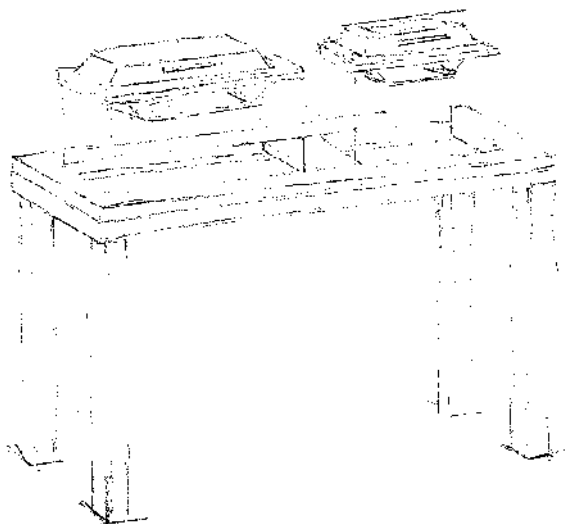



**Scaldavivande da incasso
con coperchio in acciaio inox**

Built-in chafing dish with St. Steel cover
Chafing dish encastrable avec couvercle en acier inox
Chafing dish para empotrar con tapa en acero inox
Chafing Dish zum Einbauen mit Edelstahl Deckel

	Cm	H Cm
GN 2/3		
305 05 52 695	43 x 40	21

**Scaldavivande da incasso
con coperchio in acciaio inox / vetro**

Built-in chafing dish with St. Steel / glass cover
Chafing dish encastrable avec couvercle en acier inox / verre
Chafing dish para empotrar con tapa en acero inox / vidrio
Chafing Dish zum Einbauen mit Edelstahl / Glass Deckel

	Cm	H Cm
GN 2/3		
305 05 52 694	43 x 40	21

Compenso GN 1/3 in laminato

GN 1/3 countertop laminate
Table de travail GN 1/3 en melamine
Encimera GN 1/3 en laminado
Arbeitsplatte GN 1/3

	Cm	In
■ 305 04 51 709	17,6 x 32,5	6,7/8 x 12,3/4





Caratterizzato da un design pulito

e funzionale che lo rende simile a un mobile contemporaneo, il carrello Italo può essere utilizzato come comodo sostegno e mezzo di trasporto per i tavoli opportunamente piegati.

It stands out with a simple design;

trolley Italo can be used as a useful support, as well as a carriage of the tables properly folded.

Il carrello è dotato di 3 scaffali

nei quali riporre i prodotti che successivamente verranno disposti sul tavolo. Una volta svuotato, può essere trasformato in un mobile nel quale collocare ordinatamente le stoviglie; può inoltre essere utilizzato come piano di appoggio aggiuntivo al tavolo. Composto da materiali pregiati: acciaio e legno. È inoltre dotato di 4 ruote in acciaio pivotanti e con freno.

Misure: 115 x 59 x H 89 Cm

The trolley contains accommodations and

sections where one can store the products which, after that, will be placed on the table. Once empty, taking off the dividers, it can be transformed in a piece of furniture in which it is possible to store tableware tidily; also, it can be used as an additional countertop besides the table. Made of high-quality materials: steel and wood.

Size: 115 x 59 x H 89 Cm



Carrello

Trolley
Chariot
Carro
Wagen

	Cm	In
■ 305 04 52 647	115 x 59 H. 89	6,7/8 x 12,3/4



Tavolo 1

Table 1
Table 1
Mesa 1
Tisch 1

	Cm	H Cm	In	H In
■ 305 04 51 651	132 x 65	89	52 x 25,5	35



Tavolo 2

Table 2
Table 2
Mesa 2
Tisch 2

	Cm	H Cm	In	H In
■ 305 04 51 652	264 x 65	89	104 x 25,5	35

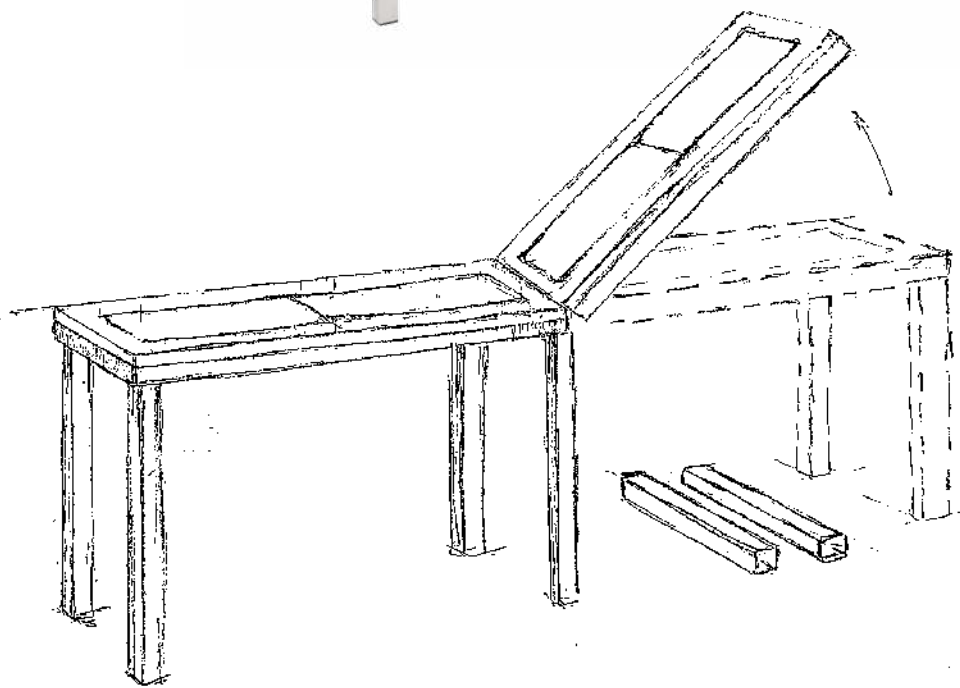

Ogni tavolo È dotato di due compensi in legno removibili, ciascuno dei quali misura 60 x 38,5Cm, in modo da poter allocare all'interno dei tavoli i seguenti accessori:

Cahafing dish gn 2/3 + compenso legno
 Cahafing dish gn 1/1
 Piano ad induzione
 Piano per il mantenimento del calore

Each table has two removable wood countertops, whose size is 60 x 38,5 Cm, so that inside the tables the following accessories can be fitted:

*GN 2/3 chafing dish+ wood countertop
 GN 1/1 chafing dish
 Induction cooktop
 Top, heat-keeping*



Possibilita' di avere una o piu' gambe del tavolo adatte a nascondere i cavi elettrici. Tutte le gambe dei tavoli hanno un aggancio semplificato (attraverso due perni facilmente avvitalibili senza alcun utensile).

Possibility of having one or more table legs, suitable for hiding the electric cables. All the table legs have a simple coupling (by two pivots, easily screwable by hand).

Gamba elettrificata su richiesta

Electric leg
 Jambe électrique
 Pata eléctrica
 Elektrische Beine

B35 05 51 652





1818

ABERT S.p.A.
Divisione Broggi 1818

Via Don P. Mazzolari, 17 25050 Passirano (BS) Italy

T. +39 030 6853601-602
F. +39 030 6853610
info@broggi.it