



Broggi 1818

Buffet 2023





Decò

Cubo Decò

Decò cube
Cube Decò
Cubo Decò
Decò Würfel

ACCIAIO - St. steel

	base Cm	H Cm	base in.	H in.
326 05 42 001	15 x 15	15,0	5,9 x 5,9	5,9
326 05 42 002	20 x 20	20,0	7,9 x 7,9	7,9
326 05 42 003	25 x 25	25,0	9,8 x 9,8	9,8

ACCIAIO DORATO - Gilded st. steel

	base Cm	H Cm	base in.	H in.
326 28 42 001	15 x 15	15,0	5,9 x 5,9	5,9
326 28 42 002	20 x 20	20,0	7,9 x 7,9	7,9
326 28 42 003	25 x 25	25,0	9,8 x 9,8	9,8

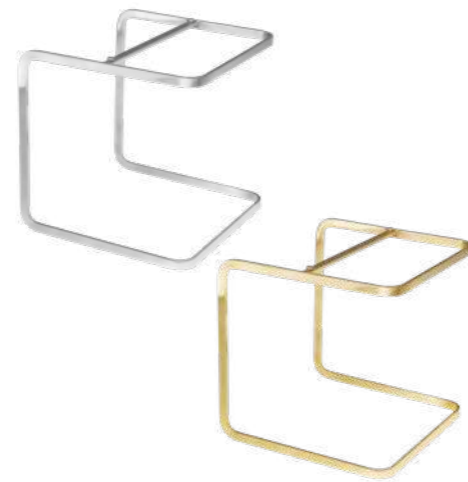
**Cilindro Decò**

Decò cylinder
Cylindre Decò
Cilindro Decò
Decò Zylinder

ACCIAIO - St. steel

	base Ø Cm	H Cm	base Ø in.	H in.
326 05 42 004	20	15	7,9	5,9
326 05 42 005	20	25	7,9	9,8

ACCIAIO DORATO - Gilded st. steel

	base Ø Cm	H Cm	base Ø in.	H in.
326 28 42 004	20	15	7,9	5,9
326 28 42 005	20	25	7,9	9,8

**Piano Decò, quadrato**

Decò top, square
Dessus Decò carré
Tablero Decò cuadrado
Platte Decò quadrat

MARMO DI CARRARA - Carrara marble

	base Cm	H Cm	base in.	H in.
326 22 42 001	15 x 15	1,2	5,9 x 5,9	0,5
326 22 42 002	20 x 20	1,2	7,9 x 7,9	0,5
326 22 42 003	25 x 25	1,2	9,8 x 9,8	0,5

HPL

	base Cm	H Cm	base in.	H in.
326 64 42 001	15 x 15	1,2	5,9 x 5,9	0,5
326 64 42 002	20 x 20	1,2	7,9 x 7,9	0,5
326 64 42 003	25 x 25	1,2	9,8 x 9,8	0,5

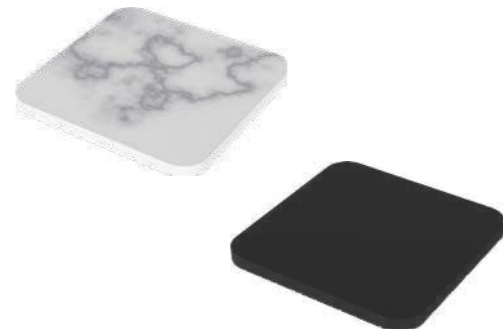
**Piano Decò, tondo**

Decò top, square
Dessus Decò ronde
Tablero Decò redondo
Platte Decò runden

MARMO DI CARRARA - Carrara marble

	base Ø Cm	H Cm	base in.	H in.
326 22 42 007	15	1,2	5,9	0,5
326 22 42 008	19	1,2	7 1/2	0,5
326 22 42 009	20	1,2	7,9	0,5

HPL

	base Ø Cm	H Cm	base in.	H in.
326 64 42 007	15	1,2	5,9	0,5
326 64 42 008	19	1,2	7 1/2	0,5
326 64 42 009	20	1,2	7,9	0,5

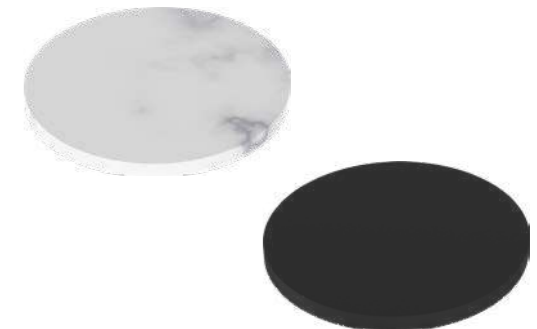
**Piano Decò, rettangolare**

Decò top, rectangular
Dessus Decò rectangulaire
Tablero Decò rectangular
Platte Decò rechteckig

MARMO DI CARRARA - Carrara marble

	base Cm	H Cm	base in.	H in.
326 22 42 004	15 x 50	1,2	5,9 x 19,7	0,5
326 22 42 005	20 x 60	1,2	7,9 x 23,6	0,5
326 22 42 006	25 x 70	1,2	9,8 x 27,6	0,5

HPL

	base Cm	H Cm	base in.	H in.
326 64 42 004	15 x 50	1,2	5,9 x 19,7	0,5
326 64 42 005	20 x 60	1,2	7,9 x 23,6	0,5
326 64 42 006	25 x 70	1,2	9,8 x 27,6	0,5

**Cestino pane Decò su alzata tonda**

Decò bread basket on round stand
Corbeille à pain Decò sur support rond
Cesta pan Decò sobre soporte redondo
Brotkorb Decò, rund

ACCIAIO - St. steel

	Ø Cm	H Cm	In	H In
326 05 24 010	20	15	7,9	5,9
326 05 24 011	20	25	7,9	9,8

ACCIAIO DORATO - Gilded st. steel

	Ø Cm	H Cm	In	H In
326 28 24 010	20	15	7,9	5,9
326 28 24 011	20	25	7,9	9,8





Distributore vetro doppio corpo

Dispenser, glass, double-wall
 Distributeur verre double parois
 Dispensador cristal doble pared
 Spender, Glas, doppelwandig

ACCIAIO/MARMO - chromed/Marble

	Lt	Oz
326 05 52 003	2,5	84,5

ACCIAIO/HPL - chromed/HPL

	Lt	Oz
326 05 52 004	2,5	84,5

Distributore vetro doppio corpo

Dispenser, glass, double-wall
 Distributeur verre double parois
 Dispensador cristal doble pared
 Spender, Glas, doppelwandig

DORATO/MARMO - gilded/Marble

	Lt	Oz
326 28 52 003	2,5	84,5

DORATO/HPL - gilded/HPL

	Lt	Oz
326 28 52 004	2,5	84,5





Distributore succhi Decò

Decò juice dispenser
 Distributeur de jus Decò
 Dispensador zumo Decò
 Müslispender Decò;

ACCIAIO/MARMO - steel/Marble

	Lt	Oz
326 05 52 005	8	270,5

ACCIAIO/HPL - steel/HPL

	Lt	Oz
326 05 52 006	8	270,5



Distributore succhi Decò

Decò juice dispenser
 Distributeur de jus Decò
 Dispensador zumo Decò
 Müslispender Decò;

ACCIAIO/MARMO - chromed/Marble

	Lt	Oz
326 28 52 005	8	270,5

ACCIAIO DORATO/HPL - gilded steel/HPL

	Lt	Oz
326 28 52 006	8	270,5



Distributore cereali Decò

Decò cereal dispenser
 Distributeur céréales Decò
 Dispensador cereales Decò
 Müslispender Decò

ACCIAIO/MARMO - chromed/Marble

	Lt	Oz
326 05 52 001	3	101

ACCIAIO/HPL - chromed/HPL

	Lt	Oz
326 05 52 002	3	101

**Distributore cereali Decò**

Decò cereal dispenser
 Distributeur céréales Decò
 Dispensador cereales Decò
 Müslispender Decò

DORATO/MARMO - gilded/Marble

	Lt	Oz
326 28 52 001	3	101

DORATO/HPL - gilded/HPL

	Lt	Oz
326 28 52 002	3	101

Distributore caffè Decò

Decò coffee urn
 Distributeur de café
 Dispensador café
 Kaffeespender Decò

ACCIAIO/MARMO - chromed/Marble

	Lt	Oz
326 05 52 007	7	236,7
326 05 52 009	10	338,1

ACCIAIO/HPL - chromed/HPL

	Lt	Oz
326 05 52 008	7	236,7
326 05 52 010	10	338,1

**Distributore caffè Decò**

Decò coffee urn
 Distributeur de café
 Dispensador café
 Kaffeespender Decò

DORATO/MARMO - gilded/Marble

	Lt	Oz
326 28 52 007	7	236,7
326 28 52 009	10	338,1

DORATO/HPL - gilded/HPL

	Lt	Oz
326 28 52 008	7	236,7
326 28 52 010	10	338,1

**Piastra elettrica scalda-caffè**

Coffee-warmer electric plate
 Plaque chauffante électrique à café
 Placa eléctrica calentacafé
 Kaffeewärmer mit elektrischer Platte

305 05 52 576





Vassoio ringhiera Decò in filo di acciaio

Decò tray with railing steel wire
 Plateau Decò avec rambarde en acier
 Bandeja Decò con barandilla en acero
 Platte Decò mit Edelstahlreling

FILO DI ACCIAIO - Railing steel wire

	Cm	H Cm	In	H In
326 05 23 010	40 x 40	7	15,3/4 x 15,3/4	2,3/4
326 05 23 011	60 x 40	7	23,5/8 x 15,3/4	2,3/4

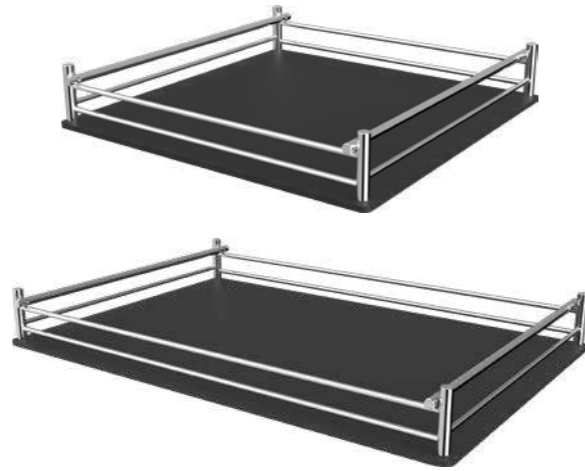
**FILO DI ACCIAIO DORATO - Railing gilded steel wire**

	Cm	H Cm	In	H In
326 28 23 010	40 x 40	7	15,3/4 x 15,3/4	2,3/4
326 28 23 011	60 x 40	7	23,5/8 x 15,3/4	2,3/4

**FILO DI ACCIAIO CON PANNO - Steel wire railing and fabric**

	Cm	H Cm	In	H In
326 05 23 012	60 x 40	7	23,5/8 x 15,3/4	2,3/4

**FILO DI ACCIAIO DORATO CON PANNO
Gilded steel wire railing and fabric**

	Cm	H Cm	In	H In
326 28 23 012	60 x 40	7	23,5/8 x 15,3/4	2,3/4

**Portacaraffe Decò refrigerato**

Decò jug stand, refrigerated
 Support pour carafes Decò réfrigéré
 Soporte para jarras Decò refrigerado
 Flaschenhalter Decò, gekühlt

ACCIAIO - St. steel

	Cm	H Cm	In	H In
326 05 24 001	52,5 x 20	9	20,5/8 x 7,7/8	3,1/2

ACCIAIO DORATO - Gilded st. steel

	Cm	H Cm	In	H In
326 28 24 001	52,5 x 20	9	20,5/8 x 7,7/8	3,1/2

**Barella Decò**

Tray
 Plateau
 Bandeja
 Tablett

CON PIANO IN HPL - HPL top

	Cm	H Cm	In	H In
326 05 23 001	52,5 x 20	5	20,5/8 x 7,7/8	2

CON PIANO IN HPL DORATO - HPL top, gilded

	Cm	H Cm	In	H In
326 28 23 001	52,5 x 20	5	20,5/8 x 7,7/8	2



Supporto alto per ciotole

bowl stand, high
Support pour bols haut
Soporte para boles alto
Schüsselständer, hoch

ACCIAIO - St.steel

	Cm	H Cm	In	H In
326 05 42 011	52,5 x 20	20	20,5/8 x 7,7/8	7,7/8

ACCIAIO DORATO - Gilded st.steel

	Cm	H Cm	In	H In
326 28 42 011	52,5 x 20	20	20,5/8 x 7,7/8	7,7/8

Ciotole artesano o ciotole urban non incluse
Artesano bowls or urban bowls not included



Supporto alto per vasi

Jar stand, hig
Support pour pots en verre haut
Soporte para jarrones de cristal alto
Glasständer, hoch

ACCIAIO - St.steel

	Cm	H Cm	In	H In
326 05 42 010	52,5 x 20	20	20,5/8 x 7,7/8	7,7/8

ACCIAIO DORATO - Gilded st.steel

	Cm	H Cm	In	H In
326 28 42 010	52,5 x 20	20	20,5/8 x 7,7/8	7,7/8

Vasi in vetro non incluso / Glass jars with lid not included



Supporto medio per ciotole

bowl stand, medium
Support pour bols moyen
Soporte para boles mediano
Schüsselständer, mittel

ACCIAIO - St.steel

	Cm	H Cm	In	H In
326 05 42 013	52,5 x 20	13,5	20,5/8 x 7,7/8	5,3/8

ACCIAIO DORATO - Gilded st.steel

	Cm	H Cm	In	H In
326 28 42 013	52,5 x 20	13,5	20,5/8 x 7,7/8	5,3/8

Ciotole artesano o ciotole urban non incluse
Artesano bowls or urban bowls not included



Supporto medio per vasi

Jar stand, medium
Support pour pots en verre moyen
Soporte para jarrones de cristal mediano
Glasständer, mittel

ACCIAIO - St.steel

	Cm	H Cm	In	H In
326 05 42 012	52,5 x 20	13,5	20,5/8 x 7,7/8	5,3/8

ACCIAIO DORATO - Gilded st.steel

	Cm	H Cm	In	H In
326 28 42 012	52,5 x 20	13,5	20,5/8 x 7,7/8	5,3/8

Vasi in vetro non incluso / Glass jars with lid not included





Alzata scaffale Decò 2 piani

Decò 2-shelf stand

Étagère Decò 2 étages

Estante Decò 2 estantes Regalständer

Decò mit 2 Böden

ACCIAIO/HPL - Chromed/hpl

	Cm	H Cm	In	H In
326 05 42 020	15 x 50	25,5	6 x 19,7/8	10
326 05 42 021	20 x 60	25,5	7,7/8 x 23 5/8	10

**ACCIAIO/MARMO - Chromed/marble**

	Cm	H Cm	In	H In
326 05 42 022	15 x 50	25,5	6 x 19,7/8	10
326 05 42 023	20 x 60	25,5	7,7/8 x 23 5/8	10

**DORATO/HPL - Gilded/hpl**

	Cm	H Cm	In	H In
326 28 42 020	15 x 50	25,5	6 x 19,7/8	10
326 28 42 021	20 x 60	25,5	7,7/8 x 23 5/8	10

**DORATO/MARMO - gilded/marble**

	Cm	H Cm	In	H In
326 28 42 022	15 x 50	25,5	6 x 19,7/8	10
326 28 42 023	20 x 60	25,5	7,7/8 x 23 5/8	10

**Portaformaggi refrigerato Decò con bascula**

Decò cheese dish, thermal with roll-top cover

Plateau à fromage réfrigéré Decò avec bascule

Porta queso refrigerado Decò con bascula

Käseplatte Decò, gekühlt mit Rolltop-Cover,

ACCIAIO - St.steel

	Cm	In
326 05 54 002	52 x 32	20,1/2 x 12,5/8

ACCIAIO DORATO - Gilded st.steel

	Cm	In
326 28 54 002	52 x 32	20,1/2 x 12,5/8

**Vassoio formaggi refrigerato Decò**

Decò cheese tray, thermal

Plateau à fromage réfrigéré Decò

Bandeja queso refrigerado Decò

Käseplatte Decò, gekühlt

ACCIAIO - St.steel

	Cm	In
326 05 54 001	52 x 32	20,1/2 x 12,5/8

ACCIAIO DORATO - Gilded st.steel

	Cm	In
326 28 54 001	52 x 32	20,1/2 x 12,5/8



Nature Buffet



Alzata torta in noce bassa

Cake stand, walnut
Présentoir à gâteau x en bois de noyer
Presentación tarta en madera de nogal
Tortenplatte Walnussholz

Noce - Walnut

	Ø Cm	Ø In	H Cm	H In
305 54 42 673 (small)	28	11	14	5,5
305 54 42 674 (medium)	33	12,9	14	5,5
305 54 42 675 (large)	37	14,5	14	5,5



Alzata torta in noce alta

Cake stand, walnut
Présentoir à gâteau x en bois de noyer
Presentación tarta en madera de nogal
Tortenplatte Walnussholz

Noce - Walnut

	Ø Cm	Ø In	H Cm	H In
305 54 42 676 (small)	28	11	21	8,2
305 54 42 677 (medium)	33	12,9	21	8,2
305 54 42 678 (large)	37	14,5	21	8,2



**Coperchio a bascula
 adatto per alzate Ø37Cm
 suitable for stands Ø37Cm**

Transparent round rolltop cover
Cloche basculante ronde transparente
Rolltophaube - rund
Campana redonda transparente

SAN

	Ø Cm	Ø In
V76 12 15 T01	34	13,3/8



**Cupola in vetro
 adatto per alzate Ø28Cm
 suitable for stands Ø28Cm**

Dome cover, glass
Cloche en verre
Campana de vidrio
Cloche aus Glas

Vetro - Glass

	Ø Cm	Ø In
404 10 42 610	25	9,8



**Cupola in policarbonato
 adatto per alzate Ø28Cm
 suitable for stands Ø28Cm**

Dome cover, acrylic
Cloche en acrylique
Campana de acrílico
Cloche aus Polycarbonat

Polycarbonato - Polycarbonat

	Ø Cm	Ø In
305 12 53 625	26	10,2



Alzata pasticceria Noce

Cake stand, walnut
Présentoir à gâteau x en bois de noyer
Soporte pasteles en madera de nogal
Tortenplatte Walnussholz

Noce - Walnut

	Ø Cm	H Cm	Ø In	H In
305 54 42 692	16	9 Cm	6,1/4	3,1/2



Alzata pasticceria 2 piani

Petit fours stand
Plat à petits fours sur pied
Petit Four Stand
Soporte pasteles

Noce - Walnut

	H Cm	H In
305 54 42 671 (2 posti)	23,5 x 24,4	12



Alzata pasticceria 3 piani

Petit fours stand
Plat à petits fours sur pied
Petit Four Stand
Soporte pasteles

Noce - Walnut

	H Cm	H In
305 54 42 670 (3 posti)	43 x 41,5	12



Piattino rettangolare

Rectangular plate - Plato rectangular
Plat rectangulaire - Rechteckige Teeller
Porcellana - Porcelain

	Cm	In
264 00 42 669	18 x 11	7 x 4,3



Piattino quadrato porcellana

Square saucer - Platillo cuadrado
Soucoupe carrée - Quadratische teller
Porcellana - Porcelain

	Cm	In
322 21 22 691	10 x 10	3,9 x 3,9



Ciotolina a goccia

Bowl - Bol
Bol - Schüssel
Porcellana - Porcelain

	Cm	In
V87 21 42 001	8 x 7 x 4	3,1 x 1,5



Coppetta rotonda

Round bowl - Bol redondo
Bol rond - Runde Schüssel
Porcellana - Porcelain

	Ø Cm	Ø In
V87 21 42 005	7	2,7



Distributore Aqva con alzata Nature

Aqva dispenser with Nature stand
Distributeur Aqva avec support Nature
Dispensador Aqva con soporte Nature
Aqua Getränkespender mit Ständer Nature

	Cm	In	H Cm	H In
305 44 52 711	26 x 26	38	10,1/4 x 10,1/4	31,1/2
nero/black				
305 05 52 711	26 x 26	38	10,1/4 x 10,1/4	31,1/2
cromato/chromed				

Distributore Aqva con base in noce

Aqva dispenser with walnut wood stand
Distributeur Aqva avec support en bois de noyer
Dispensador Aqva con soporte en madera de nogal
Getränkespender Aqva mit Ständer aus Walnussholz

Noce e vetro - Walnut and glass

	H Cm	H In
305 54 52 728	63	24.8







Piano in noce massello

Solid walnut wood top
 Dessus en bois massif noyer
 Tabla de madera maciza de nogal
 Top Walnuss massiv

	Cm	In
305 54 42 629	30 x 30	11,3/4 x 11,3/4
305 54 42 630	70 x 30	27,1/2 x 11,3/4
305 54 42 631	100 x 30	39,3/8 x 11,3/4



Piano in ardesia

Slate top
 Dessus en ardoise
 Tabla de pizarra
 Top Schiefer

	Cm	In
V87 09 42 Q01	30 x 30	11,3/4 x 11,3/4
V87 09 42 R01	70 x 30	27,1/2 x 11,3/4
V87 09 42 R02	100 x 30	39,3/8 x 11,3/4



Piano in pietra lavica

Lava top
 Dessus en pierre de lave
 Tabla de piedra lávica
 Top Lavastein

	Cm	In
305 60 42 633	30 x 30	11,3/4 x 11,3/4
305 60 42 634	70 x 30	27,1/2 x 11,3/4
305 60 42 635	100 x 30	39,3/8 x 11,3/4



Vassoio per alzate rettangolare

Tray for podia, rectangular
 Plateau pour supports rectangulaire
 Bandeja rectangular para soportes
 Tablett Walnuss, rechtekig

	Cm	H Cm	In	H In
305 54 23 854	35 x 52,5	4,5	13,3/4 x 20,5/8	1,3/4



Vassoio per alzate rettangolare

Tray for podia, rectangular
 Plateau pour supports rectangulaire
 Bandeja rectangular para soportes
 Tablett Walnuss, rechtekig

	Cm	H Cm	In	H In
305 54 23 855	35 x 52,5	8	13,3/4 x 20,5/8	3,1/8



Vassoio per alzate rettangolare

Tray for podia, rectangular
 Plateau pour supports rectangulaire
 Bandeja rectangular para soportes
 Tablett Walnuss, rechtekig

	Cm	H Cm	In	H In
305 54 23 853	17,5 x 52,5	4,5	6,7/8 x 20,5/8	1,3/4



Vassoio alzata Nature in legno

Nature tray, walnut wood
 Plateau Nature en bois noyer
 Bandeja Nature en madera de nogal
 Tablett Walnuss rechteckig

	Cm	H Cm	In	H In
305 54 23 886	26 x 35	4,5	10,2 x 13,8	1,3/4



Base inclinata per vassoio

Inclined base for rectangular trays
 Base inclinée pour plateau x rectangulair
 Base inclinada para bandejas
 Basistablett mit Kante rechteckig

	Cm	H Cm	In	H In
305 54 23 856	35 x 52,5	6,7	13,3/4 x 20,5/8	2,1/2



Alzata quadrata nera opaca

Square podium
Support carré
Soporte cuadrado
Podest quadratisch

NERA OPACA - matte black

	Cm	H Cm	In	H In
305 44 42 621	18 x 18	20	7 x 7	7,7/8
305 44 42 622	18 x 18	25	7 x 7	9,7/8
305 44 42 623	18 x 18	30	7 x 7	11,3/4

CROMATA - cromed

	Cm	H Cm	In	H In
305 05 42 621	18 x 18	20	7 x 7	7,7/8
305 05 42 622	18 x 18	25	7 x 7	9,7/8
305 05 42 623	18 x 18	30	7 x 7	11,3/4



Alzata rettangolare

Rectangular podium
Support rectangulaire
Soporte rectangular
Podest rechteckig

NERA OPACA - matte black

	Cm	H Cm	In	H In
305 44 42 625	17,5 x 52,5	13,5	6,7/8 x 20,5/8	5,3/4
305 44 42 626	17,5 x 52,5	20	6,7/8 x 20,5/8	7,7/8

CROMATA - cromed

	Cm	H Cm	In	H In
305 05 42 625	17,5 x 52,5	13,5	6,7/8 x 20,5/8	5,3/4
305 05 42 626	17,5 x 52,5	20	6,7/8 x 20,5/8	7,7/8



Alzata rettangolare

Rectangular podium
Support rectangulaire
Soporte rectangular
Podest rechteckig

NERA OPACA - matte black

	Cm	H Cm	In	H In
305 44 42 627	35 x 52,5	13,5	13,3/4 x 20,5/8	5,3/4
305 44 42 628	35 x 52,5	20	13,3/4 x 20,5/8	7,7/8

CROMATA - cromed

	Cm	H Cm	In	H In
305 05 42 627	35 x 52,5	13,5	13,3/4 x 20,5/8	5,3/4
305 05 42 628	35 x 52,5	20	13,3/4 x 20,5/8	7,7/8

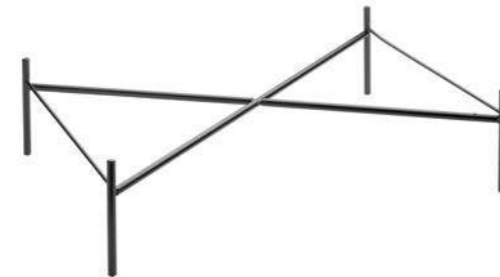

Alzata rettangolare per porcellane

Rectangular podium for porcelain items
Support rectangulaire pour articles en porcelaine
Soporte rectangular para artículos de porcelana
Podest rechteckig für Artikel aus Porzellan

NERA OPACA - matte black

	Cm	H Cm	In	H
305 44 42 624	12 x 40	13,5	4,3/4 x 15,3/4	5,3/4
305 44 42 632	12 x 40	20	4,3/4 x 15,3/4	7,7/8

CROMATA - cromed

	Cm	H Cm	In	H
305 05 42 624	12 x 40	13,5	4,3/4 x 15,3/4	5,3/4
305 05 42 632	12 x 40	20	4,3/4 x 15,3/4	7,7/8



Cestino pane per alzata quadrata

Bread basket for square podium
Corbeille à pain pour support carré
Cesta para pan para soporte cuadrado
Brotkorb für Podium quadratisch

Misto lino - Linen blend

	Cm	H Cm	In	H In
305 29 24 588	18 x 18	20	7 x 7	7,7/8



Alzata quadrata nera opaca

Matte black square podium
Support carré noir
Soporte cuadrado negro mate
Podest quadratisch Schwarz

	Cm	H Cm	In	H In
305 44 42 621	18 x 18	20	7 x 7	7,7/8
305 44 42 622	18 x 18	25	7 x 7	9,7/8
305 44 42 623	18 x 18	30	7 x 7	11,3/4



Cestino pane per alzata rettangolare

Bread basket for rectangular podium
Corbeille à pain pour support rectangulaire
Cesta para pan para soporte rectangular
Brotkorb für Podium rechteckig Cm

Misto lino - Linen blend

	Cm	H Cm	In	H In
305 29 24 589	17,5 x 52,5	13,5	6,7/8 x 20,5/8	5,3/4
305 29 24 590	17,5 x 52,5	20	6,7/8 x 20,5/8	7,7/8



Alzata rettangolare nera opaca

Matte black rectangular podium
Support rectangulaire noir
Soporte rectangular negro mate
Podest rechteckig Schwarz

	Cm	H Cm	In	H In
305 44 42 625	17,5 x 52,5	13,5	6,7/8 x 20,5/8	5,3/4
305 44 42 626	17,5 x 52,5	20	6,7/8 x 20,5/8	7,7/8





Base in legno con 3 fori

Wood base with 3 holes
 Base en bois avec 3 trous
 Base de madera con 3 agujeros
 Holzbasis mit 3 runden Ausschnitten

Noce - Walnut

	Cm	H Cm	In	H In
305 54 54 609	17,5 x 52,5	2,5	6,7/8 x 20,5/8	1



Vaso in vetro con coperchio

Glass jar with lid
 Pot en verre avec couvercle
 Jarrón de vidrio con tapa
 Glasdose mit Deckel

Vetro - Glass

	Ø Cm	H Cm	In	H In
404 10 31 304	14	17,5	5,1/2	6,7/8
404 10 31 305	14	23	5,1/2	9
404 10 31 306	14	29,5	5,1/2	11,5/8



Base legno per 3 ciotole in porcellana

Wood base fitting 3 porcelain bowls
 Base en bois pour 3 bols en porcelaine
 Base de madera para 3 boles de porcelana
 Holzbasis für 3 Porzellan Bols

Noce - Walnut

	Cm	H Cm	In	H In
305 54 54 608	17,5 x 52,5	2,5	6,7/8 x 20,5/8	1



Coppetta affinity

Affinity bowl
 Bol Affinity
 Bol Affinity
 Affinity Bol

Porcellana - Porcelain

	Ø Cm	Ø In
264 00 43 800	15	6



Ciotola Artesano

Artesano bowl
 Bol Artesano
 Bol Artesano
 Artesano bol

Porcellana - Porcelain

	Lt	Oz
264 02 51 900	0,6	21



Coperchio per coppetta in vetro

Lid for glass bowl
 Couvercle pour bol en verre
 Tapa para bol de vidrio
 Deckel für Glasschale

Inox 18/10 - St. Steel

	Ø Cm	Ø In
B01 12 52 640	15	6



Ciotola Urban

Urban bowl
 Bol Urban
 Bol Urban
 Urban bol

Porcellana - Porcelain

	Lt	Oz
263 45 21 900	0,6	21



Coppetta in vetro

Glass bowl
 Bol en verre
 Bol de vidrio
 Glasschale

Vetro - Glass

	Ø Cm	Ø In
V76 08 52 004	15	6





Piatto ovale Artesano

Artesano oval bowl
Coupe ovale Artesano
Plato oval Artesano
Artesano Schale oval

Porcellana - Porcelain

	Cm	In
264 02 53 844	55 x 17	21,5/8 x 6,3/4



Insalatiera Artesano

Artesano salad bowl
Saladier Artesano
Ensaladera Artesano
Artesano Schüssel rund

Porcellana - Porcelain

	Ø Cm	Ø In
264 02 53 170	28	11



Piatto presentazione Artesano

Artesano presentation bowl
Coupe présentation Artesano
Plato presentación Artesano
Artesano Präsentationsschale rund

Porcellana - Porcelain

	Ø Cm	Ø In
264 02 53 760	37	14,1/2



Alzata rettangolare per porcellane

Rectangular podium for porcelain items
Support rectangulaire pour articles en porcelaine
Soporte rectangular para artículos de porcelana
Podest rechteckig für Artikel aus Porzellan

Nero opaco - Matte black

	Cm	H Cm	In	H
305 44 42 624	12 x 40	13,5	4,3/4 x 15,3/4	5,3/4
305 44 42 632	12 x 40	20	4,3/4 x 15,3/4	7,7/8

Cromato - Chromed

	Cm	H Cm	In	H
305 05 42 624	12 x 40	13,5	4,3/4 x 15,3/4	5,3/4
305 05 42 632	12 x 40	20	4,3/4 x 15,3/4	7,7/8



Alzata quadrata

Square podium
Support carré
Soporte cuadrado
Podest quadratisch

Nero opaco - Matte black

	Cm	H Cm	In	H In
305 44 42 621	18 x 18	20	7 x 7	7,7/8
305 44 42 622	18 x 18	25	7 x 7	9,7/8
305 44 42 623	18 x 18	30	7 x 7	11,3/4

Cromato - Chromed

	Cm	H Cm	In	H In
305 05 42 621	18 x 18	20	7 x 7	7,7/8
305 05 42 622	18 x 18	25	7 x 7	9,7/8
305 05 42 623	18 x 18	30	7 x 7	11,3/4







Secchio champagne

Champagne bucket
Seau à champagne
Cubo champàn
Champagnerkühler

Tiglio - Lime wood

	Ø Cm	Ø In
305 54 43 628	20	7,7/8



Coppa punch

Punch bucket
Bol à punch
Champañera
Punch Bol mit Einsatz

Tiglio - Lime wood

	Ø Cm	Ø In
305 54 43 629	40	15,3/4



Tagliere con cinghia acciaio

Cutting board with st. steel belt
Planche à découper
Tabla de cortar con cinturón de acero
Schneidbrett mit Edelstahlband

Noce - Walnut

	Ø Cm	Ø In
305 04 71 980	40	15,3/4



Tagliere pane in noce

Cutting board, walnut wood
Planche à découper
Brotschneidebrett Walnussholz
Tabla de cortar

	Cm	In
Tagliere e vassoio - Cutting board with tray		
305 54 54 618	52,5 x 35	20,6 x 13,7

Tagliere - Cutting board		
305 54 54 617	52,5 x 35	20,6 x 13,7

Vassoio - Tray		
305 54 23 854	52,5 x 35	20,6 x 13,7



Vassoio refrigerato

Thermal tray
Plateau réfrigéré
Bandeja refrigerada
Thermo-Platte

Noce - Walnut

	Cm	In
305 54 52 730	52,5 x 32,5	20,5/8 x 12,3/4





Set piastra con alzata

Hot buffet set with podium
Buffet chaud avec support
Set plancha con soporte
Hot Buffet Set mit Podest

Nero opaco - Matte black

	Cm	H Cm	In	H In
305 44 54 614	17,5 x 52,5	13,5	6,7/8 x 20,5/8	5,3/4

Cromato - Chromed

	Cm	H Cm	In	H In
305 05 54 614	17,5 x 52,5	13,5	6,7/8 x 20,5/8	5,3/4

Piatto torta con cloche Nature Buffet

Cake plate with Nature Buffet dome cover
Plat à gâteau avec cloche Nature Buffet
Plato tarta con cúpula Nature Buffet
Tortenplatte mit Glocke Nature Buffet

	Ø Cm	Ø In
305 54 42 699	40	15,3/4



Alzata quadrata per piatto torta quadrato

Square podium for square cake plate
Support carré pour plat à gâteau carré
Soporte cuadrado para plato pastel cuadrado
Podest quadratisch

	Cm	H Cm	In	H In
305 54 42 667	26 x 26	20	10,2 x 10,2	7,7/8

● nero - black

305 05 42 667	26 x 26	20	10,2 x 10,2	7,7/8
---------------	---------	----	-------------	-------

● cromato - cromato



Piatto torta con cloche non incluso / Cake plate not included



Cavalletto portaetichetta per buffet

Buffet easel for tags
Chevalet porte-nom pour buffet
Soporte caballete para etiqueta para buffet
Aufsteller Produktinfo

Acciaio inox 18/10 - St. Steel

	Cm	H Cm	In	H In
V01 05 19 001	7 x 7	15	2,3/4 x 2,3/4	6

Tavoletta nera per cavalletto

Black tag for easel
Plaque noire pour chevalet
Etiqueta negra para soporte caballete
Schild für Produktinfo

Plexiglass

	Cm	In
V01 12 19 001	10 x 7,5	4 x 3



Rinfrescacaraffe 4 comparti

Thermal pitcher, 4-pc set
Rafraîchisseur à 4 carafes
Enfriador para 4 jarras
Thermo-Karaffehalter 4 Stck.

Noce - Walnut

	Cm	H Cm	In	H In
305 54 24 586	28 x 28	9	11 x 11	3,1/2

**Rinfrescacaraffe 2 comparti**

Double thermal pitcher
Rafraîchisseur à 2 carafes
Enfriador para 2 jarras
Thermo-Karaffehalter 2 Stck.

Noce - Walnut

	Cm	In
305 54 52 634	21,5 x 38,5	8,1/2 x 15,1/8

**Caraffa vetro con coperchio basculante**

Glass pitcher Lt.1,5 with rolltop lid
Carafe à eau avec couvercle basculante
Jarra vidrio con tapa giratoria
Wasserkaraffe

ACQUA NATURALE/STILL WATER

	Cm	H Cm	Lt	Oz
305 05 08 548	29	11,4	1	35

ACQUA FRIZZANTE/SPARKLING WATER

	Cm	H Cm	Lt	Oz
305 05 08 549	29	11,4	1	35

**Rinfrescacaraffe 1 comparto**

Thermal pitcher, individual
Rafraîchisseur à carafes individuel
Enfriador de jarras individual
Thermo-Karaffehalter 1 Stck.

Noce - Walnut

	Cm	In
305 54 52 731	21,5 x 21,5	8,1/2 x 8,1/2

**Coppa macedonia**

Thermal fruit salad bowl
Rafraîchisseur salade de fruits
Bol macedonia de frutas refrigerado
Thermo-Fruchtsalatschale

Noce - Walnut

	Cm	In
305 54 52 641	28 x 28	11 x 11

**Caraffa succhi con coperchio**

Juice pitcher with lid
Carafe à jus avec couvercle
Jarra zumo con tapa
Saftkrug mit Deckel

	Lt	Oz
305 05 08 539	1,5	53

**Set 2 coppe yogurt**

Thermal yogurt set, 2-bowl
Set 2 bols yaourt réfrigérés
Set 2 boles yogur refrigerados
Thermo-Schalen 2 Stck.

Noce - Walnut

	Cm	In
305 54 52 640	21,5 x 38,5	8,1/2 x 15,1/8



Distributore succhi

Thermal juice dispenser
 Distributeur de jus réfrigéré
 Dispensador de zumo refrigerado
 Thermo-Saftspender

Noce - Walnut

	Lt	Oz	Cm	H Cm	In	H In
305 54 52 644	3,5	122,5	23 x 32	48	9 x 12,5/8	19
305 54 52 633	7	245	28 x 35,5	53	11 x 14	20,7/8

**Vassoio formaggi refrigerato**

Thermal cheese/cold cuts tray
 Plateau à fromage/charcuterie réfrigéré
 Bandeja quesos/embutidos refrigerada
 Thermo-Aufschnittplatte

Noce - Walnut

	Cm	H cm	In	H In
305 54 54 577	52 x 32,5	21,5	20,5/8 x 12,3/4	8,1/2

**Distributore caffè**

Coffee urn
 Distributeur de café
 Dispensador de café
 Kaffespender

Noce - Walnut

	Lt	Oz	Cm	H Cm	In	H In
305 54 52 631	7	245	28 x 35,5	54	11 x 14	21,1/4
305 54 52 632	10	350	28 x 35,5	62	11 x 14	24,3/8

**Vassoio refrigerato**

Thermal tray, ice packs on demand
 Plateau réfrigéré, blocs réfrigérants sur demande
 Bandeja refrigerada, acumuladores de frío disponibles
 Thermo-Platte, Kühlelemente auf Anfrage

Noce - Walnut

	Cm	H cm	In	H In
305 54 52 699	52.5 x 32.5	4	20,5/8 x 12,3/4	1,5/8

EUTETTICI INCLUSI

ICE PACKS INCLUDED

BLOCS RÉFRIGÉRANTS INCLUS

ACUMULADORE DE FRÍO INCLUIDOS

KÜHLAKKUS INKLUSIVE

**Distributore cereali**

Cereal dispenser
 Distributeur céréales
 Dispensador cereales
 Cerealienspender 1-fach

Noce - Walnut

	Lt	Oz	Cm	H Cm	In	H In
305 54 52 636	4	122,5	23 x 32	56	9 x 12,5	22

**Vassoio yogurt refrigerato con ghiaccio**

Zeta ice thermal yogurt tray
 Plateau à yaourts réfrigéré à glace Zeta
 Bandeja yogures refrigerable con hielo Zeta
 Joghurtablett Zeta, mit Eis kühlbar

Noce - Walnut

	Cm	H cm	In	H In
305 54 52 638	52.5 x 32.5	4	20,5/8 x 12,3/4	1,5/8



Jambee distributore marmellata/miele con base in legno

Jambee jam/honey dispenser with wood base
 Distributeur confiture/miel Jambee avec base en bois
 Jambee distribuidor de mermelada/miel con base de madera
 Jambee Konfitür/honigspender mit Holzbasis

Noce - Walnut

	Lt	Oz	Cm	In
305 05 52 721	0,7	23	12,5 x 34,5 H Min 40,5 H Ma x 54	5 x 13,5/8 H Min 16 H Ma x 21,1/4
305 05 52 722	1	33,8	12,5 x 34,5 H Min 48 H Ma x 70	5 x 13,5/8 H Min 18,7/8 H Ma x 27,1/2



Jambee

Jambee
 Jambee
 Jambee
 Jambee

Acciaio Inox 18/10 - St. Steel

	Lt	Oz	Cm	In
V77 0552 DMB	0,7	23	12,5 x 34,5 H Min 39 H Ma x 54	5 x 13,5/8 H Min 15,3/8 H Ma x 21,1/4
V77 0552 DMC	1	33,8	12,5 x 34,5 H Min 47 H Ma x 69	5 x 13,5/8 H Min 18,1/2 H Ma x 27,1/8



Erogatore a siringa

Syringe nozzle
 Embout seringue
 Ausgieberspritze
 Boquilla jeringa

Inox 18/10 - St. Steel

Z77 4652 DMA



Pistone con coperchio

Piston with lid
 Piston avec couvercle
 Kolben mit Deckel
 Pistón con tapa

Inox 18/10, Metacrilato e PP - St. Steel, Methacrylate and PP

	Lt
Z77 9852 DMA	0,7
Z77 9852 DMA1	1

Contentitore

Container
 Conteneur
 Behälter
 Contenedor

Metacrilato - Methacrylate

	Lt
Z77 2052 DMA	0,7
Z77 2052 DMA1	1

Tappo

Cap
 Capsule
 Stöpsel
 Tapón

Metacrilato - Methacrylate

Z77 1352 DMA

Targhetta porta etichetta

Label plate
 Plaque porte-étiquette
 Schild Etikettenhalter
 Placa porta etiqueta

Metacrilato - Methacrylate

Z77 5752 DMA1



Zeta Buffet



Distributore caffè

Coffee urn
 Distributeur de café
 Dispensador de café
 Kaffeespender

	Lt	Cm	H Cm
305 05 52 631 <input checked="" type="checkbox"/>	7	25 x 35	54
305 45 52 631 <input type="checkbox"/>			
305 05 52 632 <input checked="" type="checkbox"/>	10	25 x 35	62
305 45 52 632 <input type="checkbox"/>			



Distributore cereali

Cereal dispenser
 Distributeur céréales
 Dispensador cereales
 Cerealien-spender 1-fach

	Kg	Cm	H Cm
305 05 52 636 <input checked="" type="checkbox"/>	1,5	15 x 24	58
305 45 52 636 <input type="checkbox"/>			



Distributore succhi refrigerato

Thermal juice dispenser
 Distributeur de jus réfrigéré
 Dispensador de zumo refrigerado
 Thermo-Saftspender

	Lt	Cm	H Cm
305 05 52 633 <input checked="" type="checkbox"/>	7	25 x 35	53
305 45 52 633 <input type="checkbox"/>			
305 05 52 644 <input checked="" type="checkbox"/>	3,5	18 x 30	48
305 45 52 644 <input type="checkbox"/>			



Distributore cereali 2 comparti

Double cereal dispenser
 Distributeur céréales double
 Dispensador cereales doble
 Cerealien-spender 2-Fach

	Kg	Cm	H Cm
305 05 52 635 <input checked="" type="checkbox"/>	2 x 1,5	25 x 32	58
305 45 52 635 <input type="checkbox"/>			



**Rinfrescacaraffe 2 comparti**

Double thermal pitcher
 Rafrâchisseur à 2 carafes
 Enfriador para 2 jarras
 Thermo-Karaffenhalter 2 Stck.

	Cm	H Cm	Lt
305 05 52 634 ■	42 x 24	22	1,5
305 45 52 634 □			

**Caraffa succhi con coperchio**

Juice pitcher with lid
 Carafe à jus avec couvercle
 Jarra zumo con tapa
 Saftkrug mit Deckel

	Lt	Oz
305 05 08 539	1,5	53

**Rinfrescacaraffe 4 comparti acciaio inox**

Thermal pitcher 4-pc set
 Rafrâchisseur à 4 carafes
 Enfriador para 4 jarras
 Thermo-Karaffehalter 4 Stck.

	Cm	In	H Cm	H In
305 05 24 586 ■	30 x 30	11,8 x 11,8	8,5	3,3
305 45 24 586 □				

* caraffe incluse / included pitcher

**Caraffa vetro con coperchio basculante**

Glass pitcher Lt.1,5 with rolltop lid
 Carafe à eau avec couvercle basculante
 Jarra vidrio con tapa giratoria
 Wasserkaraffe

ACQUA NATURALE/STILL WATER

	Cm	H Cm	Lt	Oz
305 05 08 548	29	11,4	1	35

ACQUA FRIZZANTE/SPARKLING WATER

	Cm	H Cm	Lt	Oz
305 05 08 549	29	11,4	1	35



Rinfrescabottiglie termico 3 posti

3-bottle cooler
Rafraichisseur à 3 bouteilles
Enfriador para 3 botellas
Flaschenkühler 3-Fach

	Cm	H Cm
305 05 52 646 ■	42 x 24	23,5
305 45 52 646 □		

**Set 2 coppe yogurt refrigerate**

Thermal yogurt set, 2-bowl
Set 2 bols yaourt réfrigérés
Set 2 boles yogur refrigerados
Thermo-Schalen 2 Stck.

305 05 52 640 ■
 305 45 52 640 □



Cm 42 x 24 x H. 13,5 Ø 15 Cm Lt 0,5

Set 2 coppe macedonia refrigerate

Thermal fruit-salad set, 2-bowl
Set 2 bols salade de fruits réfrigérés
Set 2 boles macedonia de frutas refrigerados
Thermo-Fruchtsalatschale 2 Stck. schwarz

305 05 52 637 ■
 305 45 52 637 □



Cm 55 x 34,5 x H 16 Ø 23 Cm Lt 1,8

Coppa macedonia refrigerata

Thermal fruit salad bowl
Rafraichisseur salade de fruits
Bol macedonia de frutas refrigerado
Thermo-Fruchtsalatschale

305 05 52 641 ■
 305 45 52 641 □



Cm 30 x 30 x H 16 Ø 23 Cm Lt 1,8

Supporto alto per 3 coppette

3-bowl podium, tall
Support haut à 3 coupelles
Soporte alto para 3 boles
Buffetständer 3 Bowlst

	Cm	H Cm	Ø Cm	Lt.
305 05 54 580 ■	42,5 x 15	19	12	0,25
305 45 54 580 □				

**Supporto basso per 3 coppette**

Podium 3-bowl, short
Support bas à 3 coupelles
Soporte bajo para 3 boles
Buffetständer 3 Bowlst

	Cm	H Cm	Ø Cm	Lt.
305 05 54 579 ■	42,5 x 15	11,5	12	0,25
305 45 54 579 □				

Coperchio in metacrilato con pom. per coppa

Bowl cover
Couvercle metachrilè pour coupe en verre
Tapa acrílica con pom. para boles
Acryldeckel m. Griff f. Glassch.

	Ø Cm
305 12 15 798	12

**Supporto alto per 2 coppe cereali con coperchio**

2-bowl podium with lids, tall
Support haut à 2 coupes avec couvercles
Soporte alto para 2 boles con tapas
Buffetständer 2 Bowlst mit Deckel

	Cm	H. Cm	Ø Cm	Lt
305 05 54 607 ■	62 x 28	30	23	1,8
305 45 54 607 □				

**Supporto basso per 2 coppe cereali con coperchio**

2 bowl podium with lids, short
Support bas à 2 coupes avec couvercles
Soporte bajo para 2 boles con tapas
Buffetständer 2 Bowlst mit Deckel

	Cm	H Cm	Lt
305 05 54 606 ■	55 x 28	10	1,8
305 45 54 606 □			



Vassoio formaggi ed affettati refrigerato

Thermal cheese/cold cuts tray
 Plateau à fromage/charcuterie réfrigéré
 Bandeja quesos/embutidos refrigerada
 Thermo-Aufschnittplatte

	Cm	H Cm
305 05 54 577 ■	55 x 34,5	20
305 45 54 577 □		

**Cestino pane acciaio inox**

Bread basket with roll-top cover
 Corbeille à pain avec couvercle roll-top
 Cesta pan con tapa roll-top
 Brotkorb mit Rolltop

	Cm	H Cm
305 05 52 650 ■	55 x 34,5	25
305 45 52 650 □		

**Vassoio refrigerato, eutettici a richiesta**

Thermal tray, ice packs on demand
 Plateau réfrigéré, blocs réfrigérants sur demande
 Bandeja refrigerada, acumuladores de frío disponibles
 Thermo-Platte, Kühlelemente auf Anfrage

	Cm	H Cm
305 05 52 699 ■	55 x 34,5	4
305 45 52 699 □		

**Cestino portapane con cloche**

Bread basket with roll-top cover
 Corbeille à pain avec couvercle roll-top
 Cesta pan con tapa roll-top
 Rattan Brotkorb mit Rolltop

	Cm	H Cm
305 05 52 642 ■	55 x 34,5	30
305 45 52 642 □		

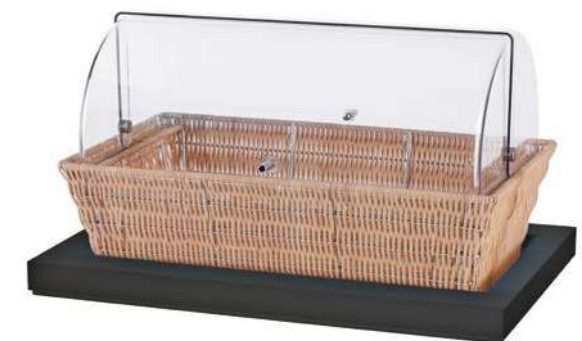
**Vassoio yogurt Zeta refrigerato con ghiaccio**

Zeta ice thermal yogurt tray
 Plateau à yaourts réfrigéré à glace Zeta
 Bandeja yogures refrigerable con hielo Zeta
 Joghurtablett Zeta, mit Eis kühlbar

	Cm	H Cm
305 05 52 638 ■	55 x 34,5	4
305 45 52 638 □		

**Tagliere pane con base**

Bread cutting board with base
 Planche à pain avec plateau
 Tabla de cortar con base
 Brotschneidebrett

	Cm	H Cm
305 05 54 578 ■	55 x 34,5	6
305 45 54 578 □		



Scaldabrioche

Croissant warmer
 Chauffe-croissants
 Calienta croissants
 Croissantwärmer



Cm H Cm
 55 x 34,5 24,3

305 05 52 651 ■
 305 45 52 651 □

**Alzata filo per basi GN 1/1**

Wire stand for GN 1/1
 Support en fil pour GN 1/1
 Soporte en hilo para GN 1/1
 Buffetständer mit GN 1/1 Einsatz

Cm H Cm
 305 05 42 597 57,5 x 35,8 27,6

**Supporto con schermo igienico GN 1/1**

Stand with hygienic shield
 Ecran hygiénique
 Pantalla higiénica
 Buffetständer mit Hygieneplatte

Cm
 305 12 53 609 59 x 34,4

**Alzata torta con cloche**

Cake stand with roll-top cover
 Présentoir à gâteau x avec couvercle roll-/top
 Presentación tarta con tapa roll-top
 Tortenplatte mit Rolltop

Ø Cm Base Cm H Cm
 305 05 42 600 ■ 38 18 x 18 37,2
 305 45 42 600 □

**Coppa punch**

Punch bowl
 Bol à punch
 Champañera
 Punch Bowl

Ø Cm Base Cm H Cm
 305 05 43 613 ■ 40 18 x 18 33
 305 45 43 613 □

**Vassoio multifunzione rettangolare**

Rectangular multipurpose tray
 Plateau multi-usage rectangulaire
 Bandeja multiuso rectangular
 Multifunktionstablett rechteckig

Cm H Cm
 305 05 52 652 ■ 55 x 34,5 4
 305 45 52 652 □

**Vassoio multifunzione quadrato**

Square multipurpose tray
 Plateau multi-usage carré
 Bandeja multiuso cuadrada
 Multifunktionstablett viereckig

Cm H Cm
 305 05 52 654 ■ 30 x 30 4
 305 45 52 654 □



Manhattan Buffet



SET 1

Manhattan Tower
Tower Manhattan
Tower Manhattan
Manhattan Tower

	Cm	H Cm
305 05 52 A01	140 x 42	65



Tower

Tower
Tower
Tower
Tower

	Cm	H Cm
305 05 42 604	20 x 20	10
305 05 42 605	20 x 20	22
305 05 42 606	20 x 20	34
305 05 42 607	20 x 20	58



SET 2

Manhattan Tower
Tower Manhattan
Tower Manhattan
Manhattan Tower

	Cm	H Cm
305 05 52 A02	140 x 42	50



SET 3

Manhattan Tower
Tower Manhattan
Tower Manhattan
Manhattan Tower

	Cm	H Cm
305 05 52 A03	150 x 145	65



Modulo a croce

Cross-shaped e x tension unit
Croi x
Módulo con forma de cruz
Verbindungskreuz

	H Cm
305 05 42 608	9,5

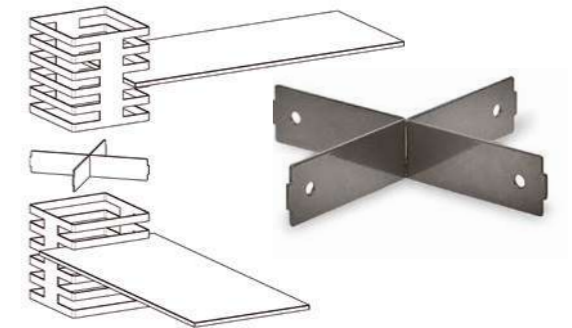

SET 4

Manhattan Tower
Tower Manhattan
Tower Manhattan
Manhattan Tower

	Cm
305 05 52 A04	260 x 42



Coppa quadrata in vetro

Bowl, square, glass
Bol carré en verre
Bol cuadrado de cristal
Quadratische Glasschale

	Cm	H cm
V87 04 42 Q01	34 x 34	11



Manhattan

Piano in vetro fumé

Smoky glass top
 Dessus en verre fumé
 Tablero de cristal fumé
 Glasplatte Smoky

	Cm
V87 08 42 Q01	30 x 30
V87 08 42 Q02	42 x 42
V87 08 42 R01	30 x 70
V87 08 42 R02	30 x 100
V87 08 42 R03	42 x 70
V87 08 42 R04	42 x 100



Piano in ardesia

Slate top
 Dessus en ardoise
 Tablero de pizarra
 Schieferplatte

	Cm
V87 09 42 Q01	30 x 30
V87 09 42 Q02	42 x 42
V87 09 42 R01	30 x 70
V87 09 42 R02	30 x 100
V87 09 42 R03	42 x 70
V87 09 42 R04	42 x 100



Piano in mdf

Mdf top
 Dessus en mdf
 Tablero de mdf
 Mdf Platte

	Cm
V87 04 42 Q01	30 x 30
V87 04 42 Q02	42 x 42
V87 04 42 R01	30 x 70
V87 04 42 R02	30 x 100
V87 04 42 R03	42 x 70
V87 04 42 R04	42 x 100



Totem

Totem
 Totem
 Totem
 Totem

	Cm	H Cm
305 05 42 609	24 x 24	14
305 05 42 610	24 x 24	22
305 05 42 611	32,5 x 32,5	14
305 05 42 612	32,5 x 32,5	22



Caratteristiche tecniche

- A** Asportabilità del coperchio a 90° con estrema facilità.
- B** Coperchio leggero e facilmente maneggiabile.
- C** Blocco automatico dell'estrazione del coperchio in fase di lavoro (da 0° a 89°).
- D** Chiusura e apertura frenata del coperchio. Sistema di cerniere brevettate Abert
- E** Superati i 70° il coperchio si apre completamente lasciandolo andare.
- F** La cerniera è un meccanismo a molla, inalterabile nel tempo, non necessita di regolazione e di manutenzione in quanto non ha frizione.
- G** Tutti i meccanismi sono costruiti in pregiati materiali Inossidabili, quindi resistenti alla corrosione, agli ambienti umidi e adatti al contatto con gli alimenti.
- H** Lo scaldavivande è progettato per raccogliere la condensa in modo da lasciare il piano di appoggio completamente asciutto.
- I** Può essere utilizzato sia con riscaldamento elettrico sia con fornelli a combustibile solido.

Technical characteristics

- A** Easily removable cover, at 90°.
- B** Light and easy-to-handle cover.
- C** Automatic block of cover pull out when in operation (from 0° to 89°).
- D** Closing and opening slowed by cover. Abert patented system.
- E** Over 70° the cover opens fully when released.
- F** The hinge is a spring mechanism, inalterable in time, it does not need regulation and maintenance as it has no clutch.
- G** All the machineries are built in refined stainless materials, thus resistant to corrosion, humid environment and suitable for food contact.
- H** The chafing dish is designed to collect condensation, In order to keep the support base completely dry.
- I** Both electric warming and solid-fuelburners can be used.

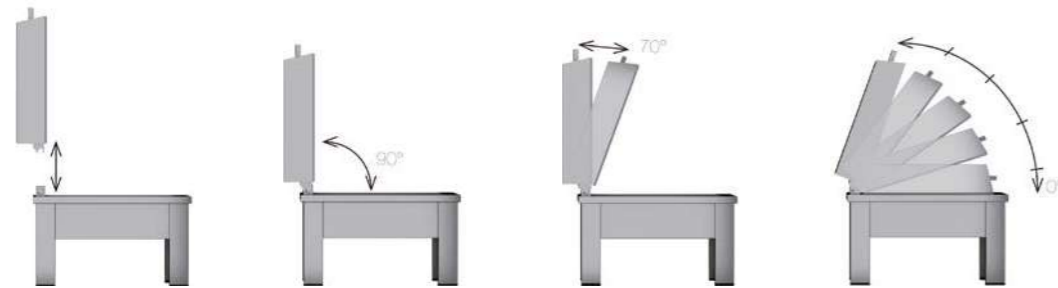

Piastra elettrica Gn 2/3

Electric plate for Ø Cm 30-40 round chafing dish
Élément électrique pour chafing-dish rond Ø Cm 30-40
Elemento eléctrica para chafing dish redondo Ø Cm 30-40
Elektroelement für runden Chafing Dish Ø Cm 30-40
 305 05 52 546
 305 05 52 611 con regolatore - with regulator

Piastra elettrica Gn 1/1

Electric hot plate
Plaque électrique
Placa eléctrica
Elektrische Platte
 305 05 52 547
 V77 05 52 PCR2 con regolatore - with regulator

Fornelletto per scaldavivande

Chafing-dish burner
Porte brûleur pour chafing dish
Contenedor de combustible para chafing dish
Brennstoffhalter für Chafing Dish
 305 05 52 536

Combustibile per scaldavivande

Solid fuel for chafing dish burner
Combustible pour chafing dish
Combustible para chafing dish
Brennstoff für Chafing Dish
 305 05 72 519



Scaldavivande con gambe e coperchio in acciaio inox

Chafing dish with St. Steel stand and cover
Chafing dish avec support et couvercle en acier inox
Chafing dish con soporte y tapa en acero inox
Chafing Dish mit Beinen und Edelstahldeckel

	Cm	H Cm
GN 1/1		
305 05 52 670	63 x 42	31
GN 2/3		
305 05 52 675	46 x 42	32

Completo di due fornelli a combustibile solido e predisposto per piastra elettrica.
 Portavivande GN 1/1 in acciaio incluso

With 1/1 Gastronorm food pan and two solid fuel burners.
Electric heating element available.



Scaldavivande con gambe e coperchio acciaio inox / vetro

Chafing dish with St. Steel/glass stand and cover
Chafing dish avec support et couvercle en acier inox / verre
Chafing dish con soporte y tapa en acero inox / vidrio
Chafing Dish mit Beinen und Edelstahl / Glass deckel

	Cm	H Cm
GN 1/1		
305 05 52 679	63 x 43	33
GN 2/3		
305 05 52 683	46 x 42	32

Completo di due fornelli a combustibile solido e predisposto per piastra elettrica.
 Portavivande GN 1/1 in acciaio incluso

With 1/1 Gastronorm food pan and two solid fuel burners.
Electric heating element available.



Scaldavivande da incasso con coperchio in acciaio inox / vetro

Built-in chafing dish with St. Steel / glass cover
 Chafing dish encastrable avec couvercle en acier inox / verre
 Chafing dish para empotrar con tapa en acero inox / vidrio
 Chafing Dish zum Einbauen mit Edelstahl / Glass Deckel

	Cm	H Cm
GN 1/1		
305 05 52 692	60,5 x 40	39,5
GN 2/3		
305 05 52 694	43 x 40	21

Refrigerato / Thermal

GN 1/1		
305 05 52 705	60,5 x 40	39,5

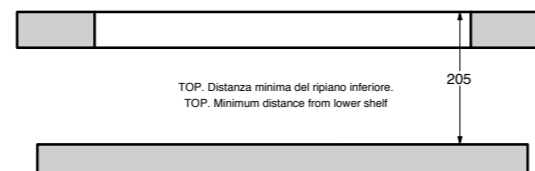
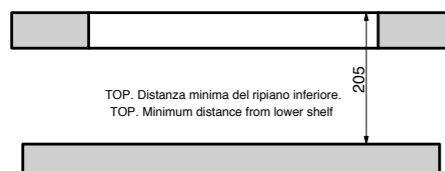
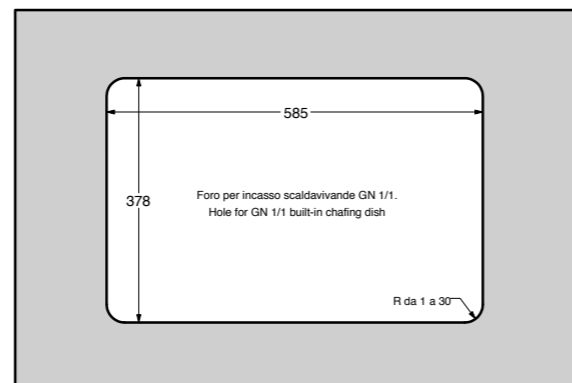
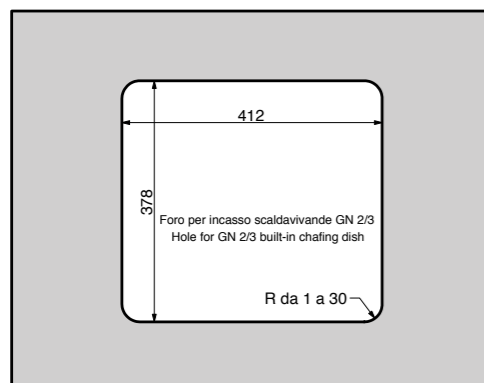

Scaldavivande da incasso con coperchio in acciaio inox

Built-in chafing dish with St. Steel cover
 Chafing dish encastrable avec couvercle en acier inox
 Chafing dish para empotrar con tapa en acero inox
 Chafing Dish zum Einbauen mit Edelstahl Deckel

	Cm	H Cm
GN 1/1		
305 05 52 693	60,5 x 40,5	39,5
GN 2/3		
305 05 52 695	43 x 40	21

Refrigerato / Thermal

GN 1/1		
305 05 52 706	60,5 x 40,5	39,5



Scaldavivande a incastro GN 1/1

GN 1/1 built-in chafing dish
 Chafing dish encastrable GN 1/1
 Chafing dish empotrable GN 1/1
 Eingebautes Chafing Dish GN 1/1

305 05 52 665
 Con coperchio in acciaio inox
 With Stainless steel cover

305 05 52 678
 Con coperchio in vetro
 With glass cover

Completo di due fornelli a combustibile solido e predisposto per piastra elettrica. Portavivande GN 1/1 in acciaio incluso. Supporti Manhattan esclusi

With 1/1 Gastronorm food pan and two solid fuel burners. Electric heating element available. Manhattan stand excluded

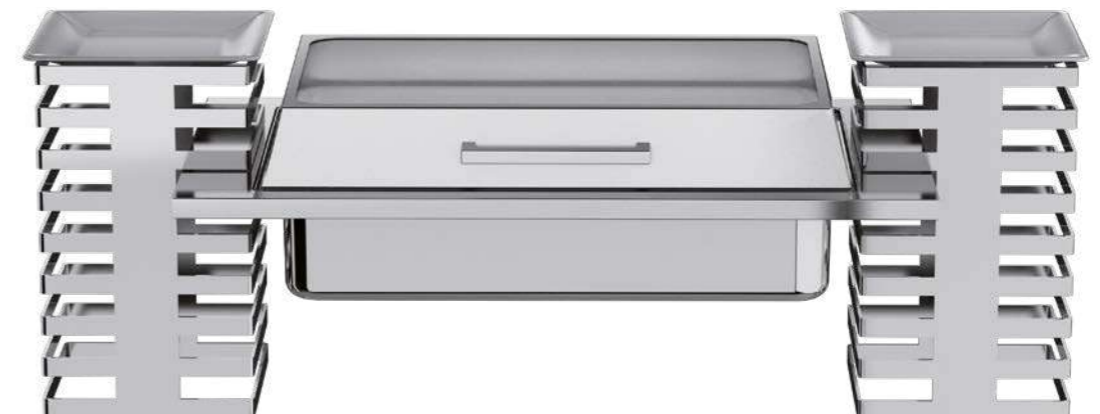

Set refrigerato a incastro GN 1/1

GN 1/1 built-in thermal set
 Set réfrigéré encastrable GN 1/1
 Set refrigerado empotrable GN 1/1
 Eingebautes Thermo-Einsatz GN 1/1

305 05 52 698
 Con coperchio in vetro
 With glass cover

Set refrigerato GN 1/1 H.7,2 Cm completo di bacinella in acciaio inox , griglia in acciaio inox , eutettici, vassoio GN 1/1 H.Cm 2 in acciaio inox . Supporti Manhattan esclusi

Thermal set GN 1/1 H. 7,2 Cm with St. Steel pan, St. Steel grid, ice packs, St. Steel tray GN 1/1 H. Cm 2. Manhattan stand excluded

Set refrigerato Manhattan affettati e formaggi

Manhattan thermal set, cold cuts/cheese
 Set réfrigéré Manhattan charcuterie(fromages)
 Set refrigerado Manhattan embutidos y quesos
 Gekühltes Set Manhattan für Aufschnitt und Käse

	Cm	h
305 05 52 767	62 x 42	22

GN 1/1 PORCELLANA H 2 Cm
 + inglese (GN 1/1 PORCELLANA H 2 Cm)



Set refrigerato Manhattan per frutta

Manhattan thermal set for fruit
 Set réfrigéré Manhattan pour fruits
 Set refrigerado Manhattan para frutas
 Gekühltes Set Manhattan für Obst

	Cm	h
305 05 52 766	62 x 42	22

3 x GN 1/3 PORCELLANA H 6,5 Cm
 +inglese (3 x GN 1/3 PORCELLANA H 6,5 Cm)



Set refrigerato Manhattan da appoggio

Manhattan thermal set (cold), self-standing
 Set réfrigéré Manhattan à poser
 Set refrigerado Manhattan sobre encimera
 Manhattan Thermoset (kalt), selbststehend

	Cm	h
305 05 52 764	62 x 42	22

GN 1/1 ACCIAIO H 6,5 Cm
 +inglese (GN 1/1 ACCIAIO H 6,5 Cm)



Set riscaldato Manhattan da appoggio

Manhattan thermal set (hot), self-standing
 Set chauffant Manhattan à poser
 Set calentador Manhattan sobre encimera
 Manhattan Thermoset (heiß), selbststehend

	Cm	h
305 05 52 765	62 x 42	22

GN 1/1 ACCIAIO H 6,5 Cm
 +inglese (GN 1/1 ACCIAIO H 6,5 Cm)



Inserto GN 1/1 in acciaio inox
 Food pan, GN 1/1 18/10, stainless steel
 V01 05 72 G11B

H. 6,5 Cm



Vassoio GN 1/1 in acciaio inox
 Tray, Gn 1/1, stainless steel
 V01 05 72 G11

H. 2 Cm



Inserto GN 2/3 in acciaio inox
 Food pan, GN 2/3 18/10, stainless steel
 V01 05 72 G23B

H. 6,5 Cm



Inserto GN 1/3 in acciaio inox
 Food pan, GN 1/3 18/10, stainless steel
 V01 05 72 G13B

H. 6,5 Cm



Inserto GN 1/2 in acciaio inox
 Food pan, GN 1/2 18/10, stainless steel
 V01 05 72 G12B

H. 6,5 Cm



Inserto GN 1/1 in porcellana
 Food pan, GN 1/1, porcelain
 305 21 52 557

H. 6,5 Cm



Inserto GN 1/1 in porcellana
 Food pan, GN 1/1, porcelain
 3052152672

H. 2 Cm



Inserto GN 2/3 in porcellana
 Food pan, GN 2/3, porcelain
 305 21 52 583

H. 6,5 Cm



Inserto GN 1/2 in porcellana
 Food pan, GN 1/2, porcelain
 305 21 52 581

H. 6,5 Cm



Inserto GN 1/3 in porcellana
 Food pan, GN 1/3, porcelain
 305 21 52 582

H. 6,5 Cm



Piatto piano quadrato in porcellana
 Square flat plate, porcelain
 263 33 42 649

22 x 22 Cm



Piatto fondo quadrato in porcellana
 Square deep plate, porcelain
 263 33 42 130

22 x 22 Cm





Classica Buffet

COD. 303 07..... acciaio argentato - electro-plated stainless steel (EPSS)
 COD. 303 03..... acciaio argentato e ottone - electro-plated stainless steel (EPSS) and brass
 COD. 303 05..... acciaio e ottone - stainless steel and brass
 COD. 303 55..... acciaio inossidabile - stainless steel

Distributore caffè linea classica

Classica coffee urn
 Distributeur de café Classica
 Dispensador de café Classica
 Kaffeedispenser Classica

	Lt	Oz	Cm	H Cm
303 ... 52 549	7	245	32 x 25	53
303 ... 52 550	10	350	24 x 32	52



Distributore succhi linea classica

Classica juice dispenser
 Distributeur de jus Classica
 Dispensador de zumo Classica
 Saftspender Classica

	Lt	Oz	Cm	H Cm
303 ... 52 603	8	280	25 x 36	72



Scaldavivande tondo linea Classica

Classica round chafing dish
 Chafing dish rond Classica
 Chafing dish redondo Classica
 Chafing Dish Classica, rund

	Ø Cm	Ø In
303 .. 52 614	40	15,3/4

Con cloche rotante (180°) a scomparsa, fornito di portavivande Gastronorm e due bruciatori a combustibile solido. Predisposto per piastra elettrica.

With revolving foldaway dome opening at 180°, Gastronorm food pan and two solid fuel burners. Electric heating element available.



Scaldavivande rettangolare linea Classica

Classica rectangular chafing dish
 Chafing dish rectangulaire Classica
 Chafing dish rectangular Classica
 Chafing Disch Classica , rechteckig

	GN	In	Cm	H Cm
303 .. 52 612	1/1	1/1	67 x 43	45

Con cloche rotante (180°) a scomparsa, fornito di portavivande 1/1 Gastronorm e due bruciatori a combustibile solido. Predisposto per piastra elettrica.

With revolving foldaway dome opening at 180°, 1/1 Gastronorm food pan and two solid fuel burners. Electric heating element available.



Piastra elettrica per distributore caffè

Electric heating element for coffee urn



Piastra elettrica rettangolare per scaldavivande gn 1/1

Electric heating element for GN1/1 rectangular chafing dish



Piastra elettrica per scaldavivande tondo Ø Cm 30-40

Electric heating element for Ø Cm 30-40 chafing dish



Fornelletto per scaldavivande

Chafing dish burner



COD. 305 07..... acciaio argentato - electro-plated stainless steel (EPSS)
 COD. 305 03..... acciaio argentato e ottone - electro-plated stainless steel (EPSS) and brass
 COD. 305 05..... acciaio e ottone - stainless steel and brass
 COD. 305 55..... acciaio inossidabile - stainless steel

Alzata rettangolare linea Classica

Classica rectangular stand
 Présentoir rectangulaire Classica
 Soporte rectangular Classica
 Rechteckiger Ständer, Classica

	Cm	In	H. Cm.	H In	
303 .. 52 702	28 x 49	11 x 19,1/4	21		8,1/4

Vassoio refrigerato - Thermal tray
 305 .. 54 611 GN 1/1



Distributore Aqva con alzata Classica

Aqva dispenser with Classica stand
 Distributeur Aqva avec support Classica
 Dispensador Aqva con soporte Classica
 Aqua Getränkespender mit Ständer Classica

	Ø Cm	H Cm	Ø In	H in
305 .. 52 712	27	63	10,5/8	24,8



Alzata tonda linea Classica

Classica round stand
 Présentoir rond Classica
 Soporte redondo Classica
 Runder Ständer, Classica

	Ø Cm	Ø In	H Cm.	H In
303 .. 52 703	22	8,5/8	21	8,1/4

Ciotola in porcellana - porcelain bowl
 264 02 53 170 28 11



Coppa punch con manici Rubans

Punch bowl with Rubans handles
 Bol à punch avec poignées Rubans
 Champañera con asas Rubans
 Punschschale mit Griff Rubans

	Ø Cm	Lt	Ø In	Oz
310 00 43 602	50	20	19,3/4	700



COD. 303 07..... acciaio argentato - electro-plated stainless steel (EPSS)
 COD. 303 03..... acciaio argentato e ottone - electro-plated stainless steel (EPSS) and brass
 COD. 303 05..... acciaio e ottone - stainless steel and brass
 COD. 303 55..... acciaio inossidabile - stainless steel



Alzata frutta

Fruit stand
 Plat à fruits sur pied
 Frutero
 Obständer

	Ø Cm	Ø In
310 00 42 574	30	11,3/4
310 00 42 539	40	15,3/4
310 00 42 549	54	21,1/4



Alzata frutta

Fruit stand
 Plat à fruits sur pied
 Frutero
 Obständer

	Ø Cm	Ø In
310 00 42 535	30	11,3/4



Alzata frutta 2-3-4 piani

Fruit stand, 2-3-4-tier
 Plat à fruits sur pied, 2-3-4 étages
 Frutero, 2-3-4 pisos
 Obständer, 2-3-4 stufig

		Ø Cm	H Cm	Ø In	H In
310 00 42 564	(2 piani / 2 tier)	30/25	49	11,3/4-9,7/8	19,5/16
310 00 42 565	(3 piani / 3 tier)	40/30/25	69	15,3/4-11,3/4-9,7/8	27
310 00 42 577	(3 piani / 3 tier)	54/40/30	69	21,1/4-15,3/4-11,3/4	27
310 00 42 571	(4 piani / 4 tier)	54/40/30/25	90	21,1/4-15,3/4-11,3/4-9,7/8	35,3/8

Alzata torta

Cake stand
 Presentoir à gâteau x
 Soporte pastel
 Tortenplatte

	Ø Cm	Ø In
310 00 42 526	32	12,5/8



Portaburro tondo

Butter cooler, round
Beurrier rond
Mantequera redonda
Butterkühler, rund

	Ø Cm	H Cm	Ø In	H In
V77 05 09 T32	32	6	12,5/8	2,3/8



Portaformaggi / affettati rettangolare refrigerato - piano in polietilene

Rectangular cheese / cold cuts dish, thermal - Polyethylene board
Plateau fromage / charcuterie rectangulaire réfrigérant - Planche en polyéthylène
Quesera rectangular refrigerante - Tabla de polietileno
Käse/Wurstwarenplatte - rechteckig, gekühlt, Platte aus Acryl

	Cm	In
V77 05 54 G11 R	53 x 32,5	20,7/8 x 12,3/4



Portaformaggi / affettati tondo refrigerato - piano in polietilene

Round cheese / cold cuts dish, thermal - Polyethylene board
Plateau fromage / charcuterie rond réfrigérant - Planche en polyéthylène
Quesera redonda refrigerante - Tabla de polietileno
Käse/Wurstwarenplatte - rund, gekühlt, Platte aus Acryl

	Ø Cm	Ø In
V77 05 54 T46 R	46	18,1/8



COD. 303 07..... acciaio argentato - electro-plated stainless steel (EPSS)
COD. 303 03..... acciaio argentato e ottone - electro-plated stainless steel (EPSS) and brass
COD. 303 05..... acciaio e ottone - stainless steel and brass
COD. 303 55..... acciaio inossidabile - stainless steel

Caraffa vetro acqua frizzante con coperchio basculante

Sparkling water glass pitcher with smart lid
Carafe en verre à eau gazeuse avec couvercle basculant
Jarra de vidrio agua con gas con tapa basculante
Wasser Karaffe (Kohlen säüve) mit Kippen Kappe

	Lt	Oz
305 05 08 549	1	35



Caraffa vetro con coperchio basculante

Water glass pitcher with smart lid
Carafe en verre avec couvercle basculant
Jarra de vidrio con tapa basculante
Wasser Karaffe mit Kippen Kappe

	Lt	Oz
305 05 08 548	1	35

Caraffa succhi con coperchio

Juice pitcher with lid
Carafe à jus avec couvercle
Jarra zumo con tapa
Saftkrug mit Deckel

	Lt	Oz
305 05 08 539	1,5	53



Caraffa succhi

Juice pitcher
Carafe à jus
Jarra zumo
Saftkrug
(Argentata - silver plated)

	Lt	Oz
310 07 08 546	2,0	70



COD. 303 07..... acciaio argentato - electro-plated stainless steel (EPSS)
 COD. 303 03..... acciaio argentato e ottone - electro-plated stainless steel (EPSS) and brass
 COD. 303 05..... acciaio e ottone - stainless steel and brass
 COD. 303 55..... acciaio inossidabile - stainless steel

Caraffa termica

Insulated beverage server
Pot isotherme
Jarra térmica
Termische Karaffe

	Lt	Oz
305 05 08 540	0,60	21
305 05 08 541	1,00	35
305 05 08 542	1,50	53



Caraffa termica cilindrica

Thermal beverage server, cylindrical
Pot isotherme cylindrique
Jarra térmica cilíndrica
Termische Karaffe, zylindrische
 Acciaio inossidabile - St. Steel

	Lt	Oz
305 05 08 540	0,60	21
305 05 08 541	1,00	35
305 05 08 542	1,50	53

305 42 08 ... coperchio black - black lid
 305 40 08 ... coperchio copper - copper lid
 305 41 08 ... coperchio gold - gold lid



Caraffa termica conica

Insulated beverage server, conical
Pot isotherme conique
Jarra térmica cónica
Termische Karaffe, konisch

	Lt	Oz
305 05 08 557	0,30	10
305 05 08 558	0,60	21
305 05 08 559	1,00	35
305 05 08 560	1,50	53



Caraffa termica conica

Thermal beverage server, conical
Pot isotherme conique
Jarra térmica cónica
Termische Karaffe, konisch
 Acciaio inossidabile - St. Steel

	Lt	Oz
305 05 08 557	0,30	10
305 05 08 558	0,60	21
305 05 08 559	1,00	35
305 05 08 560	1,50	53

305 42 08 ... coperchio black - black lid
 305 40 08 ... coperchio copper - copper lid
 305 41 08 ... coperchio gold - gold lid



Inserto GN 1/1 in acciaio inox

Food pan, GN 1/1 18/10, stainless steel

V01 05 72 G11B H. 6,5 Cm



Vassoio GN 1/1 in acciaio inox

Tray, Gn 1/1, stainless steel

V01 05 72 G11B H. 2 Cm



Inserto GN 2/3 in acciaio inox

Food pan, GN 2/3 18/10, stainless steel

V01 05 72 G23B H. 6,5 Cm



Inserto GN 1/3 in acciaio inox

Food pan, GN 1/3 18/10, stainless steel

V01 05 72 G13B H. 6,5 Cm



Inserto GN 1/2 in acciaio inox

Food pan, GN 1/2 18/10, stainless steel

V01 05 72 G12B H. 6,5 Cm



Inserto GN 1/1 in porcellana

Food pan, GN 1/1, porcelain

305 21 52 557 H. 6,5 Cm



Inserto GN 1/1 in porcellana

Food pan, GN 1/1, porcelain

3052152672 H. 2 Cm



Inserto GN 2/3 in porcellana

Food pan, GN 2/3, porcelain

305 21 52 583 H. 6,5 Cm



Inserto GN 1/2 in porcellana

Food pan, GN 1/2, porcelain

305 21 52 581 H. 6,5 Cm



Inserto GN 1/3 in porcellana

Food pan, GN 1/3, porcelain

305 21 52 582 H. 6,5 Cm



Set minestre per scaldavivande rettangolare

Soup tureen set for rectangular chafing dish
Set de soupières pour chafing dish rectangulaire
Set de soperas para chafing dish rectangular
Suppenchüsselset für Chafing Dish rechteckig

		Cm	In
305 05 52 626	Adattatore - Adapter	1/1	1/1

		Lt	Oz
305 05 15 796	Zuppiera - Soup tureen	4,2	142



Portavivande tondo in acciaio inossidabile

Round food pan, stainless steel
Bac rond en acier inox idable
Cubeta redonda en acero inox idable
Behälter rund, edelstahl rostfrei

	Ø Cm	Ø In
305 05 72 517	40	15,3/4



Portavivande tondo in porcellana

Round food pan, porcelain
Bac rond en porcelaine
Cubeta redonda en porcelana
Porzellanbehälter, rund

	Ø Cm	Ø In
305 21 52 559	40	15,3/4



Inserto scaldavivande tondo in porcellana

Food pan half round chafing dish, porcelain with divider
Bac double en porcelaine pour chafing dish rond
Cubeta en porcelana para chafing dish redondo
Porzellaninsatz, 2tlg für chafing dish rund

	Ø Cm	Ø In
305 21 71 951 (1 Pz.)	40	15,3/4



Portauovo per scaldavivande tondo in porcellana

Egg holder for round chafing dish, porcelain
Porte-oeufs en porcelaine pour chafing dish rond
Porta huevos en porcelana para chafing dish redondo
Porzellanereinsatz für chafing dish rund

	Cm	Ø In
305 21 71 950	40	15,3/4



Set zuppiera per scaldavivande tondo Cm 40

Soup tureen set for Cm 40 round chafing dish
Set de soupières pour chafing dish rond Cm 40
Set de soperas para chafing dish redondo Cm 40
Suppenchüsselset für Chafing Dish rund Ø Cm 40

		Ø Cm	Ø In
305 05 52 627	Adattatore - Adapter	40	15,3/4

		Lt	Oz
305 05 15 796	Zuppiera - Souptureen	4,2	142





Aqva



Distributore bevande riscaldato

Heated beverage dispenser
 Distributeur de boissons chauffé
 Dispensador de bebidas calentado
 Getränkespender, aufgewärmt

	Lt	Oz	H Cm.	H In
305 05 52 708	5	169	80	31,1/2



Samovar riscaldato

Heated Samovar
 Samovar chauffé
 Samovar calentado
 Samovar aufgewärmt

	Lt	Oz
305 05 52 707	5 + 1	169 + 35

Teiera in vetro / Glass teapot
 305 08 02 580 1 35



1 Regolatore di temperatura (dai 45°C ai 95°C)
 Temperature regulator (from 45°C to 95°C)

2 Tasto ON - OFF
 ON-OFF button

3 Spie luminose/Spie luminose:
 ● temperatura resistenza >80°C
 temperature of the resistance is > di 80°
 ● il livello del liquido è sotto al minimo
 level of liquid is below minimum
 ● lampeggiante - il liquido è in fase di riscaldamento
 flashing: the liquid heating up
 ● fisso - il liquido ha raggiunto la temperatura desiderata
 fi x ed: it has reached the temperature set on the control knob

Distributore Aqva con base in marmo di Carrara

Aqva dispenser with Carrara marble stand
 Distributeur Aqva avec support en Carrara marbre
 Dispensador Aqva con soporte en Carrara mármol
 Getränkespender Aqva mit Ständer aus Carrara Marmor

Marmo di Carrara e vetro - Carrara Marble and glass

	H Cm	H In
305 54 52 729	63	24.8

Il nostro **AQVA** è innovativo, per il suo design elegante ed originale e perché permette, grazie alla doppia parete, di avere una lentissima dispersione della temperatura del liquido interno.

Our **AQVA** is innovative for having an elegant and original design and because it allows, thanks to the double wall, to have an extremely low temperature dispersion of the inside liquid.



Distributore Aqva con alzata Nature

Aqva dispenser with Nature stand
 Distributeur Aqva avec support Nature
 Dispensador Aqva con soporte Nature
 Aqua Getränkespender mit Ständer Nature

	Cm	H Cm	In	H in
305 44 52 711 nero/black	26 x 26	38	10,1/4 x 10,1/4	31,1/2
305 05 52 711 cromato/chromed	26 x 26	38	10,1/4 x 10,1/4	31,1/2



FREDDO

Mantenimento della temperatura delle bevande per 5/6 ore senza bisogno di fonti refrigeranti. Test effettuati ad una temperatura ambiente di 20°C (68°F)

COLD

Maintenance of drinks temperature for 5/6 hours without cooling element. Test carried out at 20°C (68°F) room temperature.

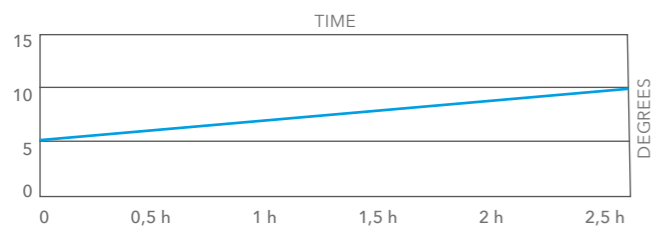

CALDO

Mantenimento della temperatura della bevanda per 4/5 ore senza bisogno di fonti di calore

HOT

Maintenance of drinks temperature for 4/5 hours without heating element.

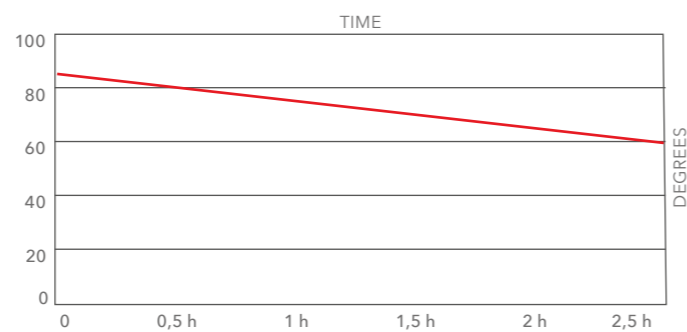

Distributore Aqva con base in noce

Aqva dispenser with walnut wood stand
 Distributeur Aqva avec support en bois de noyer
 Dispensador Aqva con soporte en madera de nogal
 Getränkespender Aqva mit Ständer aus Walnussholz

Noce e vetro - Walnut and glass

	H Cm	H In
305 54 52 728	63	24.8





Distributore Aqva con alzata Classica

Aqva dispenser with Classica stand
 Distributeur Aqva avec support Classica
 Dispensador Aqva con soporte Classica
 Aqua Getränkespender mit Ständer Classica

	Ø Cm	H Cm	Ø In	H In
305 55 52 712	27	80	10,5/8	31,1/2
cromato/chromed				

305 07 52 712	27	80	10,5/8	31,1/2
acciaio argentato/electro-plated stainless steel (EPSS)				



Distributore bevande caldo/freddo

Hot and cold beverage dispenser
 Distributeur de boissons chaud/froid
 Dispensador de bebidas caliente/frío
 Getränkespender warm/kalt

	Lt	Oz	H Cm.	H In
305 05 52 709	5	169	80	31,1/2



Espositore piccola pasticceria

Petits fours display
 Présentoir à petits fours
 Soporte para pasteles
 Ständer für kleine Gebäcke

	Ø mm	H mm	Ø In	H In	Fori/holes
607 N0 71 933	490	423	19,1/4	16,1/2	60
607 P0 68 115	340	300	13,3/8	11,3/4	32
607 P0 68 117	165	145	6,1/2	6,1/2	9



Paletta pasticceria Acciaio Inox

Server for petit fours small St.Steel
 Petite pelle à petits fours Acier Inox
 Pala pequeña para pastelitos Acero Inox
 Gebäckzange, Edelstahl

	Cm	In
3050581708	5	2
3050581711 con piega	3,7 x 9	1,5/8 x 3,1/2



Gennaro





Italo

Cottura - Cooking



Piano a induzione con supporto in acciaio

Induction cooktop with steel countertop
 Plaque à induction avec table de travail en acier
 Placa de inducción con encimera en acero
 Induktionskochplatte mit Arbeitsplatte Edelstahl

Compenso in acciaio

Steel countertop
 Table de travail en acier
 Encimera en acero
 Arbeitsplatte Edelstahl

305 05 52 725 Cm In
 30 x 38,5 23,5/8 x 15,1/8

305 05 52 727 Cm In
 30 x 38,5 11,3/4 x 15,1/8

Mantenimento del calore - Heat-keeping

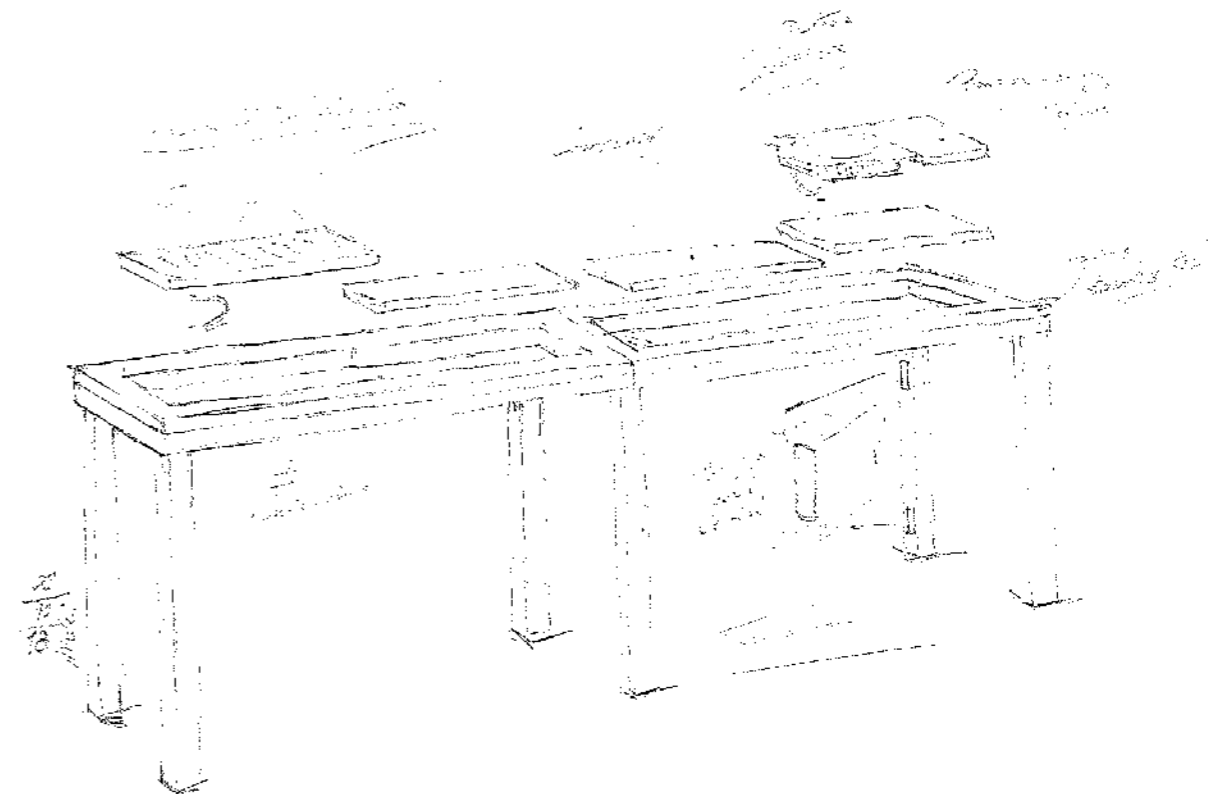



Scaldavivande da incasso con coperchio in acciaio inox

Built-in chafing dish with St. Steel cover
 Chafing dish encastrable avec couvercle en acier inox
 Chafing dish para empotrar con tapa en acero inox
 Chafing Dish zum Einbauen mit Edelstahl Deckel

	Cm	H Cm
GN 1/1		
305 05 52 693	60,5 x 40,5	39,5

Refrigerato / Thermal		
GN 1/1	Cm	H Cm
305 05 52 706	60,5 x 40,5	39,5

Scaldavivande da incasso con coperchio in acciaio inox / vetro

Built-in chafing dish with St. Steel / glass cover
 Chafing dish encastrable avec couvercle en acier inox / verre
 Chafing dish para empotrar con tapa en acero inox / vidrio
 Chafing Dish zum Einbauen mit Edelstahl / Glass Deckel

	Cm	H Cm
GN 1/1		
305 05 52 692	60,5 x 40	39,5

Refrigerato / Thermal		
GN 1/1	Cm	H Cm
305 05 52 705	60,5 x 40	39,5

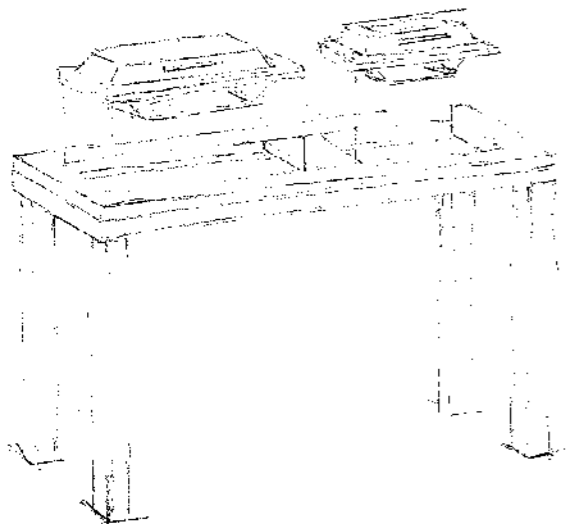

Scaldavivande da incasso con coperchio in acciaio inox

Built-in chafing dish with St. Steel cover
 Chafing dish encastrable avec couvercle en acier inox
 Chafing dish para empotrar con tapa en acero inox
 Chafing Dish zum Einbauen mit Edelstahl Deckel

	Cm	H Cm
GN 2/3		
305 05 52 695	43 x 40	21

Scaldavivande da incasso con coperchio in acciaio inox / vetro

Built-in chafing dish with St. Steel / glass cover
 Chafing dish encastrable avec couvercle en acier inox / verre
 Chafing dish para empotrar con tapa en acero inox / vidrio
 Chafing Dish zum Einbauen mit Edelstahl / Glass Deckel

	Cm	H Cm
GN 2/3		
305 05 52 694	43 x 40	21

Compenso GN 1/3 in laminato

GN 1/3 countertop laminate
 Table de travail GN 1/3 en melamine
 Encimera GN 1/3 en laminado
 Arbeitsplatte GN 1/3

	Cm	In
305 04 51 709	17,6 x 32,5	6,7/8 x 12,3/4





Caratterizzato da un design pulito

e funzionale che lo rende simile a un mobile contemporaneo, il carrello Italo può essere utilizzato come comodo sostegno e mezzo di trasporto per i tavoli opportunamente piegati.

It stands out with a simple design;

trolley Italo can be used as a useful support, as well as a carriage of the tables properly folded.

Il carrello è dotato di 3 scaffali

nei quali riporre i prodotti che successivamente verranno disposti sul tavolo. Una volta svuotato, può essere trasformato in un mobile nel quale collocare ordinatamente le stoviglie; può inoltre essere utilizzato come piano di appoggio aggiuntivo al tavolo. Composto da materiali pregiati: acciaio e legno. È inoltre dotato di 4 ruote in acciaio pivotanti e con freno.

Misure: 115 x 59 x H 89 Cm

The trolley contains accommodations and

sections where one can store the products which, after that, will be placed on the table. Once empty, taking off the dividers, it can be transformed in a piece of furniture in which it is possible to store tableware tidily; also, it can be used as an additional countertop besides the table. Made of high-quality materials: steel and wood.

Size: 115 x 59 x H 89 Cm



Carrello

Trolley
Chariot
Carro
Wagen

	Cm	In
■ 305 04 52 647	115 x 59 H. 89	6,7/8 x 12,3/4



Tavolo 1

Table 1
Table 1
Mesa 1
Tisch 1

	Cm	H Cm	In	H In
■ 305 04 51 651	132 x 65	89	52 x 25,5	35



Tavolo 2

Table 2
Table 2
Mesa 2
Tisch 2

	Cm	H Cm	In	H In
■ 305 04 51 652	264 x 65	89	104 x 25,5	35

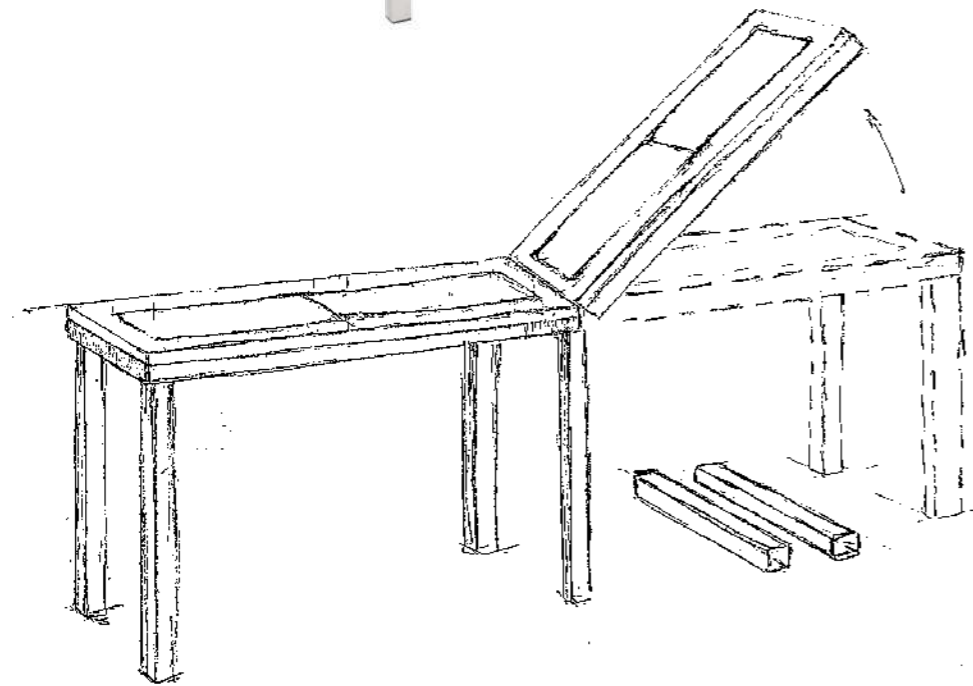

Ogni tavolo È dotato di due compensi in legno removibili, ciascuno dei quali misura 60 x 38,5Cm, in modo da poter allocare all'interno dei tavoli i seguenti accessori:

- Cahafing dish gn 2/3 + compenso legno
- Cahafing dish gn 1/1
- Piano ad induzione
- Piano per il mantenimento del calore

Each table has two removable wood countertops, whose size is 60 x 38,5 Cm, so that inside the tables the following accessories can be fitted:

- GN 2/3 chafing dish+ wood countertop
- GN 1/1 chafing dish
- Induction cooktop
- Top, heat-keeping



Possibilita' di avere una o piu' gambe del tavolo adatte a nascondere i cavi elettrici. Tutte le gambe dei tavoli hanno un aggancio semplificato (attraverso due perni facilmente avvitabili senza alcun utensile).

Possibility of having one or more table legs, suitable for hiding the electric cables. All the table legs have a simple coupling (by two pivots, easily screwable by hand).

Gamba elettrificata su richiesta

- Electric leg
- Jambe électrique
- Pata eléctrica
- Elektrische Beine

B35 05 51 652



I nuovi carrelli PiGreco, con telaio in acciaio inossidabile 18/10 e ripiani in legno verniciato opaco, regalano una vera e propria rivoluzione nel campo del servizio. La presenza di sole due gambe diametralmente opposte permette una facilità di carico fino ad oggi mai sperimentata. Le linee pulite, moderne ed eleganti, il design brevettato, lo stile accattivante e la cura nei minimi dettagli rendono PiGreco unico nel suo genere.

Disponibile nella versione nero opaco o, a richiesta, in legno chiaro naturale; i carrelli a 2 o 3 ripiani sono componibili e personalizzabili grazie alla vasta gamma di accessori.

The new PiGreco trolleys, with stainless steel structure and matte varnished wood tops, represent a real revolution in the service field.

Only two legs, diametrically opposite, allow easy loading, never experienced before. Clean lines, modern and elegant, patented design, appealing style and care of the smallest details, make PiGreco a one of a kind trolley.

It comes in matte black or, upon request, natural light wood; 2-tier and 3-tier trolleys are modular and customizable thanks to a wide accessories range.

Die neuen Wagen PiGreco, mit Edelstahl 18/10

Gestell und die Bretter aus matt lackiertem Holz, stellen eine echte Revolution im Service-Bereich dar.

Nur zwei Beine, diametral entgegengesetzt, erlauben eine leichte Beladung noch nie bis heute erlebt.

Die saubere Linie, modern und elegant, das patentierte Design, ein gewinnendes Stil und eine Pflege in allen Einzelheiten machen PiGreco einzig in seiner Art.

Lieferbar matt schwarz oder, auf Wunsch in natürlichem hellem Holz; die 2- und 3-stufige Wagen sind modular und personell gestaltet dank einer breiten Zubehörpalette.

Les nouveau x chariots PiGreco, avec cadre en acier inox idable 18/10 et étagères en bois laqué opaque, représentent une véritable révolution dans le domaine du service. La présence de deux seuls supports, diamétralement opposés, permet une facilité de charge jamais expérimentée jusqu'aujourd'hui.

Les lignes essentielles, modernes et élégantes, le design breveté, le style charmant et le soigné dans les moindres détails rendent PiGreco unique en son genre.

Disponibile dans la version noir opaque ou, sur la demande, en bois clair naturel; les chariots avec 2 ou 3 étagères sont modulables et personnalisables grâce à la vaste gamme des accessoires.

Los nuevos carros de servicio PiGreco, con estructura en acero inoxidable 18/10 y estantes en madera barnizada opaca, representan una verdadera revolución en el campo del servicio.

La presencia de dos soportes solamente, diametralmente opuestos, permite una facilidad de carga nunca experimentada hasta ahora.

Las líneas limpias, modernas y elegantes, el diseño patentado, el estilo cautivador y el cuidado de los más mínimos detalles hacen PiGreco único en su género.

Disponibile en la versión negro opaco o, a pedido, en madera clara natural; los carros de 2 o 3 niveles son modulares y personalizables gracias a la vasta gama de accesorios.



Carrelli PiGreco

Modern and
stylish structures

Carrello servire 2 ripiani

Service trolley, 2-tier
 Chariot de service 2 étagères
 Carro servizio 2 niveles
 Servierwagen, 2-stufig

	Cm	H Cm	In	H In
319 04 51 681	90 x 50	82	35,3/8 x 19,3/4	32,1/4



Carrello di servizio adeguato a qualsiasi utilizzo. Base a 2 ripiani alla quale si possono abbinare vari componenti per creare il carrello che meglio risponde alle vostre esigenze.

È dotato di ruote antivibrazione, pivotanti, di cui 2 con freno, adatte ad ogni tipo di pavimentazione. L'aspetto estetico, dalle linee pulite allo stile accattivante, rendono PiGreco unico nel suo genere.

Service trolley suitable for every use. A 2-tier base to which you can combine various components to create the trolley that best meets your requirements.

It is equipped with anti-vibration, pivoting wheels, 2 of which with brake. The aesthetic appearance, with clean lines and appealing style make PiGreco a one of a kind trolley.



Poggiapiatto estraibile in legno
 Wood removable tray



Pratica maniglia in acciaio inossidabile
 Stainless steel handles



Ruota pivotante rivestita con gomma antistatica
 Pivoting wheel with anti-static rubber



Carrello servire 3 ripiani

Service trolley, 3-tier
 Chariot de service 3 étagères
 Carro servizio 3 niveles
 Servierwagen, 3-stufig

	Cm	H Cm	In	H In
319 04 51 682	90 x 50	82	35,3/8 x 19,3/4	32,1/4



Carrello di servizio adeguato a qualsiasi utilizzo. Base a 3 ripiani alla quale si possono abbinare vari componenti per creare il carrello che meglio risponde alle vostre esigenze. Le due gambe agli angoli opposti creano uno spazio tale da agevolare la facilità di carico.

Service trolley suitable for any use. A 3-tier base to which you can combine various components to create the trolley that best meets your requirements. The two legs at opposite corners create a space that allow easy loading.



Telaio resistente in acciaio inossidabile
 Resistant stainless steel structure



Ripiani in legno massiccio verniciato
 Varnished solid wood tiers



Facilità di carico
 Easy loading





Top dolci/formaggi refrigerato

Pastry/cheese top, refrigerated
 Etagère à pâtisseries ou fromages réfrigéré
 Bandeja postres o quesos refrigerada
 Kühlauflauf für Kuchen und Käse

	Cm	H Cm	In	H In
319 04 51 683	90 x 50	30	35,3/8 x 19,3/4	11,3/4



Vassoio estraibile in acciaio inossidabile con fori drenaggio condensa
 Stainless steel pull-out tray with holes for condensation



Top flambé a gas

Flambé top, gas
 Etagère flambé à gas
 Bandeja flambeado a gas
 Flambieraufsatz, Gas

	Cm	H Cm	In	H In
319 04 51 684	90 x 50	9,5	35,3/8 x 19,3/4	3,3/4



Top bar con ringhiera

Bar top with railing
 Etagère bar avec rack en acier
 Bandeja bar con barandilla
 Aufsatz für Barservierwagen mit Rand

	Cm	H Cm	In	H In
319 04 51 685	90 x 50	9,5	35,3/8 x 19,3/4	3,3/4
319 04 51 686	70 x 50	9,5	27,1/2 x 19,3/4	3,3/4



Top bar con ringhiera

Bar top with railing
 Etagère bar avec rack en acier
 Bandeja bar con barandilla
 Aufsatz für Barservierwagen mit Rand

	Cm	H Cm	In	H In
319 04 51 687	50 x 50	9,5	19,3/4 x 19,3/4	3,3/4
319 04 51 688	40 x 50	9,5	15,3/4 x 19,3/4	3,34



Vasca ghiaccio

Ice pan
 Bac à glaçons
 Cubeta hielo
 Eisschale

	Cm	H Cm	In	H In
319 04 51 689	20 x 50	9,5	7,7/8 x 19,3/4	3,3/4



(in appoggio sulla ringhiera del top bar)
 (to be placed on the bar top railing)

Tagliere acciaio con portacondimenti

Steel tray with condiment holder.
 Planche perforée acier avec bac condiments
 Planchita perforada acero con porta condimentos
 Edelstahlblech mit Soßenhalter

	Cm	H Cm	In	H In
319 04 51 690	20 x 50	8	7,7/8 x 19,3/4	3,1/8



Portabottiglie 3 posti

Bottle holder, triple
 Porte-bouteilles 3 bouteilles
 Porta botellas 3 botellas
 Flaschenhalter, 3-fach

	Cm	H Cm	In	H In
319 04 51 691	20 x 50	9,5	7,7/8 x 19,3/4	3,3/4



Portaglacette completo 3 posti

Bottle cooler holder, triple
 Support rafraîchisseur à bouteilles 3 bouteilles
 Soporte enfriador botellas 3 enfriadores
 Weinkühlerhalter, 3-fach

	Cm	H Cm	In	H In
319 04 51 692	20 x 50	21,5	7,7/8 x 19,3/4	8,1/2



Supporto per sorbetti 2 posti

Pigreco stand for sherbet pots, double
 Support pour 2 sorbettières
 Soporte para 2 sorbeteras
 Nur Halter für Sorbetshalter 2-fach schwarz

	Cm	H Cm	In	H In
319 04 51 693	20 x 50	19	7,7/8 x 19,3/4	7,1/2



Portasorbetti completo 2 posti

Sherbet pots with stand, double
 Support sorbettières avec 2 sorbettières
 Soporte para sorbeteras con 2 sorbeteras
 Sorbetshalter komplett, 2-fach

	Cm	H Cm	In	H In
319 04 51 694	20 x 50	19	7,7/8 x 19,3/4	7,1/2



Top dolci/formaggi refrigerato

Pastry/cheese top, refrigerated
 Etagère à pâtisseries ou fromages réfrigérée
 Bandeja postres o quesos refrigerada
 Kühlaufsatz für Kuchen und Käse

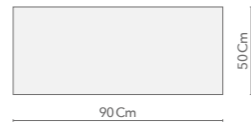

	Cm	H Cm	In	H In
319 04 51 683	90 x 50	30	35,3/8 x 19,3/4	11,3/4



Top bar con ringhiera

Bar top with railing
 Etagère bar avec rack en acier
 Bandeja bar con barandilla
 Aufsatz für Barservierwagen mit Rand



	Cm	H Cm	In	H In
319 04 51 685	90 x 50	9,5	35,3/8 x 19,3/4	3,3/4



Top flambé a gas

Flambé top, gas
 Etagère flambé à gas
 Bandeja flambeado a gas
 Flambieraufsatz, Gas

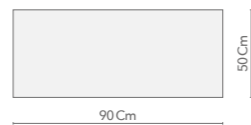

	Cm	H Cm	In	H In
319 04 51 684	90 x 50	9,5	35,3/8 x 19,3/4	3,3/4



	Cm	H Cm	In	H In
A: 2 x 319 04 51 694	20 x 50	19	7,7/8 x 19,3/4	7,1/2
B: 1 x 319 04 51 687	50 x 50	9,5	19,3/4 x 19,3/4	3,3/4

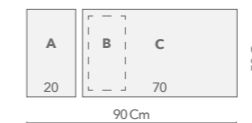

	Cm	H Cm	In	H In
A: 1 x 319 04 51 689	20 x 50	9,5	7,7/8 x 19,3/4	3,3/4
B: 1 x 319 04 51 690	70 x 50	9,5	27,1/2 x 19,3/4	3,3/4
C: 1 x 319 04 51 686	70 x 50	9,5	27,1/2 x 19,3/4	3,3/4

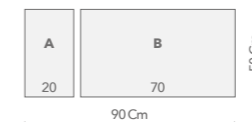

	Cm	H Cm	In	H In
A: 1 x 319 04 51 694	20 x 50	19	7,7/8 x 19,3/4	7,1/2
B: 1 x 319 04 51 686	70 x 50	9,5	27,1/2 x 19,3/4	3,3/4

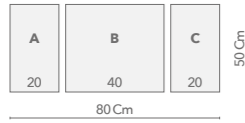

	Cm	H Cm	In	H In
A: 1 x 319 04 51 691	20 x 50	9,5	7,7/8 x 19,3/4	3,3/4
B: 1 x 319 04 51 688	40 x 50	9,5	15,3/4 x 19,3/4	3,3/4
C: 1 x 319 04 51 692	20 x 50	21,5	7,7/8 x 19,3/4	8,1/2

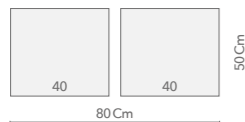

	Cm	H Cm	In	H In
2 x 319 04 51 688	40 x 50	9,5	15,3/4 x 19,3/4	3,3/4

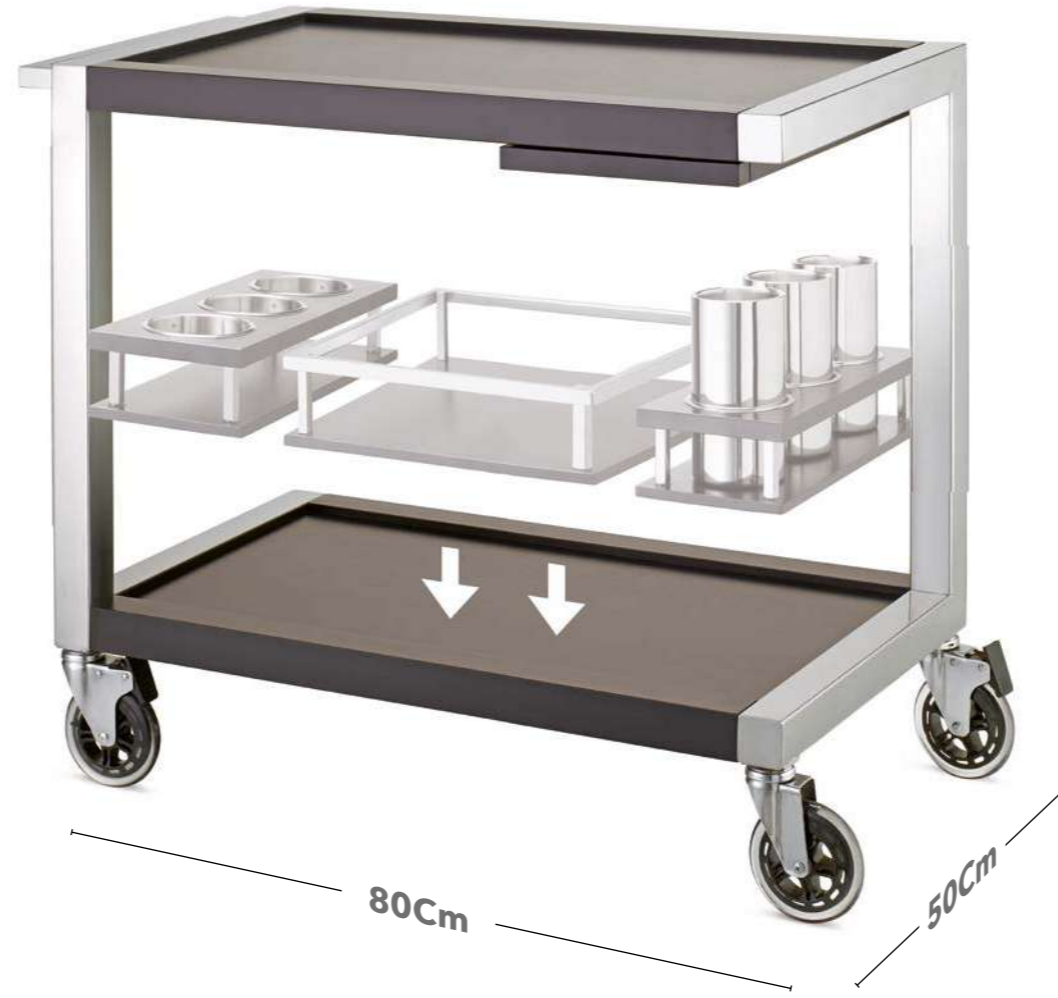

	Cm	H Cm	In	H In
4 x 319 04 51 691	20 x 50	9,5	7,7/8 x 19,3/4	3,3/4

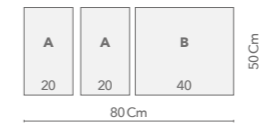

	Cm	H Cm	In	H In
A: 2 x 319 04 51 692	20 x 50	21,5	7,7/8 x 19,3/4	8,1/2
B: 1 x 319 04 51 688	40 x 50	9,5	15,3/4 x 19,3/4	3,3/4

Carrello arrosti

Roast beef trolley
 Table roulante à boeuf
 Carro para carne asada
 Fleischwagen

	Cm	H Cm	In	H In
319 04 51 728	80 x 108	112	31,1/2 x 42,1/2	44,1/8



Carrello bolliti

Boiled meat trolley
 Table roulante à plat du jour
 Carro para cocidos
 Menüwagen

	Cm	H Cm	In	H In
319 04 51 729	60 x 108	112	23,5/8 x 42,1/2	44,1/8



Carrello cocktail

Cocktail trolley
Chariot cocktail
Carro cocktail
Cocktails Servierwagen

	Cm	H Cm	In	H In
319 04 51 699	50 x 90	91,5	35,3/8 x 19,3/4	36

Carrello per il servizio al tavolo ideale per la preparazione di cocktail di ogni tipo. Il carrello è dotato di top in legno con finiture e accessori in acciaio inox lucidato a specchio. Contiene portaglacette, portabottiglie, vasca ghiaccio e tagliere in acciaio con porta condimenti.

Service trolley, perfect to prepare every cocktail. The trolley is provided with wood top with mirror-polished, stainless steel finish and accessories. It comes with bottle cooler holder, bottle holder, ice pan and steel tray with condiment holder.



Tagliere in acciaio con portacondimenti
Steel tray with condiment holder



Portaglacette completo 3 posti
Bottle cooler holder, triple



Portabottiglie 3 posti
Bottle holder, triple



Carrello dolci/formaggi 3 ripiani refrigerato

Trolley for pastry/cheese, 3-tier refrigerated
Chariot pâtisseries/fromages 3 étagères réfrigéré
Carro postres/queso 3 niveles refrigerado
Servierwagen für Käse/Desserts mit Kühlung

	Cm	H Cm	In	H In
319 04 51 695	50 x 90	112	35,3/8 x 19,3/4	45,1/8

Carrello a 3 ripiani per il servizio al tavolo di dolci o formaggi oppure per il servizio a buffet, refrigerato con eutettici. Il carrello è dotato di top in legno con finiture ed accessori in acciaio inox lucidato a specchio.

3-tier service trolley for dessert or cheese or buffet service, with ice-pack cooling. The trolley is provided with wood top with mirror-polished stainless steel finish and accessories.



Vassoio estraibile in acciaio inossidabile con fori drenaggio condensa
Stainless steel pull-out tray with holes for condensation



Top refrigerato con eutettici
Ice-pack cooling top



Vassoio estraibile in acciaio inossidabile con fori drenaggio condensa
Stainless steel pull-out tray with holes for condensation



Poggiapiatto estraibile in legno
Wood removable tray



Carrello bar

Bar trolley
Chariot bar
Carro bar
Bar Servierwagen

	Cm	H Cm	In	H In
319 04 51 697	50 x 90	91,5	35,3/8 x 19,3/4	36

Carrello per il servizio al tavolo di liquori e digestivi. Il carrello è dotato di top in legno con ringhiera in acciaio inox lucidata a specchio.

Service trolley for liquor and drinks. The trolley is provided with wood top with mirror-polished stainless steel railing.



Top bar con ringhiera
Bar top with railing



Pratica maniglia in acciaio inossidabile
Practical stainless steel handle



Ruota pivotante rivestita con gomma antistatica
Pivoting wheel with anti-static rubber



Carrello vini/liquori

Wine/liquor trolley
Chariot vins/liqueurs
Carro vinos/licores
Servierwagen für Likör

	Cm	H Cm	In	H In
319 04 51 698	50 x 90	91,5	35,3/8 x 19,3/4	36

Carrello per il servizio al tavolo di liquori e digestivi. Il carrello è dotato di top in legno con ringhiera in acciaio inox lucidata a specchio. Il carrello include anche porta bottiglie e porta glacette.

Service trolley for liquor and drinks. The trolley is provided with wood top with mirror-polished stainless steel railing. It also comes with bottle holder and bottle cooler holder.



Top bar con ringhiera
Bar top with railing



Portaglacette completo 3 posti
Bottle cooler holder, triple



Portabottiglie 3 posti
Bottle holder, triple



Carrello sorbetti

Sherbet trolley
Chariot sorbets
Carro sorbetes
Servierwagen mit Etagen für Speiseeis und Sorbett

	Cm	H Cm	In	H In
319 04 51 700	50 x 90	101	35,3/8 x 19,3/4	39,3/4

Carrello per il servizio al tavolo di gelato e sorbetti. Il carrello è dotato di top in legno con finiture ed accessori in acciaio inox lucidato a specchio. La sorbettiera è isoterma, a doppio corpo.

Service trolley for ice creams and sherbets. The trolley is provided with wood top with mirror-polished stainless steel finish and accessories. The sherbet pot is isothermal, double-wall.



Top bar con ringhiera
Bar top with railing



Portasorbettiere completo 2 posti
Sherbet pots with stand, double



Facilità di carico
Easy loading



Carrello flambé

Flambé trolley
Chariot flambé
Carro flameado
Flambierwagen

	Cm	H Cm	In	H In
319 04 51 696	50 x 90	91,5	35,3/8 x 19,3/4	36

Carrello per il servizio al tavolo. Il piano di lavoro è in acciaio inox. Il piano di servizio inferiore ha un portabottiglie laterale con finiture in acciaio inossidabile. Il fornello sul piano superiore, con dispositivo di accensione e regolatore manuale di fiamma, è l'ideale per preparare un perfetto flambé.

Flambé service trolley. The working top is stainless steel. The lower service top has a side bottle opener with stainless steel finish. The burner on the upper top, with ignition device and flame adjuster, is the ideal to prepare a perfect flambé!



Fuoco con regolatore di fiamma
Flambé top



Piano in acciaio Inox
Stainless steel tier



Portabottiglie 3 posti
Bottle holder, triple



Carrelli Linea



Carrello Gueridon Linea

Linea gueridon trolley
 Chariot Gueridon Linea
 Carro Gueridon Lineay
 Linea Gueridon-Wagen

	Cm	H Cm	In	H In
327 18 51 001	70 x 35	73	27,1/2 x 13,3/4	28,3/4



Top Bar Linea

Linea bar top
 Dessus à bar Linea
 Encimera bar Linea
 Linea-Baroberteil

	Cm	In
327 18 51 010	70 x 35	27,1/2 x 13,3/4
327 18 51 011	80 x 50	31,1/2 x 19,3/4



Top Pane Linea

Linea bread top
 Dessus à pain Linea
 Encimera pan Linea
 Linea Brotaufsatz

	Cm	In
327 05 51 012	70 x 35	27,1/2 x 13,3/4



Carrello Gueridon Linea

Linea gueridon trolley
 Chariot Gueridon Linea
 Carro Gueridon Lineay
 Linea Gueridon-Wagen

	Cm	H Cm	In	H In
327 18 51 002	80 x 50	82	31,1/2 x 19,3/4	32,1/4



Top Dolci Linea

Linea dessert top
 Dessus à dessert Linea
 Encimera postres Linea
 Linea Dessertaufsatz

	Cm	In
327 05 51 013	70 x 35	27,1/2 x 13,3/4



Carrello completo pane

Complete trolley for bread
 Chariot complet à pain
 Carro completo pan
 Kompletter Servierwagen für Brot

	Cm	In
327 18 51 031	70 x 35	27,1/2 x 13,3/4

**Carrello completo bar**

Complete trolley for bar service
 Chariot complet à bar
 Carro completo bar
 Kompletter Servierwagen für den Barservice

	Cm	In
327 18 51 030	70 x 35	27,1/2 x 13,3/4
327 18 51 040	80 x 50	31,1/2 x 19,3/4

**Carrello completo dolci/formaggi**

Complete trolley for dessert/cheese
 Chariot complet à dessert/fromages
 Carro completo postres/quesos
 Kompletter Servierwagen für Dessert & Käse

	Cm	In
327 18 51 032	70 x 35	27,1/2 x 13,3/4

I carrelli della linea Classica di Broggi sono realizzati in legno massello di faggio verniciato con tinta a base di acqua nel rispetto della normativa europea in materia di idoneità al contatto con gli alimenti. La struttura del carrello, monoblocco ed autoportante, è molto robusta. La lavorazione artigianale è effettuata con l'utilizzo di macchine CNC e le parti metalliche sono realizzate in acciaio inossidabile AISI 304. Tutta la gamma è fornita nella classica ed elegante colorazione mogano Broggi. Hanno 4 ruote pivotanti da 125 mm di diametro con freno di stazionamento meccanico e rivestimento in silicone morbido ed adatte a superare le asperità del pavimento. È possibile produrre versioni in colori speciali su richiesta del cliente con un sovrapprezzo da stabilire. Altrettanto su richiesta del cliente è possibile realizzare versioni speciali dei carrelli con funzioni diverse. Ogni carrello è fornito di imballo singolo e pallettizzato.

Classica trolleys by Broggi are made from solid beechwood, varnished using water-based paints in accordance with European regulations on suitability for food contact. The freestanding, one-piece frame of the trolley is very sturdy. CNC machines are used for a careful manufacturing process and metal parts are made of AISI 304 stainless steel. The entire range comes in the classic and elegant Broggi mahogany colour. The trolley features four Ø125-mm swivel casters plus mechanical brake and a soft silicone coating, suitable to adjust to uneven and rugged floors. Upon request trolleys in special colours can be made at a surcharge to be defined. Special trolley versions featuring different functions can also be made upon request. Each trolley is delivered in a single package and palletised.

Die Servierwagen der Linie Classica von Broggi sind aus massivem Buchenholz, lackiert mit Farblack auf Wasserbasis nach den Vorgaben der europäischen Richtlinie für Gegenstände, die mit Lebensmitteln in Berührung kommen. Der Servierwagen zeichnet sich durch eine sehr robuste, selbsttragende Blockstruktur aus. Die handwerkliche Fertigung erfolgt unter dem Einsatz von CNC Maschinen, die Metallteile sind aus rostfreiem Stahl AISI 304. Die gesamte Serie steht im klassisch eleganten Farbton Mahagoni Broggi zur Verfügung. Der Wagen hat 4 Drehräder von 125 mm Durchmesser mit mechanischer Feststellbremse und weicher Silikonbeschichtung, die für alle Arten von Fußböden geeignet ist. Nach Kundenwunsch können Ausführungen in anderen Farben gegen Aufschlag nach Vereinbarung hergestellt werden. Außerdem sind spezielle Kundenanfertigungen von Servierwagen mit verschiedenen Funktionen möglich. Jeder Wagen wird einzeln verpackt auf Paletten geliefert.

Les chariots de la ligne Classica de Broggi sont réalisés en bois de hêtre verni avec une peinture à base d'eau en conformité avec la réglementation européenne en matière d'aptitude au contact avec les aliments. La structure du chariot, monobloc et autoportante, est très solide. Le travail artisanal est effectué à l'aide de machines CNC et les pièces métalliques sont réalisées en acier inox AISI 304. Toute la gamme est fournie dans la classique et élégante couleur acajou Broggi. Ils ont 4 roues pivotantes de 125 mm de diamètre avec frein de stationnement mécanique et revêtement en silicone souple et appropriées pour surmonter les aspérités du plancher. Il est possible de produire des versions dans des couleurs spéciales à la demande du client avec un supplément à fixer. Toujours à la demande du client, il est possible de réaliser des versions spéciales des chariots avec des fonctions différentes. Chaque chariot est équipé d'emballage individuel et palettisé.

Los carros de la línea Classica de Broggi son elaborados con madera maciza de haya barnizada con tinte a base de agua en el respeto de la normativa europea en materia de idoneidad para el contacto con los alimentos. La estructura del carro, monoblock y autoportante, es muy robusta. La elaboración artesanal se efectúa con el empleo de máquinas CNC y las partes metálicas son realizadas con acero inoxidable AISI 304. Toda la gama es suministrada en la clásica y elegante tonalidad caoba Broggi. Tienen 4 ruedas pivotantes de 125 mm de diámetro con freno de estacionamiento mecánico y revestimiento de silicona blanda adecuadas para superar las asperezas del piso. Es posible producir versiones de colores especiales a solicitud del cliente con un sobrepeso a establecer. Igualmente a solicitud del cliente es posible realizar versiones especiales de los carros con funciones diversas. Cada carro está dotado de embalaje singular y paletizado.

Carrelli Classica



Carrello bolliti e arrosti

Roast beef and boiled meet trolley
 Table roulante à boeuf et plat du jour
 Carro para carne asada y cocidos
 Fleisch-Menüwagen



Carrello per servire al tavolo i bolliti, con due portavivande grandi e uno più stretto, che possono essere regolabili in altezza e consentono di tagliare i bolliti senza toglierli dalla vasca.

Trolley to serve boiled meat, with two big food pans and a narrow one that can be adjusted in height, allowing to cut the meat without taking it out from the pan.

Carrello arrosti composto da tagliere in corian e due contenitori per salsa 14 x 14 Cm H. 12 Cm.

Roast beef trolley composed of corian carving board and two sauce container 14 x 14 Cm H. 12 Cm.

Poggiapiatto ribaltabile in acciaio inossidabile
 Stainless steel plate stand, folding



Termostato regolabile e termometro digitale
 Adjustable thermostat and digital thermometer



Supporto portacoltelli estraibile
 Pull-out knife holder



Carrello arrosti

Roast beef trolley
 Table roulante à boeuf
 Carro para carne asada
 Fleischwagen

318 04 51 528	Cm	H Cm
	96 x 58	97
	In	H In
	37,7/8 x 22,7/8	38,1/4



Carrello bolliti

Boiled meat trolley
 Table roulante à plat du jour
 Carro para cocidos
 Menüwagen

318 04 51 522	Cm	H Cm
	96 x 58	97
	In	H In
	37,7/8 x 22,7/8	38,1/4

Carrello refrigerato ventilato

Ventilated refrigerated trolley
 Table roulante réfrigérée ventilée
 Carro refrigerado ventilado
 Wagen, mit Gelüfteter Kühlung

318 04 51 581 Refrigerato / Refrigerated

Cm	H Cm	In	H In
92 x 52	105	43,1,1/4 x 23,5/8	43,114

Struttura in legno massello con piani impiallacciati. Vasca in acciaio inox AISI 304, dimensioni mm 700 x 395 x 90h. Foro sul fondo vasca per scarico condensa. Rubinetto per scarico acqua. Cupola in plexiglass semicilindrica con apertura su due lati. Pannello comandi con termostato digitale ed interruttore di accensione con spia luminosa. Tensione rete 230 Volt monofase 50/60hz. Cavo elettrico spiralato. Potenza 152 W. Temperatura di esercizio compresa tra 4°C e 10°C. Condensatore 3W. Ruote pivotanti mm 125 di cui due con freno. Dimensioni massime Cm 92 x 52 x 105h.

Solid wood structure with veneer decks AISI 304 stainless steel pan with dimensions mm 700 x 395 x 90h. Condense outlet hole on the bottom. Water outlet tap. Plexiglass semi-cylindrical dome cover with opening on two sides. Operation panel with digital thermostat and power switch with indicator light. 230 Volt voltage, single phase 50/60hz Electric spiral cable. Power 152 W. Operating temperature between 4°C and 10°C. 3W evaporator. Pivoting wheels mm 125, with two brakes. Maximum dimensions Cm 92 x 52 x 105h.



Piano d'appoggio estraibile
 Pull-out top deck



Bordo metallico antiurto
 Shockproof metal edge



Cloche in plexiglass a due elementi semicirculari rientranti
 Plexiglass dome with two semicircular re-entering elements



Apribile su ambo i lati
 Opening in both directions

Carrello flambé a gas

Flambé trolley
 Table roulante à flambée
 Carro para flameado
 Flambierwagen

318 04 51 539

Cm	H Cm	In	H In
90 x 52	90	35,3/8 x 20,1/2	35,3/8

Carrello per il servizio del flambé al tavolo. Il piano di lavoro è in corian. Il piano di servizio inferiore ha una ringhiera di protezione ed è presente un portabottiglie laterale in acciaio inossidabile. Il fornello ha la griglia asportabile ed il bruciatore ha un dispositivo di sicurezza termocoppia secondo la normativa CE, vano portabombola in legno, dispositivo di accensione piezoelettrico e regolatore di fiamma. È disponibile in legno color ebano.

Flambé service trolley. The working deck is corian. The service lower deck has a protective barrier and a side stainless steel bottle holder. The stove has a removable grate and the burner has a thermocouple security device complying with CE regulations, a wooden gas cylinder cabinet, a piezoelectric ignition device and a flame adjuster. It is available in ebony colour wood.



Cestello porta bottiglie / spezie in acciaio inossidabile
 Stainless steel bottle / spice holder



Fuoco con griglia asportabile
 Stove with removable grate



Dispositivo di accensione piezoelettrico e regolatore di fiamma
 Piezoelectric ignition device and flame adjuster



Carrello Omicron

Omicron trolley
Table roulante Omicron
Carro Omicron
Omicron Servierwagen

	Cm	H Cm	In	H In
318 04 51 680	92 x 52	120	36,1/4 x 20,1/2	47,1/4

Carrello per il servizio di dolci o formaggi. L'estrema maneggevolezza e le dimensioni contenute rendono il carrello adatto al servizio tra i tavoli. Cloche in plexiglass con apertura bilaterale. Il piano, refrigerato con piastre eutectiche, è ad avanzamento automatico con apertura cloche. Ruote pivotanti di cui due con freno.

Cheese and dessert trolley
Extreme manageability and small dimensions make it ideal for table service. Plexiglass cloche with two sides opening. The top, refrigerated with ice packs, slides automatically by opening the cloche. Pivoting wheels, two of which with brake with barrier.



Maniglia in acciaio inox
Stainless steel handle



Piano ad avanzamento automatico
Automatic sliding top



Piano refrigerato con piastre eutettiche
Top refrigerated with ice packs



Vassoio estraibile in acciaio inossidabile con fori drenaggio condensa
Stainless steel pull-out tray with holes for condensation



Carrello Sigari

Cigar trolley
Chariot à cigares
Carro de servicio para puros
Servierwagen mit Zigarrenhalter

	Cm	H Cm	In	H In
318 04 51 678	92 x 52	98	36,1/4 x 20,1/2	32,1/4

Con alzata liquori	Cm	H Cm	In	H In
318 04 51 679	92 x 52	125	36,1/4 x 20,1/2	49,1/4

Carrello per il servizio di sigari. Cassetta sigari umidificata, realizzata in legno di cedro, vetrine in vetro con chiusura di sicurezza, umidificatore professionale, igrometro analogico per il controllo dell'umidità. Il carrello, con l'aggiunta del top bar/liquori e alzata per calici, diventa l'ideale anche per il servizio di liquori. Ruote pivotanti di cui due con freno.

Cigar trolley.
Cigar humidifier box, cedar wood, glass windows with safety lock, analog hygrometer for humidity control. The trolley, with the bar/liqueur top and the goblet top, is the ideal for liqueur service. Pivoting wheels, two of which with brake.

Cassette sigari umidificate in legno di cedro
Cigar humidifier box es, cedar wood



Igrometro analogico per il controllo dell'umidità
Analog hygrometer for humidity control



Vetrine con chiusure di sicurezza
Glass windows with safety lock



Carrello servire champagne tondo

Round champagne service trolley
 Table roulante de service à champagne
 Carro de servicio para champán
 Servierwagen für Champagne, rund

	Ø Cm	H Cm	Ø In	H In
318 04 51 717	83	83	32,3/4	32,3/4

Coppa champagne Rubans non inclusa
 Punch baul not included

Coppa punch con manici Rubans

Punch bowl with Rubans handles
 Bol à punch avec poignées Rubans
 Champañera con asas Rubans
 Punschschale mit Griff Rubans

	Ø Cm	Lt	Ø In	Oz
310 00 43 602	50	30	19,3/4	1014

Carrello tondo per il servizio di champagne di ø 83 cm. Il carrello ha 16 fori per bicchieri del ø di 9 cm e lo spazio per posizionare una coppa champagne. Ideale per il servizio al tavolo di champagne e non solo. Ruote pivotanti di cui due con freno.

Round champagne trolley, ø 83 cm. The trolley has 16 holes for glasses, ø 9 cm, and room for a champagne bowl. Ideal for table service of champagne and more. Pivoting wheels, two of which with brake.



Coppa champagne Rubans Ø Cm50
 Rubans champagne bowl, Ø Cm50



Piano di servizio inferiore con ringhiera di protezione
 Lower service deck with protective barrier



Sede alloggio bicchieri
 Champagne glass seat



Carrello tondo Liquori

Liquor trolley, round
 Chariot rond à liqueurs
 Carro redondo licores
 Spirituosenwagen, rund

	Cm	H Cm	In	H In
318 04 51 717	83	83	32,7	32,7



Bordo metallico antiurto
 Shock proof metal edge



Piano d'appoggio estraibile
 Pull-out top deck



Piano di servizio inferiore con ringhiera di protezione
 Lower service deck with protective barrier



Carrello servire

Service trolley
Table roulante de service
Carro de servicio
Servierwagen

	Cm	H Cm	In	H In
318 04 51 519	92 x 52	98	36,1/4 x 20,1/2	32,1/4

Carrello di servizio, funzionale per tutti gli utilizzi. È in legno color ebano e può essere dotato di tops diversi, specifici per l'uso. Il carrello servire può diventare carrello per presentazione del pesce, carrello bar liquori, carrello dolci e formaggi refrigerato, carrello per insalata ed antipasti, carrello per gelati e sorbetti.

Service trolley, functional for all uses. It is in ebony colour wood, and can be provided with different specific tops. The service trolley can be a fish display trolley, a liquor trolley, a refrigerated trolley for pastry and cheese, a salad and hors d'oeuvre trolley, or an ice-cream and sherbet trolley.



Maniglie in acciaio inox
Stainless steel handles



Ruota pivotante rivestita con gomma antistatica
Pivoting wheel with anti-static rubber tyre



Piano di servizio inferiore con ringhiera di protezione
Lower service deck with protective barrier



Carrello servire 3 piani

Service trolley, 3-tier
Chariot de service 3 étagères
Carro servicio 3 niveles
Servierwagen, 3-stufig

	Cm	H Cm	In	H In
318 04 51 646	92 x 52	98	36,1/4 x 20,1/2	32,1/4

Il nuovo carrello di servizio con tre ripiani, funzionale per tutti gli utilizzi. È in legno color ebano e può essere dotato di tops diversi, specifici per l'uso.

The new 3-shelves service trolley, functional for all uses. It is in ebony colour wood, and can be provided with different specific tops.



Bordo metallico antiurto
Shock proof metal edge



Piano d'appoggio estraibile
Pull-out top deck



Piano di servizio inferiore con ringhiera di protezione
Lower service deck with protective barrier





Top bar / liquori con alzata per calici per carrello servire

Service trolley liquor top with goblet stand

	Cm	H Cm	In	H In
318 04 51 526	84 x 45	46	33 x 17,3/4	18,1/8



Top bar / liquori per carrello servire

Service trolley liquor top

	Cm	In
318 04 51 520	84 x 45	33 x 17,3/4



Top gelati e sorbetti per carrello servire

Service trolley ice-cream and sherbet top

	Cm	In
318 04 51 542	84 x 45	33 x 17,3/4



Top servire liquori

Liquor service top

	Cm	In
318 04 51 705	84 x 45	33 x 17,3/4 in



Carrello servire

Service trolley with pull-out top deck

	Cm	H Cm	In	H In
318 04 51 519	92 x 52	82	36,1/4 x 20,1/2	32,1/4



Top refrigerato per presentazione pesce per carrello servire

Service trolley refrigerated top for fish display

	Cm	In
318 04 51 543	84 x 45	33 x 17,3/4



Top dolci e formaggi refrigerato per carrello servire

Service trolley refrigerated top for pastry and cheese

	Cm	H Cm	In	H In
318 04 51 521	79 x 44	29	31,1/8 x 17,3/8	11,1/2



Top pasticceria 2 piani refrigerato per carrello servire

Dessert refrigerated top for service trolley, 2-tier

	Cm	H Cm	In	H In
318 04 51 675	76 x 42	52	30 x 16,1/2	20,1/2



Carrello servire 3 piani

Service trolley with pull-out top deck

	Cm	H Cm	In	H In
318 04 51 646	92 x 52	82	36,1/4 x 20,1/2	32,1/4

Carrello servire pasticceria/formaggi

Service trolley with refrigerated top for cheese
 Table roulante de service avec étagère à fromages réfrigérée
 Carro de servicio con bandeja para quesos refrigerante
 Servierwagen mit Etage für Käse mit Kühlung

318 04 51 547 Refrigerato / Refrigerated

Cm	H Cm	In	H In
92 x 52	112	36,1/4 x 20,1/2	44

Carrello per il servizio al tavolo di dolci o formaggi oppure per il servizio a buffet, refrigerato con eutettici. Il carrello è dotato di top in legno color ebano con finiture e accessori in acciaio inox lucidato a specchio.

Service trolley for cheese and pastry or buffet service, with ice-pack cooling. The trolley is provided with an ebony colour top, with mirror-polished stainless steel finishing and accessories.



Carrello servire con top gelati e sorbetti

Service trolley with ice-cream and sherbet top
 Table roulante de service avec étagère à glaces et sorbets
 Carro de servicio con bandeja para helados y sorbetes
 Servierwagen mit Etage für Speiseeis und Sorbett

318 04 51 549

Cm	H Cm	In	H In
92 x 52	120	36,1/4 x 20,1/2	47,1/4

Carrello per il servizio al tavolo di gelato e sorbetti. Il carrello è dotato di top in legno color ebano con finiture e accessori in acciaio inossidabile lucidato a specchio. La sorbettiera è isoterma, a doppio corpo.

Service trolley for ice-creams and sherbets. The trolley is provided with ebony colour wooden top, mirror-polished stainless steel finishing and accessories. The sherbet pot is isothermal, double-wall.



Piano d'appoggio estraibile
Pull-out top deck



Set dolci e formaggi
Pastry and cheese set



Vassoio estraibile in acciaio inossidabile con fori drenaggio condensa
Stainless steel pull-out tray with holes for condensation



Sorbettiera isoterma
Isothermal sherbet pot



Piano con 4 sorbettiere
Deck with 4 sherbet pots



Piano d'appoggio estraibile
Pull-out top deck



Carrello servire con top refrigerato per presentazione pesce

Service trolley with refrigerated top for fish display
 Table roulante de service avec étagère réfrigérée à poisson
 Carro de servicio con bandeja refrigerante para pescado
 Servierwagen mit Etage für Fisch mit Kühlung

	Cm	H Cm	In	H In
318 04 51 544	92 x 52	85	36,1/4 x 20,1/2	33,1/2

Carrello per la presentazione del pesce fresco, refrigerato direttamente con ghiaccio. Il carrello è dotato di top in legno color ebano e di piano inferiore con ringhiera.

Trolley for fresh fish display with ice cooling. The trolley is provided with ebony colour wooden top and lower deck with barrier.



Vasca estraibile in acciaio
Pull-out stainless steel pan



Piano d'appoggio estraibile
Pull-out top deck



Refrigerazione con ghiaccio
Ice cooling



Carrello servire con top bar / liquori e alzata per calici

Service trolley with liquor top and goblet stand
 Table roulante de service avec étagère à liqueurs et tablette pour verres à pied
 Carro de servicio con bandeja para licores y bandejita para copas
 Servierwagen mit Etage für Likör und Gläser

	Cm	H Cm	In	H In
318 04 51 546	92 x 52	127	36,1/4 x 20,1/2	50

Carrello per il servizio al tavolo di liquori e digestivi. Il carrello è dotato di top in legno color ebano con finiture e accessori in acciaio inox lucidato a specchio. Pratico anche nella versione con l'alzata per calici con ringhiera di protezione.

Service trolley for liquor and digestives. The trolley is provided with ebony colour wooden top, mirror-polished stainless steel finishing and accessories. It is practical also in its version with the goblet stand with protective barrier. It is practical also in its version with the goblet stand with protective barrier.



Alzata per calici con ringhiera di protezione
Goblet stand with protective barrier



Ancoraggio a rotaia per calici
Rail fixing for goblets



Ruota pivotante rivestita con gommaantistatica
Pivoting wheel with anti-static rubber tyre



Carrello servire con top bar

LiquoriService trolley with liquor top
 Table roulante de service avec étagère à liqueurs
 Carro de servicio con bandeja para licores
 Servierwagen mit Etage für Likör

	Cm	H Cm	In	H In
318 04 51 545	92 x 52	100	36,1/4 x 20,1/2	39,1/2

Carrello per il servizio al tavolo di liquori e digestivi. Il carrello è dotato di top in legno color ebano con finiture e accessori in acciaio inox lucidato a specchio.

Service trolley for liquor and digestives. The trolley is provided with ebony colour wooden top, mirror-polished stainless steel finishing and accessories.



Piano di servizio inferiore
 Lower service deck



Piano d'appoggio estraibile
 Pull-out top deck



Ringhiera di protezione superiore e maniglie in acciaio inox
 Top deck protective barrier with stainless steel handles



Carrello Gueridon lusso

Gueridon trolley, de lu x e
 Table roulante guéridon de lu x e
 Carro queridon lujo
 Gueridonwagen De Lu x e

	Cm	H Cm	In	H In
318 04 51 524	78 x 48	80	30,3/4 x 19	31,1/2
318 04 51 662	70 x 35	74	27,1/2 x 13,3/4	29,1
318 04 51 661	50 x 35	74	27,1/2 x 13,3/4	29,1

Carrello per il servizio al tavolo di dolci, pesce o formaggi, oppure per il servizio a buffet.

Service trolley for pastry, fish, cheese or buffet.



Gamba sagomata de lu x e
 De lu x e shaped leg



Piano inferiore con bordo
 Lower deck with edge



Ruota pivotante rivestita con gomma antistatica
 Pivoting wheel with anti-static rubber tyre



Gamma colori

I carrelli Broggi possono essere prodotti, oltre che nel tradizionale color ebano, anche in alcuni colori speciali, come raffigurato nella tabella sottostante.

IMPORTANTE

Essendo il legno un prodotto naturale, i colori qui riprodotti sono indicativi. I nostri prodotti potrebbero essere soggetti a piccole variazioni di colore, lucentezza o intensità di venature che rientrano nella tolleranza. Eventuali differenze cromatiche rispetto ai campioni o a precedenti spedizioni non costituiscono quindi motivo di reclamo.

Colour range

In addition to the traditional ebony colour, Broggi trolleys can be also manufactured in some special colours, as shown in the table.

IMPORTANT

Being wood a natural product, the colours shown here are indicative only. Our products could have slight colour, brightness or intensity grain variations, within tolerance limits. Possible colour differences in comparison with samples or previous shipments are not reasons for claim.

Gamme de couleurs

Les tables roulantes Broggi peuvent être produits, en plus que dans la couleur ébène traditionnelle, aussi dans quelques couleurs spéciales, représentées dans le tableau.

IMPORTANT

Puisque le bois est un produit naturel, les couleurs reproduites ici sont indicatives. Nos produits pourraient être sujets à des petites variations dans la couleur, dans le brillant où dans l'intensité des veinures qui rentrent dans la tolérance. D'éventuelles différences chromatiques en ce qui concerne les échantillons où les livraisons précédentes ne constituent donc pas une raison de réclamation valable.

Gama de colores

Los carros Broggi pueden ser producidos, además de en el tradicional color ébano, en algunos colores especiales también, como ilustrado en la tabla.

IMPORTANTE

Siendo la madera un producto natural, los colores aquí reproducidos son indicativos. Nuestros productos podrían tener pequeñas variaciones de color, brillo o intensidad de veta en los límites de tolerancia. Eventuales diferencias cromáticas con las muestras o las expediciones anteriores no constituyen motivos de reclamación

Farben

Unsere Mehrzweckwagen werden nicht nur in Ebenholz sondern auch in Sonderfarben produziert (Tabelle).

WICHTIG

Die abgebildeten Farben sind unverbindlich; Holz ist ein Naturprodukt. Unregelmässigkeiten in Farbe und Masserung sind ein Zeichen dafür. Gebeizte Oberflächen können in Farbe und Glanzgrad von Farbmustern oder früheren Lieferungen abweichen. Dies ist kein Reklamationsgrund.

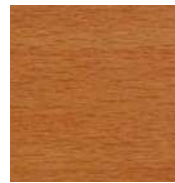

Cod. 51 Mogano chiaro

Light mahogany
Acajou clair
Caoba claro
Mahogany hell



Cod. 52 Mogano

Mahogany
Acajou
Caoba
Mahogany

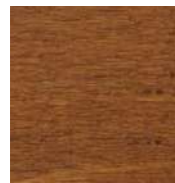

Cod. 54 Noce scuro

Dark walnut
Noyer foncé
Nogal oscuro
Nuss dunkel



Cod. 55 Palissandro

Rosewood
Palissandre
Palisandro
Palisander

Manutenzione Wood

Wood Maintenance

MANUTENZIONE ARTICOLI IN LEGNO

Il legno è un materiale naturale e vivo, per questo è un'ottima materia prima per arredi, complementi e oggettistica.

Garantisce solidità, sicurezza e durata negli anni ma richiede anche interventi di manutenzione per conservare tutte le sue caratteristiche.

Esistono prodotti specifici per pulire e proteggere il legno nel rispetto della naturalezza di questo nobile materiale.

Come togliere i graffi dal legno:

In commercio esistono molti prodotti adatti per rimuovere i graffi dal legno come lucidanti pigmentati per mobili, applicabili con un panno pulito.

Per graffi particolarmente lievi o bordi sciupati è possibile usare dei markers per il ritocco che riescono a coprire graffi e segni di usura.

Per graffi più profondi è possibile usare una stecca di cera (del colore compatibile a quella del legno da riparare).

WOOD PRODUCTS MAINTENANCE

Wood is a natural and live material, consequently, it is an excellent raw material for furniture, accessories and objects.

It guarantees solidity, safety and durability over the years, however, it also requires maintenance in order to preserve all its characteristics.

There are specific products to clean and protect wood, respecting the naturalness of this noble material.

How to remove scratches from wood:

In the market there are many products suitable for removing scratches from wood like pigmented polishes, which can be applied with a clean cloth.

For light scratches or worn edges you can use touch-up markers, which can cover scratches and signs of wear.

For deep scratches you can use a wax stick (of colour compatible with the wood that needs repair).

Manutenzione PVD

PVD Maintenance

ISTRUZIONI D'USO E DI MANUTENZIONE PER LA POSATERIA ED IL VASELLAME IN PVD

Lavare accuratamente i prodotti prima di utilizzarli per la prima volta.

Dopo ogni utilizzo evitare di lasciare per tempi prolungati gli articoli sporchi a contatto con i residui alimentari e/o immersi nel liquido di rigoverno. Alcune sostanze contenute negli alimenti sono infatti dannose per il PVD e ne alterano l'aspetto. È quindi importante lavare gli articoli utilizzati subito dopo l'uso.

In caso di lavaggio manuale utilizzare acqua calda e sapone neutro, risciacquare con abbondante acqua tiepida ed asciugare scrupolosamente tutti gli articoli dopo il lavaggio per evitare la formazione di macchie dovute a depositi calcarei contenuti nell'acqua. Evitare tassativamente l'utilizzo di pomice, paglietta d'acciaio, spugnette o panni impregnati di polveri abrasive.

In caso di lavaggio in lavastoviglie utilizzare un programma a temperatura non superiore a 60°C. Tenere separati i coltelli dalle altre posate (forchette e cucchiai) e da altri articoli in acciaio inox. Escludere detersivi sintetici a base di cloro e con fosfati superiori al 10%, ossigeno o prodotti comunque candeggianti. È consigliabile estrarre ed asciugare accuratamente con un panno morbido tutti i pezzi subito dopo il lavaggio, anche se comprende un ciclo di asciugatura automatica. Non lasciare le posate e gli articoli in PVD nell'ambiente umido della lavastoviglie ma asciugarli e riporli in un ambiente asciutto.

Evitare di sottoporre i pezzi trattati in PVD a operazioni di pulizia o asciugatura utilizzando asciugatori o lucidatori automatici con azione di granuli, ceramici o paste/liquidi abrasivi. Possono essere invece utilizzati il tutolo di mais o detersivi non clorurati contenenti farina fossile.

Non utilizzare lavastoviglie a osmosi.

In caso di leggero viraggio del colore o macchie calcaree persistenti pulire con panno morbido e aceto e successivamente risciacquare con abbondante acqua tiepida e asciugare accuratamente.

PVD CUTLERY AND PLATE INSTRUCCION OF USE AND MAINTENANCE

Wash up carefully the PVD items before their first use.

Do not leave for a long time the dirty items in contact with alimentary residues and/or immersed all together in the washing water. Some substances contained in the aliments are in fact harmful for PVD and could alter its surface aspect. So it's very important to wash up all articles immediately after their use.

In case of hand wash use hot water and a good neutral detergent to wash them up; later on rinse out with abundant tepid water and meticulously dry all articles after the washing to avoid eventually forming of stains of limestone contained in the water. Pumice, steel wool, sponge or cloth saturated with abrasive powder have to be strictly excluded.

In case of wash with dishwasher use a washing program at temperature not higher than 60°C. Take knives separated from other cutlery (forks and spoons) and other stainless steel kitchenware. Do not use to wash any synthetic detergents at chlorine and with phosphates in % more than 10%, oxygen base or similar detergents bleaching. Remove and dry meticulously all cutlery after the washing with a soft cloth, even if the dishwasher has a cycle of automatic drying (this is to remove to surface of cutlery any limestone stains). Do not leave cutlery in the humidity of dishwasher but dry and put them in a dry room.

You could use cutlery dryer polisher machines with corncob powder. Do not use ceramics or similar and scrupulously avoid any abrasive liquid.

Do not use osmosis dishwasher machine.

In case of slight shading of color, or persistent limestone spots, clean with soft cloth and vinegar.

Manutenzione Alpacca e Acciaio Argentato

EPNS and EPSS Maintenance

ISTRUZIONI D'USO E DI MANUTENZIONE PER LA POSATERIA ED IL VASELLAME IN ACCIAIO ARGENTATO E ALPACCA ARGENTATA

Lavare accuratamente i prodotti nuovi Utilizzare per il lavaggio acqua calda ed un buon sapone neutro, risciacquare in seguito con abbondante acqua tiepida ed asciugare scrupolosamente tutti gli articoli. Non utilizzare per il lavaggio detersivi sintetici a base di cloro o prodotti comunque candeggianti. Pomice, paglietta d'acciaio, spugnette o panni impregnati di polveri abrasive devono essere altresì rigorosamente esclusi. Possono invece essere utilizzati detersivi non clorurati contenente farina fossile. È consigliato il lavaggio degli articoli argentati subito dopo il loro utilizzo. Qualora questo non fosse possibile è comunque importante non lasciare per caso di utilizzo degli articoli a pranzo articoli a cena, andrebbero lavati entro la mattina del giorno seguente). Nel caso fosse necessario un prelavaggio, questo deve essere fatto relativamente breve. Gli articoli non vanno infatti lasciati in ammollo quanto alcune sostanze contenute negli alimenti sono dannose per l'argentatura galvanica e ne alterano l'aspetto. Le lame dei coltelli prodotte con un pregiato acciaio inossidabile, sono sensibili agli attacchi corrosivi sviluppati dall'acido acetico, citrico, lattico ed in particolare da cloruro di sodio, presenti negli alimenti.

È importante, sia in fase di prelavaggio che durante il lavaggio, tenere separate le normali posate (cucchiai, forchette, cucchiaini...) dai coltelli e da altri oggetti metallici presenti in cucina.

Nel caso di lavaggio in lavastoviglie le posate devono essere inserite in cestelli verticali di plastica e tenute separate dai coltelli.

Asciugare accuratamente gli articoli con un panno morbido subito dopo il lavaggio, anche se il lavaggio è eseguito in lavastoviglie che prevede un ciclo di asciugatura automatica. Questo è necessario per evitare l'eventuale formazione di macchie dovute a depositi calcarei contenuti nell'acqua.

Non lasciare le posate nell'ambiente umido della lavastoviglie una volta terminato il ciclo di lavaggio, ma asciugarle e riporle in un ambiente asciutto.

Per lo stoccaggio degli articoli argentati si consiglia l'utilizzo di casse in plastica con coperchio che evitano il passaggio di aria e luce che faciliterebbero l'ossidazione dell'argento. È molto importante riporre gli articoli nella cassa perfettamente asciutti. Per evitare rigature si consiglia di non inserire alla rinfusa gli articoli ma di riporli ordinatamente e proteggere i vari strati con un panno morbido. Questo sistema di stoccaggio evita il rilavaggio degli articoli prima del loro utilizzo.

L'argento per sua natura è portato a solforarsi in presenza dell'aria e della luce, assumendo prima o poi una colorazione scura più o meno uniforme. Ciò avviene anche per il contatto con alcune sostanze presenti negli alimenti (limone, aceto, maionese o salse, tuorlo d'uovo...) ed in tal caso si può notare la formazione di macchie. Si tratta comunque di un fenomeno naturale che non danneggia il rivestimento d'argento degli articoli ma che ne altera l'aspetto. Per ridare all'argenteria il suo originale splendore sono disponibili in commercio alcuni prodotti antiossidanti specifici per la pulizia dell'argento e appositamente preparati da case qualificate. Si sconsiglia l'uso frequente della Burnishing Machine. Utilizzare al massimo 2/3 volte l'anno e con sfere di acciaio inox AISI 304 (per evitare magnetizzazioni dell'argento), di piccolo diametro (Ø ma x 3 mm). Successivamente gli articoli devono essere lucidati utilizzando tutolo di mais.

Un utilizzo più frequente della Burnishing Machine e l'utilizzo di sfere non idonee provoca inevitabilmente danni al prodotto con conseguente asportazione dell'argento dagli articoli e la corrosione dello stesso nella parte argentata magnetizzata.

INSTRUCTION OF USE AND MAINTENANCE OF SILVER PLATED STAINLESS STEEL AND ELECTRO-PLATED NICKEL SILVER CUTLERY AND HOLLOWWARE

Wash the new products carefully before use. Use hot water to wash them and a good neutral detergent; then, rinse out with tepid water and dry all the items thoroughly. When washing, do not use chlorinated detergents nor products containing bleach. Pumice, steel wool, sponges or cloths saturated with abrasive powders must be strictly avoided. However, detergents without chloride containing fossil flour can be used. The washing of plated items after use is recommended. In case that would not be possible, it is however important not to leave for more than 12 hours the dirty items in contact with food leftovers (e.g.: if the items are used at lunch, they should be washed within the evening; if the items are used at dinner, they should be washed within the following morning). In case a prewash was needed, it must be carried out just before the washing and for a relatively short time. In fact, the items must not be soaked in the washing solution for too long, since some substances contained in food are damaging for the electroplating and change its appearance. Knives blades are manufactured with a valuable stainless steel and are sensitive to the corrosion attacks developed by acetic, citric and lactic acid and in particular to sodium chloride present in food.

In case of washing in dishwasher, spoons and forks must be placed into plastic vertical baskets and kept separated from knives.

Dry the items thoroughly immediately after the washing with a soft cloth, even if your dishwasher has a dry cycle. That is necessary in order to avoid the possible formation of stains caused by calcareous deposits contained in the water.

Do not leave the cutlery in the humid environment of the dishwasher once the washing finishes; dry them and store them in a dry place.

For the storage of the silver plated items it is recommended the use of plastic boxes with cover, in order to avoid air and light that could facilitate the oxidation of silver. It is very important that the items are replaced in the box perfectly dry. In order to avoid scratches, it is recommended not to place the items in the box randomly, but to place them in an orderly way and protect the various layers with a soft cloth. This storage method avoids the rewashing of the items before they are used.

Silver by its nature tends to tarnish with air and light, getting unevenly darker sooner or later. This is due to the contact with some substances contained in food (lemon, vinegar, mayonnaise or sauces, egg yolk...) and in this case you can notice the formation of stains. However, this is a natural event that does not damage the silver coating of the items but simply changes their appearance. In order to restore its original splendor to silverware, there are available in the market some anti-oxidant products for silver cleaning and specially prepared by qualified companies.

The frequent use of the Burnishing Machine is not recommended. You can use it twice or three times a year maximum, with AISI 304 stainless steel spheres (to avoid silver magnetization), small diameter (Ø ma x 3 mm). After that, the items must be polished using corn powder.

A more frequent use of the Burnishing Machine and the use of non suitable spheres inevitably causes damages to the products with the consequent removal of the silver coating from the items and the corrosion of the same in the magnetized silvered part.

Manutenzione Acciaio

St. Steel Maintenance

ISTRUZIONI D'USO E DI MANUTENZIONE PER LA POSATERIA ED IL VASELLAME IN ACCIAIO

Lavare accuratamente i prodotti nuovi Utilizzare per il lavaggio acqua calda ed un buon sapone neutro, risciacquare in seguito con abbondante acqua tiepida ed asciugare scrupolosamente tutti gli articoli. Non utilizzare per il lavaggio detersivi sintetici a base di cloro o prodotti comunque candeggianti. Pomice, paglietta d'acciaio, spugnette o panni impregnati di polveri abrasive devono essere altresì rigorosamente esclusi. Possono invece essere utilizzati detersivi non clorurati contenente farina fossile. È consigliato il lavaggio degli articoli subito dopo il loro utilizzo. Qualora questo non fosse possibile è comunque importante non lasciare per caso di utilizzo degli articoli a pranzo articoli a cena, andrebbero lavati entro la mattina del giorno seguente). Nel caso fosse necessario un prelavaggio, questo deve essere fatto relativamente breve. Gli articoli non vanno infatti lasciati in ammollo quanto alcune sostanze contenute negli alimenti sono dannose e ne alterano l'aspetto. Le lame dei coltelli prodotte con un pregiato acciaio inossidabile, sono sensibili agli attacchi corrosivi sviluppati dall'acido acetico, citrico, lattico ed in particolare da cloruro di sodio, presenti negli alimenti.

È importante, sia in fase di prelavaggio che durante il lavaggio, tenere separate le normali posate (cucchiai, forchette, cucchiaini...) dai coltelli e da altri oggetti metallici presenti in cucina.

Nel caso di lavaggio in lavastoviglie le posate devono essere inserite in cestelli verticali di plastica e tenute separate dai coltelli.

Asciugare accuratamente gli articoli con un panno morbido subito dopo il lavaggio, anche se il lavaggio è eseguito in lavastoviglie che prevede un ciclo di asciugatura automatica. Questo è necessario per evitare l'eventuale formazione di macchie dovute a depositi calcarei contenuti nell'acqua.

Non lasciare le posate nell'ambiente umido della lavastoviglie una volta terminato il ciclo di lavaggio, ma asciugarle e riporle in un ambiente asciutto.

INSTRUCTION OF USE AND MAINTENANCE OF STAINLESS STEEL CUTLERY AND HOLLOWWARE

Wash the new products carefully before use. Use hot water to wash them and a good neutral detergent; then, rinse out with tepid water and dry all the items thoroughly. When washing, do not use chlorinated detergents nor products containing bleach. Pumice, steel wool, sponges or cloths saturated with abrasive powders must be strictly avoided. However, detergents without chloride containing fossil flour can be used. The washing of items after use is recommended. In case that would not be possible, it is however important not to leave for more than 12 hours the dirty items in contact with food leftovers (e.g.: if the items are used at lunch, they should be washed within the evening; if the items are used at dinner, they should be washed within the following morning). In case a prewash was needed, it must be carried out just before the washing and for a relatively short time. In fact, the items must not be soaked in the washing solution for too long, since some substances contained in food are damaging for the electroplating and change its appearance. Knives blades are manufactured with a valuable stainless steel and are sensitive to the corrosion attacks developed by acetic, citric and lactic acid and in particular to sodium chloride present in food.

In case of washing in dishwasher, spoons and forks must be placed into plastic vertical baskets and kept separated from knives.

Dry the items thoroughly immediately after the washing with a soft cloth, even if your dishwasher has a dry cycle. That is necessary in order to avoid the possible formation of stains caused by calcareous deposits contained in the water.

Do not leave the cutlery in the humid environment of the dishwasher once the washing finishes; dry them and store them in a dry place.



ABERT S.p.A.

Divisione Broggi 1818

Via Don P. Mazzolari, 17 25050 Passirano (BS) Italy

T. +39 030 6853601-602

F. +39 030 6853610

info@broggi.it